

# TAG

PROMOTIONAL GUIDE **.23.24**





**T A G**

PROMOTIONAL GUIDE

**.23.24**

# INDICE **GIFT** **E TIME**

## **GIFT 01** **PENNE, MATITE E** **SET DA SCRITTURA**

pag. 4

Astucci  
Penne e matite  
Penne ecologiche  
Articoli da cancelleria  
Set da scrittura

## **GIFT 02** **UFFICIO** **E LAVORO**

pag. 58

Cavallari Studio  
Borse business  
Articoli da ufficio  
Articoli da cancelleria  
Articoli smart working

## **GIFT 03** **BORRACCE** **E TAZZE**

pag. 114

Borracce in alluminio  
Borracce in acciaio  
Borracce in tritan  
Lunch box  
Tazze ceramica e vetro

## **GIFT 04** **RISTORAZIONE** **E CUCINA**

pag. 146

Accessori per la cucina  
Buste portavino  
Grembiuli e sinalini  
Cavatappi  
Apribottiglie

## **GIFT 05** **SHOPPERS**

pag. 166

Borse termiche  
Shoppers in carta avana  
Shoppers in carta kraft  
Shoppers in tnt  
Shoppers in cotone  
Shoppers delivery  
Shoppers polipropilene

## **GIFT 06** **ZAINI, BORSE** **E SACCHE**

pag. 250

Cavallari Studio  
Borse sport  
Borse tempo libero  
Sacche zaino  
Tracolle

## **GIFT 07** **VIAGGIO E** **TEMPO LIBERO**

pag. 288

Accessori da spiaggia  
Accessori per bricolage  
Borselli  
Kit da viaggio  
Portadocumenti  
Trolley

## **GIFT 08** **PORTACHIAVI**

pag. 310

Antistress in eva  
Gancio per borsa  
Portachiavi in legno  
Portachiavi in metallo  
Portachiavi in plastica  
Portachiavi multiuso

## **GIFT 09** **ACCENDINI** **E ACCESSORI**

pag. 328

Accendigas  
Accendini piezoelettrici  
Accendini elettronici  
Posacenere tascabili

## **GIFT 10** **TECNOLOGIA**

pag. 334

Accessori smartphone  
Cuffie e auricolari  
Powerbank e caricatori  
Smartwatch  
Speaker  
USB flash drive

## **GIFT 11** **ACCESSORI** **AUTO**

pag. 360

Accessori auto  
Dischi orari  
Kit targa  
Portadocumenti  
Portatarga  
Portatessere

## **GIFT 12** **OMBRELLI E** **IMPERMEABILI**

pag. 386

Cavallari  
Ombrelli automatici  
Ombrelli pieghevoli  
Impermeabili

## **GIFT 13** **TESSILE E** **ABBIGLIAMENTO**

pag. 402

Abbigliamento sport  
Casacche  
Cappelli e bandane  
Felpe e giubbini  
NAKOTA  
T-Shirt e polo

## **GIFT 14** **TELI E** **ASCIUGAMANI**

pag. 452

Asciugamani mare  
Asciugamani microfibra  
Asciugamani in cotone  
Asciugamani palestra

## **TIME 01-05** **CALENDARI** **2024**

pag. 3

Olandesi fluo  
Olandesi tecnici  
Calendari da tavolo  
Calendari avoriati  
Calendari da scrivania  
Silhouette

## **TIME 06-09** **AGENDE 2024** **E NOTES**

pag. 96

Agende borsello  
Agende flessibili  
Agende gommato  
Agende portafoglio  
Agende termoviranti  
Parure e notes

# TECNICHE DI **STAMPA**

**CA**

## **STAMPA A CALDO**

È un processo di stampa che trasferisce pellicole sia metallizzate che neutre, su oggetti con superfici regolari e di composizione varia. La stampa a caldo è applicabile su tutte le superfici piane, tonde, ellittiche. La stampa a caldo è l'unico processo di stampa capace di apportare brillantezza ed effetti metallici.

**DI**

## **STAMPA DIGITALE**

sistema basato su tecnologie che permettono l'invio di file digitali da computer o altro dispositivo elettronico direttamente alla stampante. I file, trasmessi possono essere stampati su diversi materiali, come carta, cartone, pannelli rigidi e tessuti

**IN**

## **INCISIONE**

Si definisce anche tecnica tecnica artistica, attraverso la pressione di un laser, il materiale viene inciso e bruciato ottenendo un risultato duraturo e resistente.

**SE**

## **STAMPA SERIGRAFICA**

Tecnica a più colori, è molto diffusa e non particolarmente complessa spesso usata nelle pubblicità e per personalizzare gadget o articoli da regalo. L'inchiostro passa attraverso un tessuto nell'area prestabilita e compone l'immagine voluta.

**SU**

## **STAMPA SUBLIMATICA**

Consiste in una modalità di stampa indiretta che prevede il trasferimento di inchiostri sublimatici termosensibili permanenti, il vantaggio di questa tecnica è nei dettagli e nelle sfumature di colore brillanti e ben definite.

**TA**

## **STAMPA TAMPOGRAFICA**

Una tecnica indiretta che prevede attraverso l'utilizzo di un tampone, spesso in silicone, il trasferimento dell'inchiostro da una piastra in acciaio sulla superficie.

**UV**

## **STAMPA UV**

La stampa a UV LED è un tipo di stampa digitale, che consiste nell'applicazione dell'inchiostro sui materiali, con la particolarità che l'essiccazione è quasi immediata grazie alla luce UV delle lampade a LED applicate sulle macchina da stampa.

# 01.

PENNE,  
MATITE  
E SET DA  
SCRITTURA



## PENNE **ANTIBATTERICHE**

**CONDIVIDI LA TUA PENNA IN SICUREZZA**

Gli articoli conformi alla normativa ISO22196, sono prodotti con materiali che riducono la diffusione dei batteri garantendo maggiore sicurezza al contatto.

**ZD253 VELVET**

astuccio floccato  
effetto velluto  
tasca 1 posto



3x16 cm ca  
100/5000 SE



BL

GR

NE

**Astuccio universale**  
effetto velluto

**ZD260 FLYER**

astuccio in carta riciclata  
tasca 1 posto



4x15,5 cm ca  
50/500 SE



**SUSTAINABLE  
SELECTION**



NA

NE

**Astuccio universale**  
in carta riciclata



**PD025 ALEXIA**

penna in alluminio, rivestimento in lacca metallizzata, refill in metallo  
custodia in tinta, astuccio in cartoncino incluso



☑ Ø 1,35xh13,5 cm ca ☑ custodia: Ø 2,45xh15 cm ca  
📦 10/200 🏠 IN SE TA UV

ALU. ALUMINIUM



BL



GR



OR



SI



BO



VL

**PD026 ALEXIA SHOCK**

penna in alluminio, rivestimento in lacca lucida, refill in metallo  
custodia in tinta, astuccio in cartoncino incluso



☑ Ø 1,35xh13,5 cm ca ☑ custodia: Ø 2,45xh15 cm ca  
📦 10/200 🏠 IN SE TA UV

ALU. ALUMINIUM



AR



BI



BL



GI



NE



RO



**PD011 CHROME**

penna in alluminio  
refill jumbo nero



- ☐ Ø 1xh14 cm ca
- 📦 50/1000
- 🔗 IN SE TA UV

**ALU** ALUMINIUM



REFILL JUMBO



BI BL BS GR GS NE RO SI VE

**PD030 AUTHOR**

penna in alluminio, texture effetto diamante  
refill jumbo nero



- ☐ Ø 1xh14 cm ca
- 📦 50/500
- 🔗 IN SE TA UV

**ALU** ALUMINIUM

Texture  
Effetto  
Diamantato



REFILL JUMBO BL GS RO SI VE

### PD022 CORK SET

set penne con corpo in sughero  
 minuterie in metallo, refill nero  
 penna a sfera con meccanismo a rotazione  
 penna roller con tappo in metallo  
 astuccio in sughero



- ☑ astuccio: 16x6x3 cm ca
- ☑ penne: Ø 1xh13 cm ca
- 📦 10/200 🌱 SE TA UV



**2 PENNE:**  
 PENNA A SFERA  
 E ROLLER

### PD523 BAMBOO TWIST

penna in bamboo  
 minuterie in metallo, clip silver  
 refill nero



- ☑ Ø 1,05xh14 cm ca
- 📦 100/1000 🌱 SE TA UV



### PD529 CORK TWIST

penna in sughero e metallo  
 minuterie in metallo, clip silver,  
 refill nero



- ☑ Ø 1,05xh14 cm ca
- 📦 100/1000 🌱 SE TA UV



## PENNA IN METALLO FUSTO SOFT TOUCH



### PD032 SILKY

penna a sfera in metallo, fusto in materiale soft touch, minuterie cromate, refill nero adatto per incisione a laser

NEW!



☑ Ø 1x14 cm ca

📦 50/1000 🌐 IN SE TA UV



AR

AZ

BI

BL

BO

GI

GR

NE

RO

VE

VL

RY

PENNA IN  
METALLO  
**FUSTO  
SOFT  
TOUCH**



**PD031 VELVET**

penna a sfera in metallo, fusto in materiale soft touch, minuterie cromate, refill nero adatto per incisione a laser



☑ Ø 1,1xh14 cm ca  
📦 50/500 🏠 IN SE TA UV

**NEW!**



AR

AZ

BI

BL

GR

NE

VE

RO

**PD045 IMPERIAL**

penna in metallo, refill nero  
fusto in metallo satinato  
rifinitura opaca  
minuterie in metallo grigio



☑ Ø 1,1xh14 cm ca  
📦 50/500 📏 IN SE TA UV

METALLO SATINATO  
**MINUTERIE GRIGIE**

**NEW!**

BI

BL

GR

NE

RO

SI

VE

**PD046 MAJESTIC**

penna in metallo, refill nero  
fusto in metallo satinato  
rifinitura opaca  
minuterie in metallo cromato



☑ Ø 1,1xh14 cm ca  
📦 50/500 📏 IN SE TA UV

METALLO SATINATO  
**MINUTERIE CROMATE**

**NEW!**

AZ

BI

BL

GR

NE

RO

VE

### PD048 KING FLASH

penna in metallo, refill nero  
fusto colore metallizzato  
minuterie in metallo cromato

NEW!



☐ Ø 1,1xh14 cm ca  
📦 50/500 ⊕ IN SE TA UV

FUSTO IN METALLO  
**CROMATO**



AZ BL BS GR GS RO SI VE

### PD051 KING

penna in metallo  
refill nero  
fusto laccato lucido  
minuterie in metallo cromato

NEW!



☐ Ø 1,1xh14 cm ca  
📦 50/500 ⊕ IN SE TA UV

FUSTO IN METALLO  
**LACCATO LUCIDO**



AR BI BL GR NE RO RY SI VE

### PD062 ROSE GOLD

penna in metallo, refill nero  
fusto in materiale soft touch  
minuterie in metallo oro rosa



☐ Ø 1,1xh14 cm ca  
📦 50/1000 📦 IN SE TA UV

**NEW!**



MINUTERIE  
IN METALLO  
**ORO ROSA**



BI

BL

GR

NE

RO

VE

### PD063 IRIS

penna in alluminio  
refill jumbo nero



☐ Ø 1,05xh14 cm ca  
📦 50/500 📦 IN SE TA UV



AR

BI

BL

NE

RO

SI

VL



REFILL JUMBO



ALUMINIUM



PENNA IN METALLO  
CON FINITURA OPACA

**PD083 MONARCH**

penna a sfera in metallo, fusto con rifinitura opaca, minuterie cromate, refill nero



- ☑ Ø 1x14 cm ca
- 📦 50/1000 🔄 IN SE TA UV

**NEW!**



AR AZ BI BL GI GR NE OR SI VE VL RO



**PD041 REGENT**

penna a sfera in metallo, refill nero  
fusto matto satinato  
rifiniture metallo grigio  
gommino touch



☐ Ø 1,1xh14 cm ca  
☐ 50/500 ☐ IN SE TA UV

**NEW!****PD058 EMIR**

penna in metallo, refill nero  
minuterie in metallo nero  
fusto in materiale soft touch  
gommino touch



☐ Ø 1,1xh14 cm ca  
☐ 50/500 ☐ IN SE TA UV

**NEW!**



### PD043 SULTAN

penna a sfera in metallo  
fusto in materiale gommato  
grip in bamboo, gommino touch  
anello trasparente, refill nero  
minuterie in metallo cromato



- ☐ Ø 1,1xh14 cm ca
- 📦 50/500
- 🔌 IN SE TA UV



TOUCH  
SCREEN



FUSTO  
SOFT TOUCH



### PD044 EMPEROR

penna a sfera in metallo  
fusto in materiale gommato  
grip in bamboo, gommino touch  
anello trasparente, refill nero  
minuterie in metallo grigio



- ☐ Ø 1,1xh14 cm ca
- 📦 50/500
- 🔌 IN SE TA UV



TOUCH  
SCREEN



FUSTO  
SOFT TOUCH



FUSTO IN  
MATERIALE  
GOMMATO



# SPECIAL LASER

L'incisione a laser permette di ottenere il logo dello stesso colore del gommino touch



gommino touch

## PD074 BLACK TOUCH

penna in metallo  
gommino touch  
refill nero



- ☐ Ø 1x14 cm ca
- 📦 50/500
- 📦 IN SET A UV



BL

OR

RO

SI

VE

VL

BI

# SPECIAL LASER

L'incisione a laser permette di ottenere il logo dello stesso colore del gommino touch



PD050BL

PD055BL

## PD050 WHITE LASER

penna in metallo  
gommino touch  
refill jumbo nero



- ☐ Ø 1,1xh15 cm ca
- 📦 50/500
- ⊕ IN SE TA UV



NE

OR

RO

SI

VL

## PD055 BLACK LASER

penna in metallo  
gommino touch  
refill jumbo nero



- ☐ Ø 1,1xh15 cm ca
- 📦 50/500
- ⊕ IN SE TA UV



BI

OR

RO

SI

VL

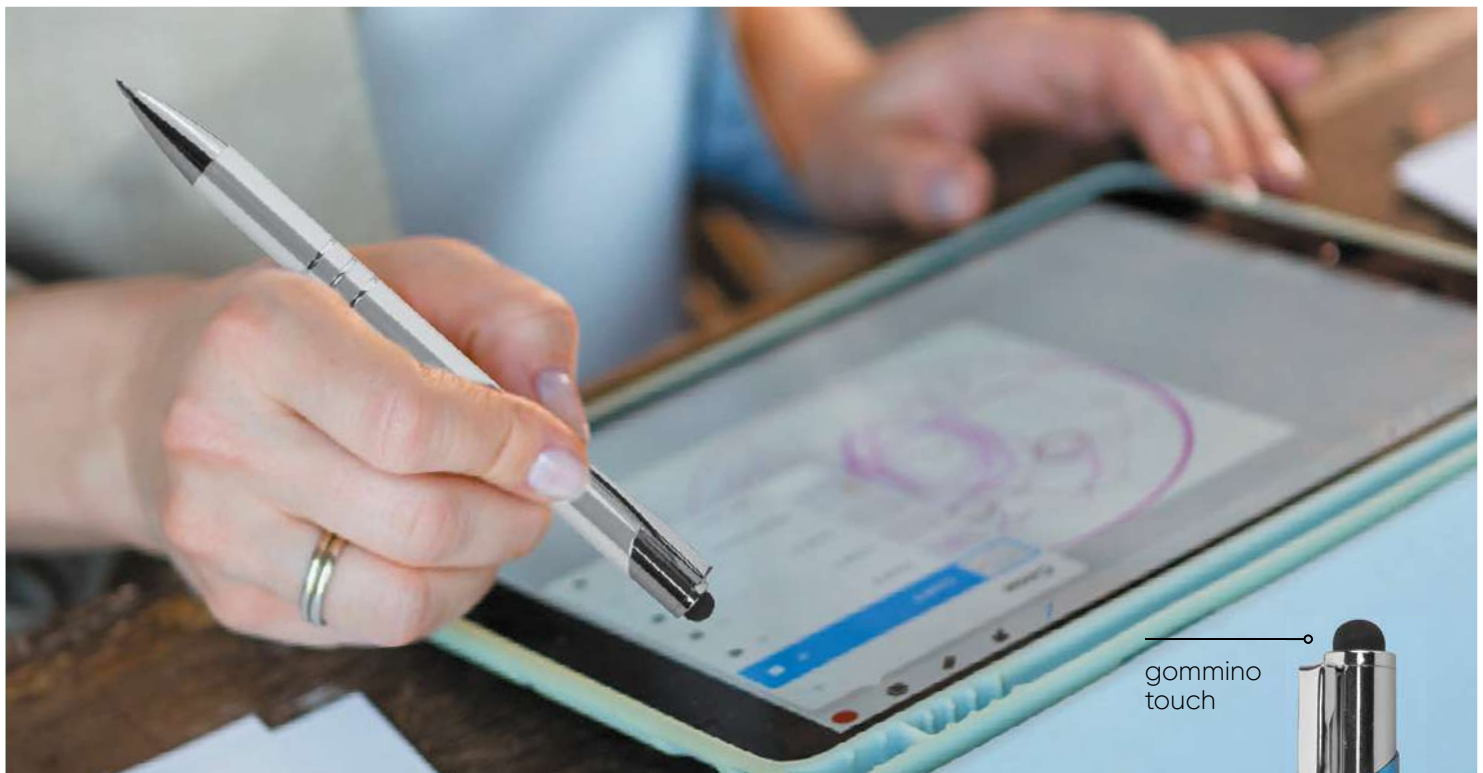

## PD076 CHROME PLUS

penna in alluminio, gommino touch, refill jumbo nero



☑️ Ø 1x14 cm ca  
 📦 50/1000 📦 IN SE TA UV

ALU ALUMINIUM



BI



BL



NE

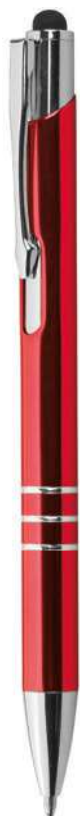

RO



SI



VE

BC

### PD088 IMPACT

penna in alluminio, refill nero  
gommino touch



☐ Ø 1xh14 cm ca  
📦 50/500 🌐 IN SE TA UV



—  
○ gommino touch

### PD072 CLICK

penna in alluminio  
gommino touch  
refill nero  
meccanismo a rotazione



☐ Ø 0,9xh13,2 cm ca  
📦 50/500 🌐 IN SE TA UV



## PENNE SPRAY ANTIBATTERICHE

Gli articoli conformi alla normativa **ISO22196** sono prodotti con materiali che riducono la diffusione dei batteri garantendo maggiore sicurezza al contatto.

### CONTENITORE SPRAY

Facile da ricaricare con alcool o liquidi sanificanti.



### PD071 JUKE SPRAY

penna spray in plastica antibatterica, contenitore per liquidi 4 ml, meccanismo a rotazione, grip in gomma, refill nero



☐ Ø1,4xh16 cm ca

📦 100/1000 🔄 TA UV



AR

AZ

BI

BL

IT

NE

VE

RO

## PENNE SPRAY ANTIBATTERICHE

Gli articoli conformi alla normativa **ISO22196** sono prodotti con materiali che riducono la diffusione dei batteri garantendo maggiore sicurezza al contatto.



PLASTICA  
ANTIBATTERICA



TOUCH  
SCREEN

gommino  
touch

### PD079 JUKE SPRAY TOUCH

penna spray in plastica antibatterica, contenitore per liquidi 4 ml, meccanismo a rotazione, minuterie in metallo, gommino touch, refill nero



☐ Ø 1,4xh16 cm ca

📦 100/1000 🏷️ SE TA UV



AZ

AR

BI

BL

IT

NE

RO

VE



### PD080 SPRAY

penna in plastica antibatterica  
 contenitore per liquidi 7 ml  
 meccanismo a rotazione  
 minuterie in metallo  
 refill nero



☑ Ø 1,4xh15,5 cm ca  
 ☑ 100/1000 ☑ TA UV



PLASTICA  
 ANTIBATTERICA



BI BL BO NE OR SI VE



BI BL BO NE OR SI VE

### PD082 SPRAY TOUCH

penna spray in plastica  
 antibatterica  
 contenitore per liquidi 4 ml  
 meccanismo a rotazione  
 minuterie in metallo  
 gommino touch, refill nero



☑ Ø 1,4xh15,5 cm ca  
 ☑ 100/1000 ☑ TA UV



PLASTICA  
 ANTIBATTERICA



TOUCH  
 SCREEN

gommino  
 touch



# POINT

Penna touch screen in plastica antibatterica

gommino touch

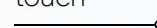

## PD089 POINT

penna in plastica antibatterica  
gommino touch, refill jumbo nero



☐ Ø 1,26x14,5 cm ca  
☒ 100/1000 ☒ SE TA UV



PLASTICA ANTIBATTERICA



AR

AZ

BI

BL

GI

NE

RY

SI

VL

RO



gommino touch



**PD090 STYLUS**

penna in plastica antibatterica  
refill nero, meccanismo a rotazione  
gommino touch



☑ Ø 1,25xh14,5 cm ca  
☑ 100/1000 ☑ SE TA UV



PLASTICA ANTIBATTERICA



gommino touch



**PD091 FLASH PLUS**

penna in plastica antibatterica  
meccanismo a rotazione, refill nero  
gommino touch, grip in gomma



☑ Ø 1,25xh13,6 cm ca  
☑ 100/1000 ☑ TA UV



PLASTICA ANTIBATTERICA



TOUCH SCREEN

Penne touch screen in plastica antibatterica



PD092BL

PD104AZ

**PD092 ADVANCE**

penna in plastica antibatterica  
grip in gomma  
meccanismo a rotazione  
refill nero, gommino touch



- ☐ Ø 1,25xh13,6 cm ca
- 📦 100/1000
- ⊕ SE TA UV



BI

GR

NE

RO

SI

VE

**PD104 HOLLY**

penna in plastica antibatterica  
grip in gomma  
meccanismo a rotazione  
refill nero, gommino touch



- ☐ Ø 1,25xh13,6 cm ca
- 📦 100/1000
- ⊕ SE TA UV



AR

BI

BL

GI

RO

VL



gommino touch

**PD108 FUNNY**

penna in plastica antibatterica  
gommino touch, refill nero



☑ Ø 1,05xh14 cm ca

📦 100/1000 🌐 SE TA UV



PLASTICA  
ANTIBATTERICA



TOUCH  
SCREEN



AR

AZ

BI

GF

NE

RO

RY

VE

VF

BL

# Penna con gommino touch e supporto per smartphone

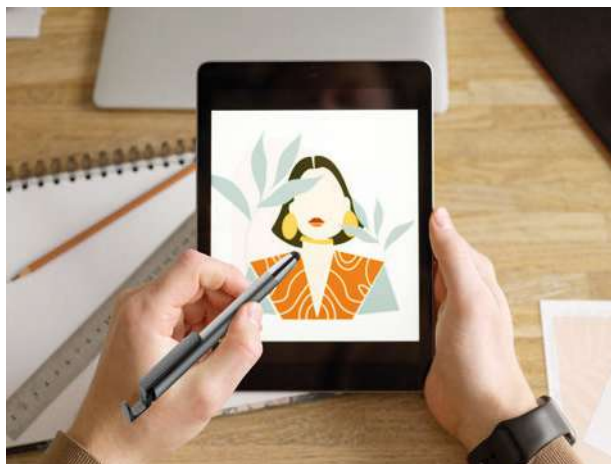

## PD128 SMARTPEN

penna in plastica antibatterica, gommino touch supporto per smartphone, refill nero



Ø 1,2xh14 cm ca  
50/1000 SE TA UV



BL GS NE OR RO SI VE BI

**PD173 WANDA**

penna in plastica  
antibatterica  
minuterie in metallo  
refill jumbo nero



- ☑ Ø 1,15x14 cm ca
- 📦 100/1000
- ⊕ SE TA UV



PLASTICA  
ANTIBATTERICA



REFILL JUMBO



AR

AZ

BI

BL

GI

IT

NE

RO

SI

VL

**PD207 PORTRAIT**

penna in plastica  
antibatterica  
minuterie in metallo cromato  
refill jumbo nero



- ☑ Ø 1,05x14 cm ca
- 📦 100/1000
- ⊕ SE TA UV



PLASTICA  
ANTIBATTERICA



REFILL JUMBO



BI

BL

NE

RO

RY

VE

VL

AZ



NEW!

base circolare  
con adesivo e  
tappo nero



### PD154 STANCE

stilofofo orientabile con spirale  
fusto in plastica antibatterica  
minuterie in plastica nera  
base adesiva di forma circolare, refill nero



- ☑ penna: Ø 1xh14 cm ca
- ☑ base: Ø 6,5 cm ca
- 📦 50/400    🏠 SE TA UV

BL

**Stilofofo orientabile**  
con base  
adesiva



RO

### PD152 UFO

stilofofo orientabile in plastica antibatterica,  
base adesiva Ø 3 cm ca, penna con spirale,  
fusto bianco, refill nero



- ☑ Ø 1,3xh13,5 cm ca
- 📦 50/400    🏠 SE TA UV



AR

BL

VE



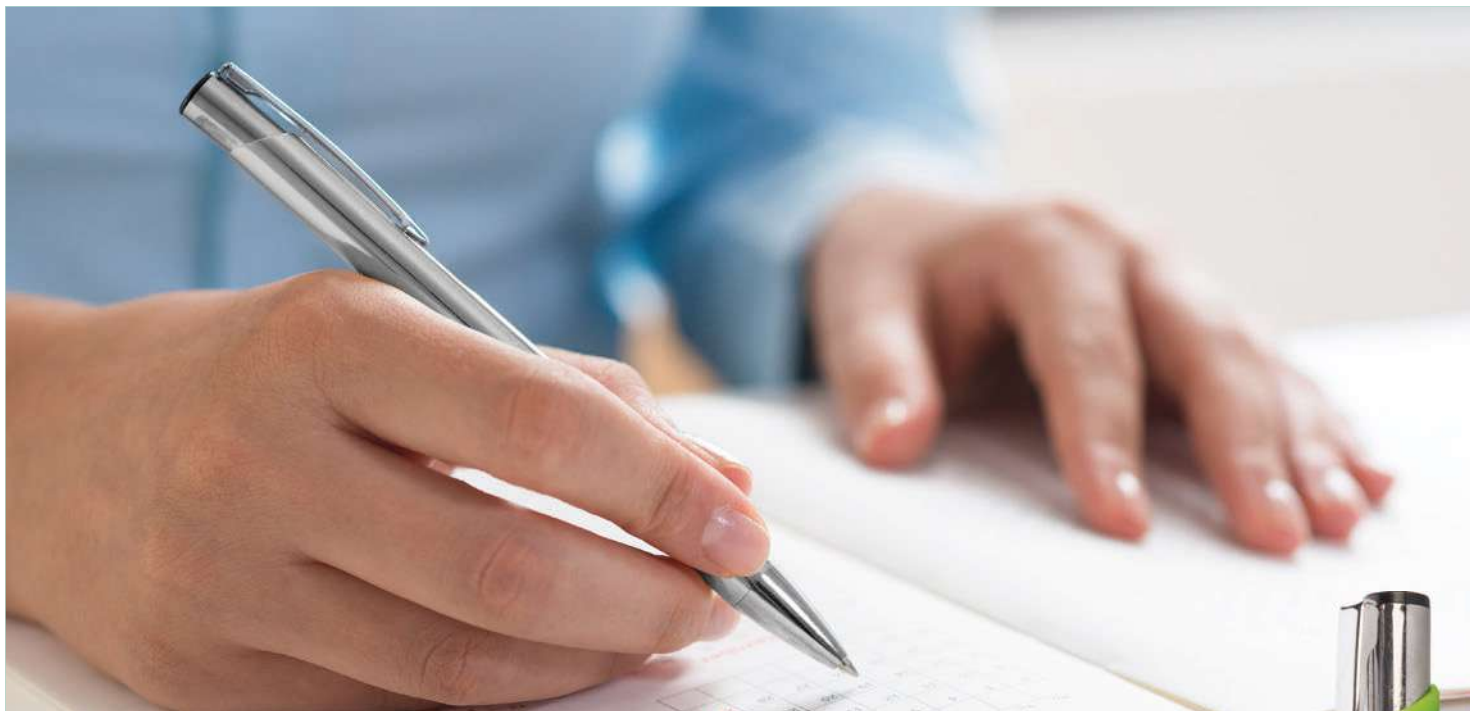

**PD194 VIVID**

penna in plastica antibatterica  
minuterie in metallo cromato, refill jumbo nero



☑ Ø 1,05xh14 cm ca  
📦 100/1000 📦 SE TA UV



AR AZ BI BL BO BS GI NE RO SI VI VL

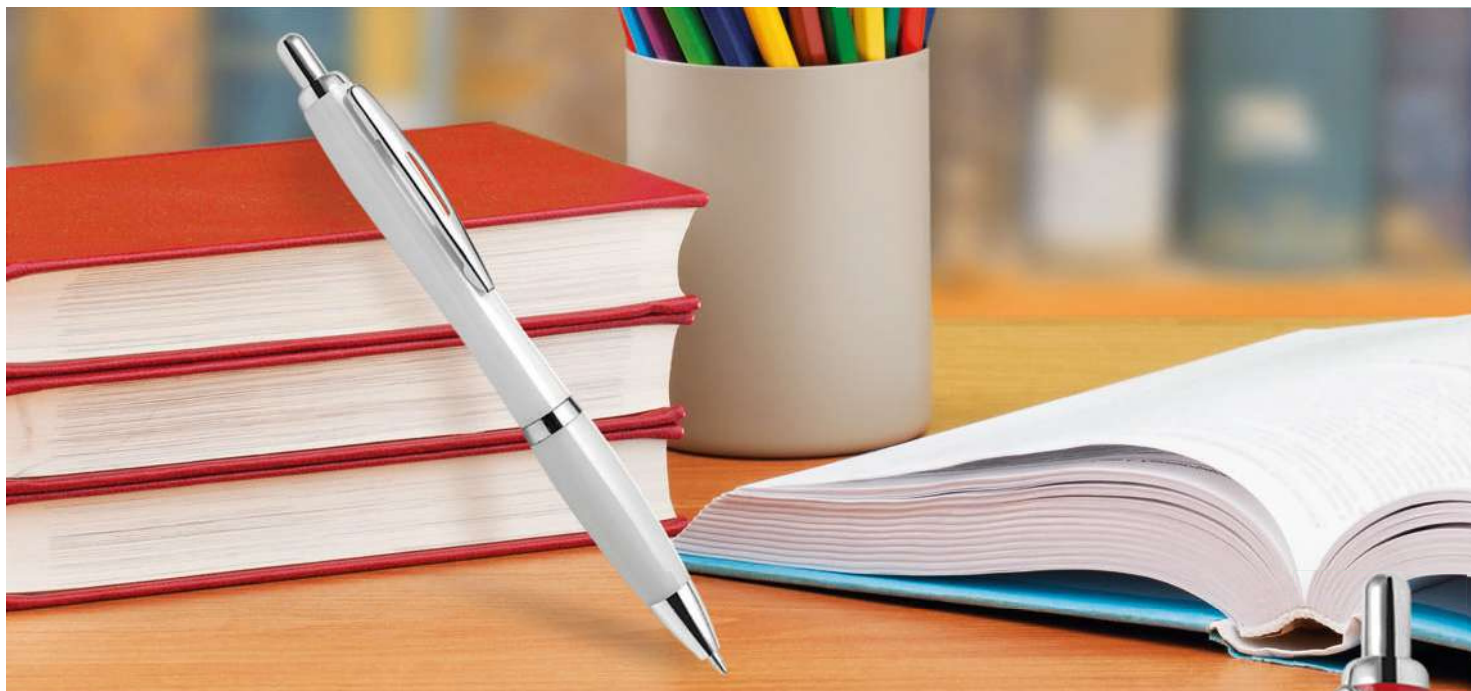

**PD209 JUKE COLOR**

penna in plastica antibatterica  
minuterie in metallo cromato, refill jumbo nero



☑ Ø 1,25xh14 cm ca  
☑ 100/1000 ☑ TA UV



AR AZ BI BL GI GR IT NE VE VI VL RO

**PD218 JUKE**

penna in plastica  
antibatterica  
minuterie in metallo  
refill jumbo nero



- ☑ Ø 1,25xh14 cm ca
- 📦 100/1000
- ⊕ TA UV



**PLASTICA  
ANTIBATTERICA**



REFILL JUMBO

AR

AZ

BI

BL

GI

GR

NE

RO

VE

VL



AR

BL

NE

RO

SI

VE

**PD343 JUKE SILVER**

penna in plastica  
antibatterica  
grip in gomma  
refill jumbo nero



- ☑ Ø 1,25xh14 cm ca
- 📦 100/1000
- ⊕ TA UV



**PLASTICA  
ANTIBATTERICA**



REFILL JUMBO



VE

**PD335 ARROW**

penna in plastica antibatterica  
meccanismo a rotazione  
minuterie in metallo, refill nero



☐ Ø 1,1xh14 cm ca  
📦 100/1000 📦 SE TA UV



REFILL JUMBO



AR AZ BI BL BO GI IT NE

Colorazioni metallizzate per le varianti:

**MB:** metallic blue      **MG:** metallic green  
**MO:** metallic orange    **MR:** metallic red



RO SI VL MB MG MO MR



**PD346 VANEAS SHOCK**

penna in plastica antibatterica, refill jumbo nero



☐ Ø 1,23xh14 cm ca  
 ☐ 100/1000 ☐ SE TA UV



**PLASTICA  
 ANTIBATTERICA**



REFILL JUMBO



### PD348 MIPITA

penna in plastica  
antibatterica  
minuterie in plastica cromata  
refill jumbo nero



- ☑ Ø 1,1xh14,5 cm ca
- 📦 50/1000
- ⊕ SE TA UV



PLASTICA  
ANTIBATTERICA



REFILL JUMBO



AR BI BL GI NE RO RY SI VE VL

### PD353 STRIPES

penna in plastica antibatterica  
minuterie in metallo  
refill jumbo nero



- ☑ Ø 1,08xh14 cm ca
- 📦 100/1000
- ⊕ SE TA UV



PLASTICA  
ANTIBATTERICA



AR AZ BI BL IT NE RO VE



REFILL JUMBO

**PD384 MARY**

penna in plastica  
antibatterica  
grip in gomma  
minuterie trasparenti  
refill nero



- ☑ Ø 1,05xh15 cm ca
- 📦 50/1000
- ⊕ SE TA UV



**PLASTICA  
ANTIBATTERICA**



AR AZ BI BL GI NE RO RY VE VL

**PD388 JANE**

penna in plastica  
antibatterica  
grip in gomma  
minuterie trasparenti  
refill nero



- ☑ Ø 1,05xh15 cm ca
- 📦 50/1000
- ⊕ SE TA UV



**PLASTICA  
ANTIBATTERICA**

AR AZ BI BL GI IT RO RY VE VL



RO

### PD480 MARTA

penna in plastica antibatterica  
corpo e clip monocolore, refill nero



☐ Ø 1,05x14 cm ca

☐ 100/1000 ☐ SE TA UV



PLASTICA  
ANTIBATTERICA

FLUO



AF



AZ



BI



BL



FX



GF

FLUO

FLUO



NE



RY



VE



VI



VF



VL





**PD485 SOFIA**

penna in plastica antibatterica  
refill nero



☐ Ø 1,05x14 cm ca  
📦 100/1000 📦 SE TA UV



FLUO



AR



BL



FX



GI



NE

FLUO

FLUO



RO



RY



VE



VL



**PD209**  
JUKE COLOR

penna in plastica  
minuterie in metallo  
refill jumbo nero



- ☞ Ø 1,25xh14 cm ca
- 📦 100/1000
- ⊕ TA UV



**PD071**  
JUKE SPRAY

penna in plastica  
antibatterica  
meccanismo a rotazione  
contenitore liquidi 4 ml  
refill nero



- ☞ Ø 1,4xh16 cm ca
- 📦 100/1000
- ⊕ TA UV



PLASTICA  
ANTIBATTERICA



**PD335**  
ARROW

penna in plastica  
antibatterica  
meccanismo a rotazione  
minuterie in metallo  
refill nero



- ☞ Ø 1,1xh14 cm ca
- 📦 100/1000
- ⊕ SE TA UV



PLASTICA  
ANTIBATTERICA



**PD353**  
STRIPES

penna in plastica  
minuterie in metallo  
refill jumbo nero



- ☞ Ø 1,08xh14 cm ca
- 📦 100/1000
- ⊕ SE TA UV



**PD388**  
JANE

penna in plastica,  
antibatterica,  
grip in gomma, refill nero



- ☞ Ø 1,05xh15 cm ca
- 📦 50/1000
- ⊕ SE TA UV



PLASTICA  
ANTIBATTERICA

## ABBINA LA PENNA AL NOTES

Mini penna h 16 cm ca abbinabile al notes tascabile PB607 f.to 9xh14 cm ca dotati di elastico portapenne.

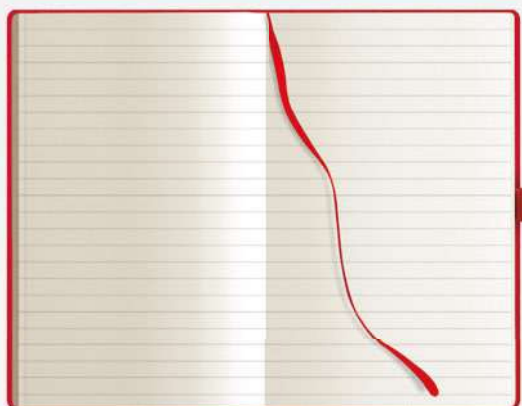

interno avorio a righe

### PD488 MIGNON

mini penna in plastica, refill nero, abbinabile al notes PB607



☑ Ø 0,8xh11,6 cm ca  
📦 100/1000 🌐 SE TA UV



AR AZ BI BL BO NE RO SI

### PB607 NOTES PEN CLASS

notes in midi cartonato, portapenne  
160 pagine a righe carta avorio



☑ Ø 9xh14 cm ca  
📦 20/80 🌐 SE UV



BA BI BL  
BO NE RO

### PD418 ROOT

penna a sfera in plastica e paglia di frumento  
minuterie cromate, refill nero



☐ Ø 1xh14 cm ca  
📦 100/1000 🏭 SE TA UV



 PAGLIA DI FRUMENTO  
E PLASTICA



AR

BL

EC

GI

VE



AR

BL

EC

GI

VE

### PD419 STIGMA

penna a sfera in plastica e paglia di frumento  
minuterie cromate, gommino touch, refill nero



☐ Ø 1xh14 cm ca  
📦 100/1000 🏭 SE TA UV

 PAGLIA DI FRUMENTO  
E PLASTICA



**PD491 WHEAT**

penna in paglia di frumento, refill nero



☑ Ø 1x14 cm ca

📦 50/1000 🌐 TA UV

**SUSTAINABLE SELECTION**

Penne realizzate in materiali ecologici: paglia di frumento, carta riciclata e sughero



AZ

BL

EC

GI

RS

VE



AZ

BL

EC

GI

RS

VE

**PD494 PAPER WHEAT**penna in carta riciclata, refill nero  
minuterie in paglia di frumento

☑ Ø 1x13,5 cm ca

📦 50/1000 🌐 SE TA UV



### PD495 LEAF

penna in carta, refill nero  
minuterie in paglia di frumento



☑ Ø 1,1xh14 cm ca  
📦 50/1000 🏠 SE TA UV



AZ

BL

EC

GI

RO

VE



AR

AZ

BL

GI

RO

VE

VL



### PD517 STEM

penna in carta  
minuterie in plastica colorata  
gommino touch, refill nero



☑ Ø 1,05xh14 cm ca  
📦 100/1000 🏠 SE TA UV



**PD508 GEA**

penna in sughero, refill nero  
minuterie in paglia di frumento



☐ Ø 1,2xh13,5 cm ca  
📦 50/1000 🌐 SE TA UV



PAGLIA DI FRUMENTO  
E SUGHERO



AZ

BL

EC

GI

RS

VE

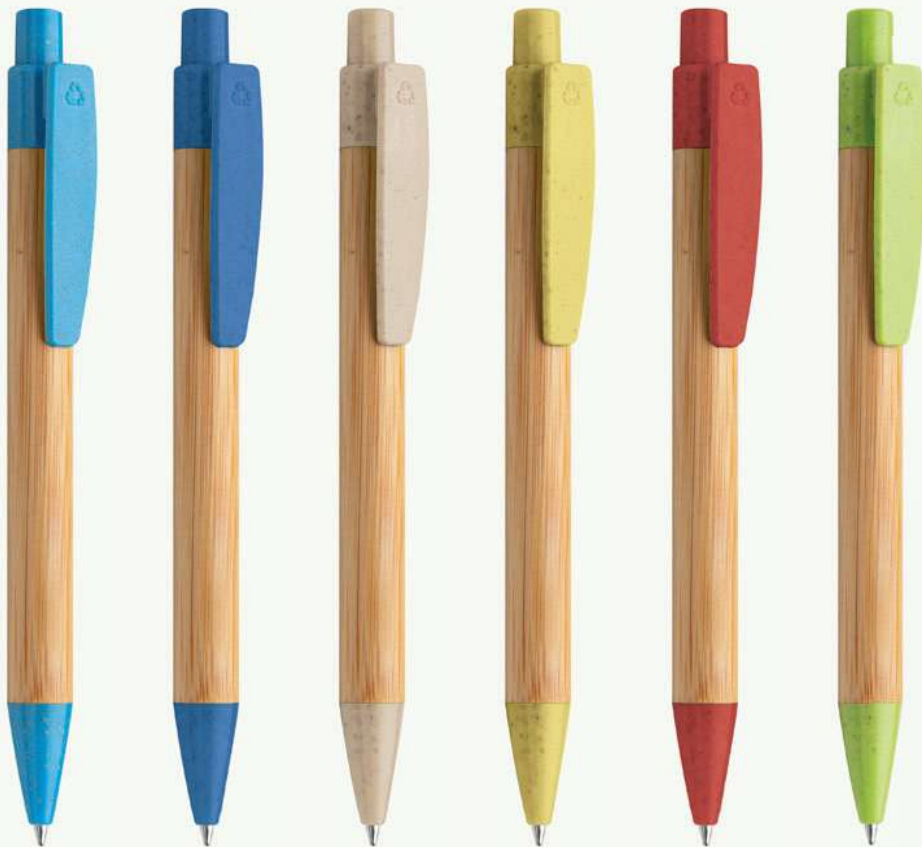

AZ

BL

EC

GI

RO

VE

**PD525 CROWN**

penna in bamboo, refill nero  
minuterie in paglia di frumento



☐ Ø 1,05xh14 cm ca  
📦 100/1000 🌐 SE TA UV



PAGLIA DI FRUMENTO  
E BAMBOO

**NEW!**







## SUSTAINABLE SELECTION

Astuccio in carta con penna e portamine in bamboo.

### PD497 BAMBOO SET

set penna + portamine in bamboo  
portamine automatica  
minuterie in metallo cromato  
refill nero, astuccio in carta



-  penna: Ø 1,1xh14 cm ca
-  micromina: Ø 1,1xh14 cm ca
-  astuccio: 17x4x2,2 cm ca
-  25/300  IN SE TA UV



BI

BL

GR



RO

VE

### PD499 BAMBOO RING

penna in bamboo, rifiniture gommate  
minuterie in metallo, refill nero



-  Ø 1,1x14 cm ca
-  50/1000  IN SE TA UV









## SUSTAINABLE SELECTION

Astuccio in carta effetto legno con penna e portamine in bamboo.

### PD501 BAMBOO SET TOUCH

set penna + portamine in bamboo  
micromina automatica  
gommino touch, refill nero  
minuterie in metallo cromato  
astuccio in carta effetto legno



-  penna: Ø 1,1xh14 cm ca
-  micromina: Ø 1,1xh14 cm ca
-  astuccio: 17x4x2,2 cm ca
-  25/300  IN SE TA UV





gommino touch



### PD462 B-RING

penna in bamboo  
minuterie in metallo  
refill nero





-  Ø 1,05x14 cm ca
-  50/500
-  IN SE TA UV



### PD503 BAMBOO

penna in bamboo  
minuterie in metallo  
refill nero





-  Ø 1,1x14 cm ca
-  50/1000
-  IN SE TA UV



### PD504 B-TOUCH

penna in bamboo  
minuterie in metallo  
gommino touch  
refill nero



-  Ø 1,1x14 cm ca
-  50/1000
-  IN SE TA UV



gommino touch



**PD505 BAMBOO STAND**

penna in bamboo,  
supporto per smartpone  
gommino touch, refill nero



☐ Ø 1,1xh14,5 cm ca  
📦 50/1000 🌐 SE TA UV IN



BAMBOO



TOUCH  
SCREEN



GREEN

Supporto per  
smartphone



gommino  
touch



BI

BL

RO

VE

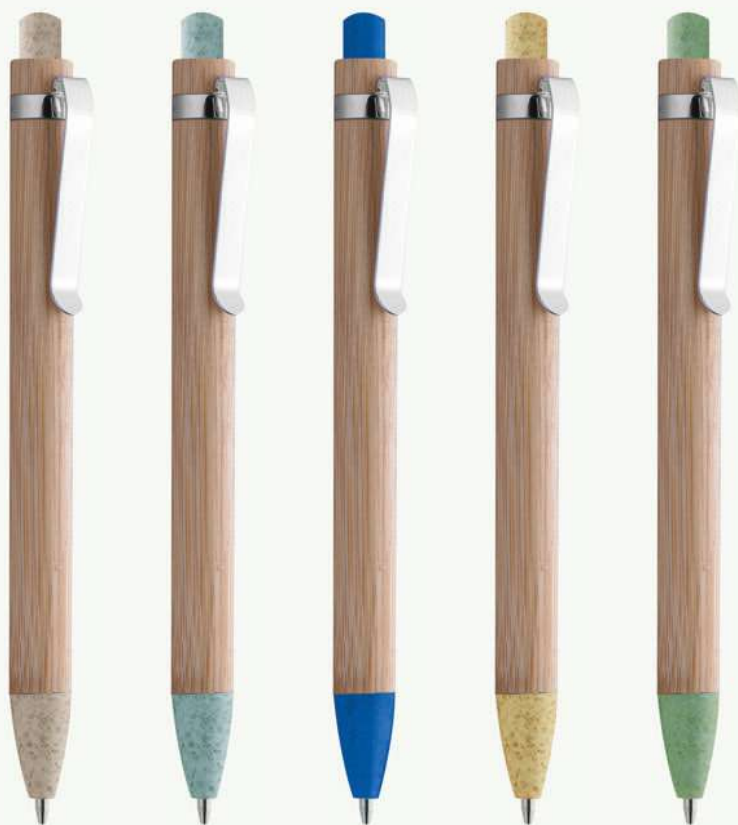

EC

AZ

BL

GI

VE

**PD521 BAMBOO WHEAT**

penna in bamboo, minuterie in paglia  
di frumento, refill nero



☐ Ø 1,1xh14 cm ca  
📦 50/1000 🌐 IN SE TA UV



BAMBOO



GREEN



**PD519** TIMBER

penna in bamboo e plastica  
minuterie e clip in colore silver  
refill nero



☐ Ø 1,05xh14 cm ca  
📦 100/1000 🏠 SE TA UV



BAMBOO



GREEN

**PD527** LUMBER

penna in bamboo  
minuterie in metallo cromato  
refill nero



☐ Ø 1,05xh14 cm ca  
📦 100/1000 🏠 SE TA UV



BAMBOO



GREEN

**PD524** B-STYLUS

penna in bamboo, refill nero  
minuterie in metallo cromato  
gommino per touch screen



☐ Ø 1,05xh14 cm ca  
📦 100/1000 🏠 SE TA UV



BAMBOO



GREEN

TOUCH  
SCREEN

BI



BL



NE



RO



VE

**PD523 BAMBOO TWIST**

penna in bamboo  
minuterie in metallo, clip silver  
refill nero



∅ 1,05xh14 cm ca  
100/1000 SE TA UV



BAMBOO



GREEN



**PD529 CORK TWIST**

penna in sughero e metallo  
minuterie in metallo, clip silver  
refill nero



∅ 1,05xh14 cm ca  
100/1000 SE TA UV



SUGHERO



GREEN



**PD522 SENZA FINE**

matita inesauribile, fusto in bamboo  
tappo in materiale rigido, refill nero



∅ 0,8xh13,7 cm ca  
50/1000 SE TA UV



BAMBOO



GREEN



LA MATITA ECOLOGICA  
INESAURIBILE SCRITTURA  
SENZA FINE



**PD511 CAPPUCCINO**

penna corpo in carta, refill nero  
minuterie: 50% caffè - 50% ABS



∅ 1x14 cm ca  
100/1000 SE TA UV



COFFEE PEN

Penne realizzate con fondi di caffè.



GREEN

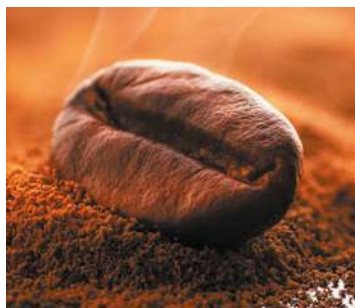

**PD518 OCEAN**

penna in RPET, fusto colorato, refill nero



- ☑ Ø 1xh13,7 cm ca
- ☑ 50/1000 ☑ SE TA UV

## RPET ZERO SPRECHI



Penne in plastica riciclata



AR

AZ

BI

BL

VE

**PD022 CORK SET**

set penne con corpo in sughero  
minuterie in metallo, refill nero  
penna a sfera con meccanismo a rotazione  
penna roller con tappo in metallo  
astuccio in sughero



- ☑ astuccio: 16x6xh3 cm ca
- ☑ penne: Ø 1xh13 cm ca
- ☑ 10/200 ☑ SE TA UV



NEW!



**2 PENNE:**  
PENNA A SFERA  
E ROLLER







 PAGLIA DI FRUMENTO  
CARTA E LEGNO

### PD583 WOODEN SET

set da scrittura ecologico coposto da:  
penna in carta e paglia di frumento  
matita in legno, temperamatite in le-  
gno, righello in legno cm 15  
gomma bianca, astuccio in carta con  
elastico



-  matita:  
Ø 0,7xh17,5 cm ca
-  penna:  
Ø 1xh14 cm ca
-  astuccio: 17x4 cm ca
-  10/200  IN SE TA UV



### SET DA DISEGNO





astuccio cilindrico  
in cartone  
chiusura in plastica  
con temperamatite



### PD530 DONATELLO

set 12 mini pastelli in legno pretemperati







-  pastello: Ø 0,75xh6,5 cm ca
-  astuccio: Ø 3,5xh10 cm ca
-  20/200  TA UV



### PD532 CANVAS

set 7 mini pastelli in legno pretemperati



-  pastello: Ø 0,75xh6,5 cm ca
-  astuccio: Ø 2,5xh10 cm ca
-  50/400  TA UV



**PD540 LEONARDO**

set 12 mini pastelli in legno, pretemperati  
astuccio in cartoncino naturale



- ☑ pastello: Ø 0,75xh9 cm ca
- ☑ astuccio: 8,8xh9x0,8 cm ca
- 📦 25/250 📦 SE TA UV

**PD545 MICHELANGELO**

set 6 mini pastelli in legno, pretemperati  
astuccio in cartoncino naturale



- ☑ pastello: Ø 0,75xh9 cm ca
- ☑ astuccio: 4,5xh9x0,8 cm ca
- 📦 25/500 📦 SE TA UV

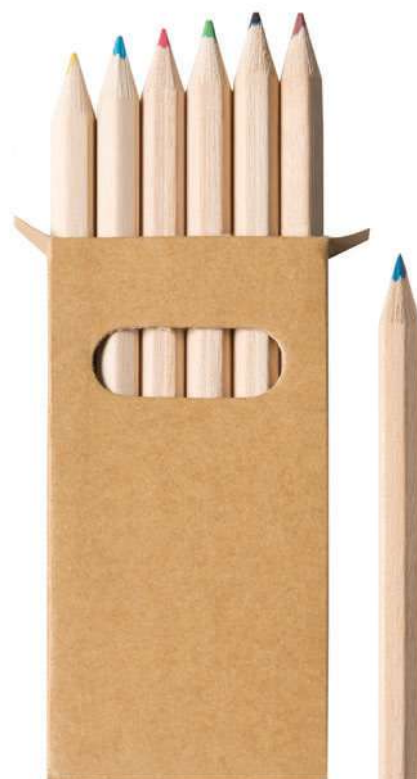

**PD536 PABLO**

set 12 mini pastelli pretemperati, 12 disegni da colorare carta 80 g



pastello: Ø 0,75x9 cm ca    astuccio: 9x9x1 cm ca  
 25/200    SE TA UV



**Blocco  
 incluso**  
 con 12  
 disegni da  
 colorare

**PD548 RAINBOW FOUR**matita fusto piatto in legno  
punta a 4 colori  
fornita temperata

Ø 1x17 cm ca  
 72/1440    SE TA UV

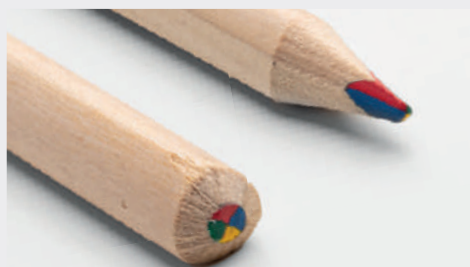
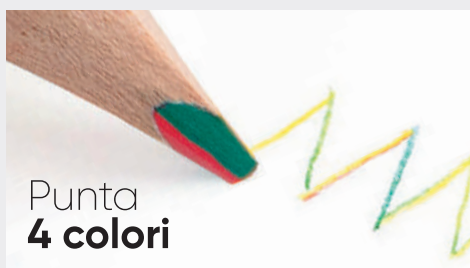
**NEW!****PD572 NEWSPAPER**matita con fusto in carta di giornale  
fornita temperata

Ø 0,6x17 cm ca  
 100/2000    SE TA UV

**NEW!**

Realizzata in  
**carta di giornale**





# Sprouts

**NEW!**

matite piantabili in legno sostenibile, mina in grafite capsula con semi, fornite temperate

☐ 0,8xh19 cm ca ☐ 100/500 ☐ SE TA UV



Quando la matita sarà corta per essere usata, potrai piantarla immergendo solo la capsula verde nel terriccio inclinando la matita di circa 30 gradi



Le prime settimane annaffiare spesso (mantenendo il terriccio umido). Mantenere la pianta in un luogo luminoso evitando la luce diretta del sole



A seconda della pianta le matite germoglieranno in 1-4 settimane

**NEW!**

**PD562**  
BASILICO

**NEW!**

**PD565**  
MARGHERITA

**NEW!**

**PD566**  
GIRASOLE

**NEW!**

**PD568**  
POMODORO

**NEW!**

**PD569**  
GAROFANO



**PD575 FIONA**

matita in legno pretemperata  
gommino colorato



☐ Ø 0,7xh19 cm ca  
📦 100/1000 🔄 SE TA UV



AR AZ BI BL GI NE RO VE

**PD570 VALENTINA**

matita in legno laccato  
gommino bianco  
pretemperata



☐ Ø 0,7xh19 cm ca  
📦 100/1000 🔄 SE TA UV



AZ BI BL CL NE OR RO SI VE



**PD563 BLACKWOOD**

matita in legno laccato  
gommino colorato  
pretemperata



☑ Ø 0,7x19 cm ca  
📦 100/1000 📦 SE TA UV

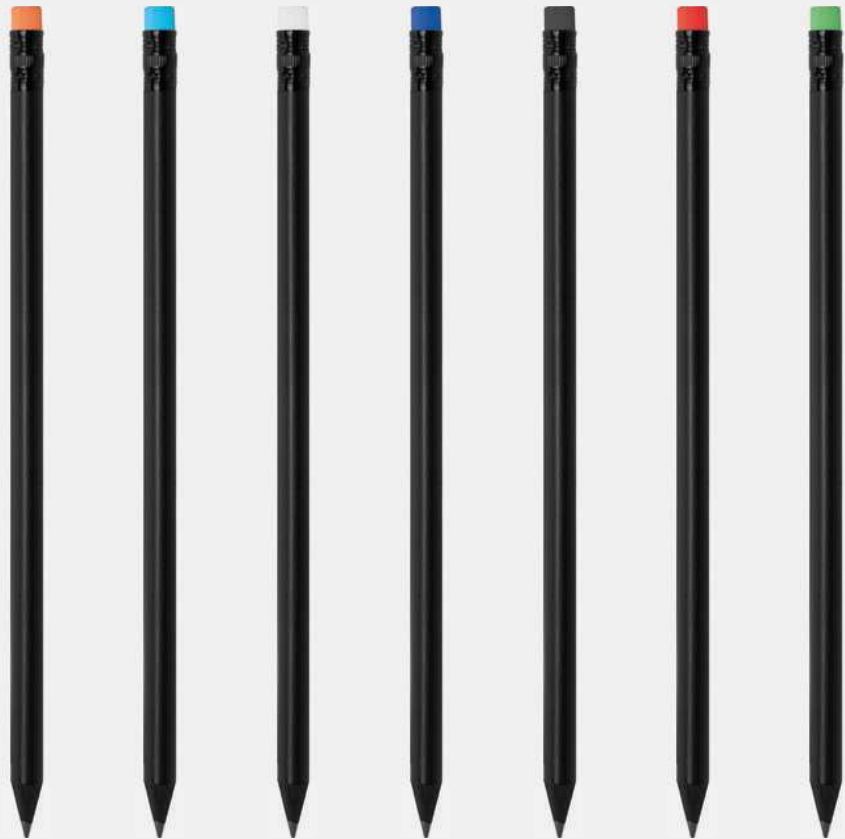

AR

AZ

BI

BL

NE

RO

VE

**PD582 COMPLETE NAT**

set da scrittura composto da:  
3 matite pretemperate  
gomma, righello 16 cm  
temperamatite in legno  
astuccio in cartoncino naturale



☑ matita: Ø 0,6x17,5 cm ca  
☑ astuccio: 4,5x18x1,5 cm ca  
📦 20/240 📦 SE TA UV

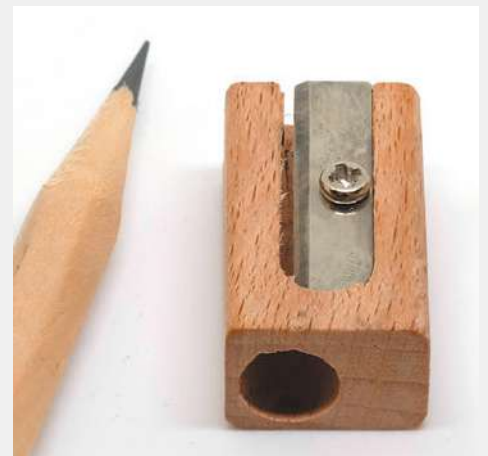

# 02.

## UFFICIO E LAVORO



**PH204** MONTRY DUE TONI

borsa porta PC imbottita in poliesteri 300D effetto melange, tasca frontale con velcro tracolla regolabile e manici



38x32x4 cm ca

1/36 SE TR



tasca frontale con velcro

**PH222** QUOTA DUE TONI

borsa p/documenti in poliesteri 300D effetto melange, tracolla regolabile manico, interno multitasche, tasca esterna con cerniera



40x30x8 cm ca

1/50 SE TR



interno imbottito porta pc



## CARTELLA PORTA DOCUMENTI

Borsa ventiquattrore in ecopelle solida e resistente. Ideale per documenti voluminosi, pc o Ipad.



### PH106 PRESTIGE

cartella in ecopelle, chiusura in metallo  
interno multitasche con cerniera  
tasca sul retro, tasca interna imbottita porta pc  
tracolla regolabile con salvaspalle, astuccio



43x32x14 cm ca

1/6 SE

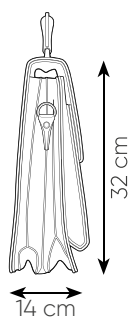
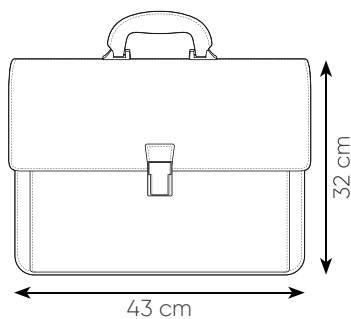



2 tasche esterne

**CA047 THINY**

borsa bicolore in poliuretano  
manico integrato, 2 tasche interne  
2 tasche esterne



35x37 cm ca  
1/20 CA IN SE

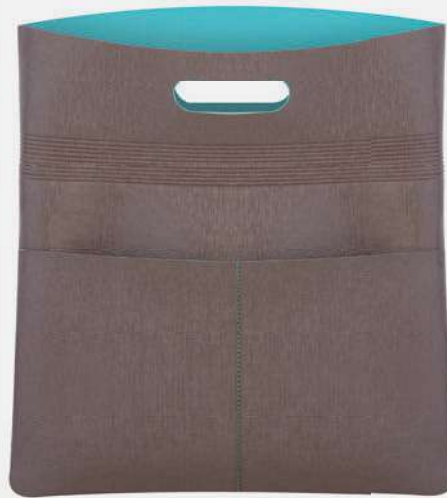

MC



AR



BL



RA

**CA067 POCLETTE**

borsello pochette/portadocumenti  
poliuretano, astuccio Cavallari Studio  
bicolore con interno a contrasto  
chiusura con bottoni a pressione



33x24 cm ca  
1/25 CA IN SE



struttura apribile  
interamente



BC



BO



GR



MC



MR



NR

**CAVALLARI STUDIO**



BC



TRACOLLA  
BUSINESS  
PORTA PC

RY



AR

**PH205** MONTRY

borsa in poliestere 600D  
tracolla regolabile  
interno imbottito porta pc



38xh32x4 cm ca  
1/36 SE TR



GR



RO

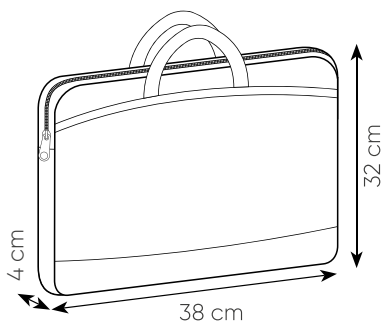

interno  
imbottito  
porta pc  
e porta  
tablet



## TRACCOLLA BUSINESS PORTA DOCUMENTI



NG

### PH234 VALLEY

borsa p/documenti in poliestere 600D, interno multitasche, tracolla regolabile



39,5xh29x8 cm ca

1/30 SE TR



BL



BR



GR



NE



VE

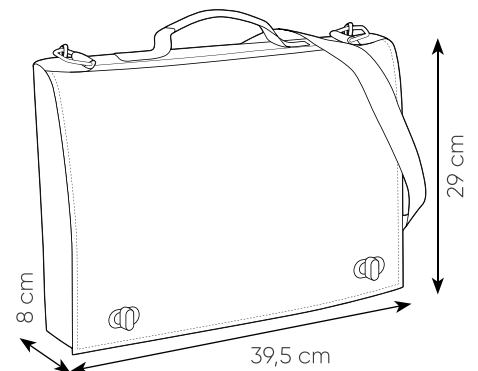



Interno multitasche:  
portapenne  
portacard

## PH224 QUOTA

borsa p/documenti in poliester 600D  
tracolla regolabile, manico  
interno multitasche, tasca esterna con cerniera



40xh30x8 cm ca

1/50 SE TR



RO

## PH225 AENEAS

borsa p/documenti in poliester 600D  
interno multitasche, tracolla regolabile  
tasca esterna con zip



40xh32x11 cm ca

1/20 SE TR



BL

GR



**PH240 EATON**

borsa p/documenti in tnt  
 doppia chiusura con velcro  
 tracolla personalizzabile  
 1 scomparto  
 tasche interne portapenne



36x27x7,5 cm ca  
 10/100 SE

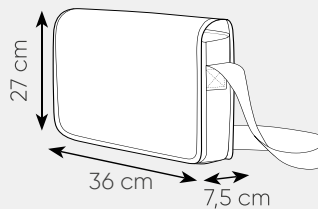

BL

tasche interne portapenne



BY



GR



RO



RY

**PH252 DOX**

borsa p/documenti  
 poliestere 600D  
 chiusura con zip



41x31 cm ca  
 10/100 SE TR



BI



GR



NE



RO



RY



BL



### PH292 CONSEJO

cartella sottobraccio  
 poliuretano termovirante  
 blocco per appunti  
 chiusura con cerniera, astuccio



35x28 cm ca  
 1/10 CA IN SE UV



supporto per iPad e Tablet



ampia tasca interna laterale



BL

manici magnetici per uso borsa a mano



cartella multitasche con blocco per appunti



NE



MA

### PH300 BRUXELLES

cartella sottobraccio in ecopelle  
 chiusura con cerniera  
 interno multitasche  
 blocco per appunti  
 calcolatrice, astuccio



25,5xh34x2,5 cm ca  
 1/10 SE UV

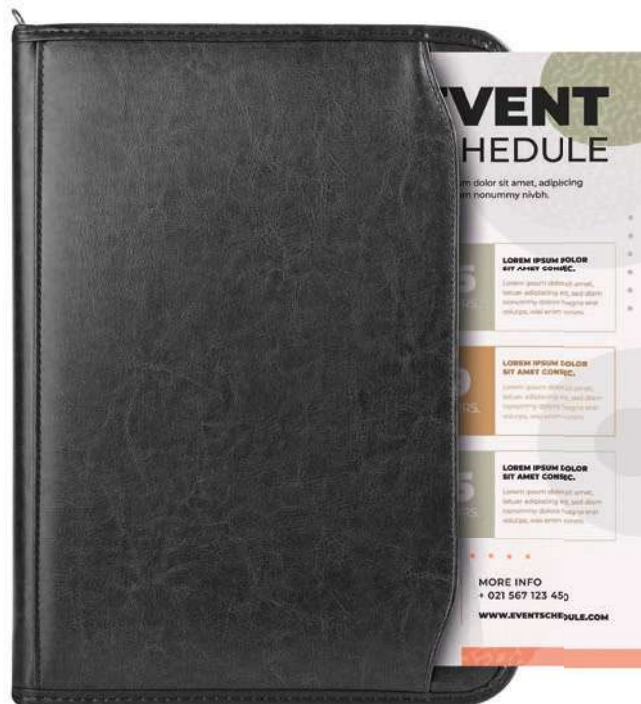
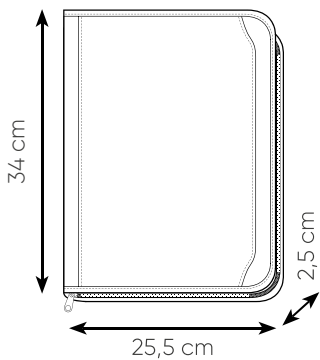

NE

ampia tasca frontale  
 porta documenti

# CARTELLE SOTTOBRACCIO

poliestere 600D  
blocco per appunti  
chiusura con cerniera



BL

NE

## PH311 PORTFOLIO RING

interno multitasca con anelli



25x34,5x4,5 cm ca

1/20 SE TR

## PH315 PORTFOLIO

interno multitasca



25x34,5x3,5 cm ca

1/20 SE TR



**PH311 PORTFOLIO RING:** interno con anelli



**PH315 PORTFOLIO:** interno senza anelli



# ZERO SPRECHI



Cartella in cartone riciclato con blocco note e penna



## PH636 CARTON FOLD

cartella rigida in cartone riciclato  
tasche interne, penna inclusa  
blocco note removibile da 20 fogli



23,5x32x1,5 cm ca

1/50 SE UV





NE

BL

### PH450 BOARD

cartellina portablocco PVC rigido  
tasca interna in PVC trasparente



23x32 cm ca  
20/60 SE UV



NE

BL

### PH455 CONVENTION

cartellina portablocco  
PVC elettrosaldato  
interno multitasche



23x32,5 cm ca  
1/25 SE UV





## BLOCCHI A4 COMPATIBILI CON PH450 E PH455



### PA840 BLOCK LINE

blocco 50 fogli a righe  
formato A4



- ☑ 21x29,8 cm ca
- ☑ testata:21x3 cm ca
- 📦 25

### PA842 BLOCK SQUARE

blocco 50 fogli a quadretti  
formato A4



- ☑ 21x29,8 cm ca
- ☑ testata:21x3 cm ca
- 📦 25

### PA844 BLOCK MILLY

blocco 50 fogli a quadrettini  
formato A4



- ☑ 21x29,8 cm ca
- ☑ testata:21x3 cm ca
- 📦 25

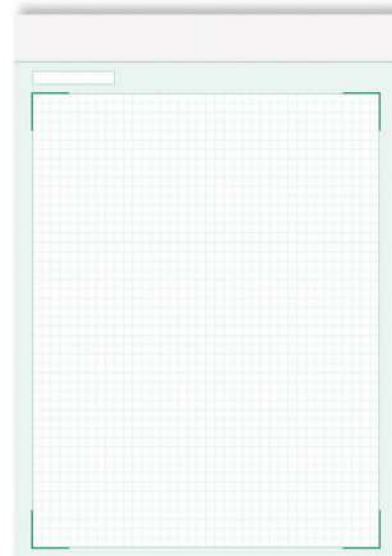

### PH480 PAPEL

portacard in poliuretano  
capienza 12 cards



7,2xh10,2 cm ca

50/500

CA IN SE TA UV



BL



AR



AZ



GI



NE



RO



VL

**PH482 SAVE CARD 7**

portacard in alluminio, capienza 7 cards, protezione RFID

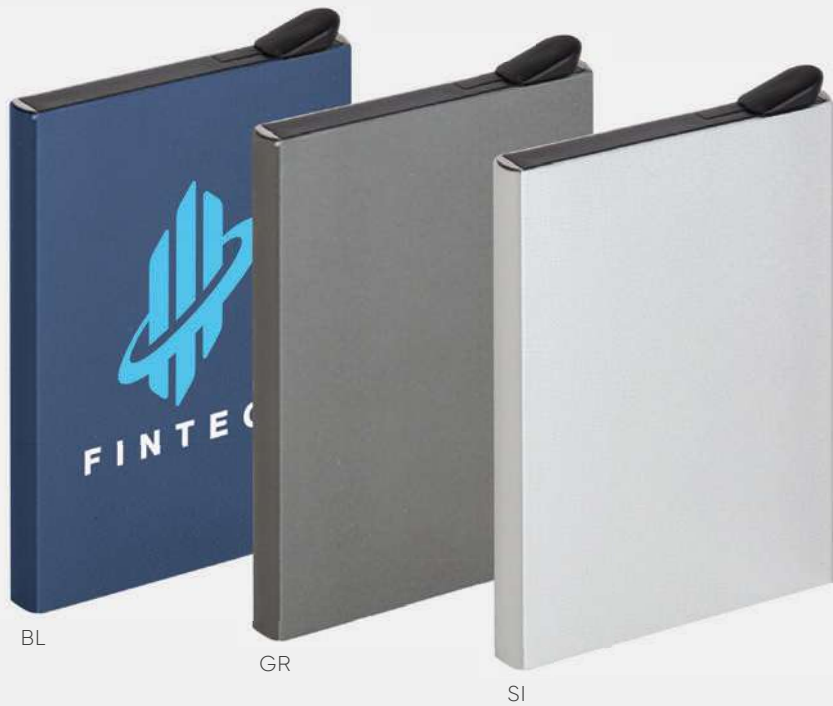

6,2xh9,5x0,8 cm ca  
50/200 SE TA UV

**PH485 TILE**

portacard capienza 7 cards, BI e NE in plastica, SI in metallo



11xh7,5 cm ca  
50/200 SE TA UV



# PORTACARD RFID



portacard in tam  
protezione RFID  
interno bicolore



## PN268 BANKOMAT

10 tasche



7,5x10,3 cm ca  
25/350 SE UV



AR



BL



NE



RO



VL



## PN269 BASIC CARD

2 tasche



5,5x9,5 cm ca  
50/800 SE UV



AR



AZ



BL



NE



VL



RO

**PN264 WHEAT CARD**

porta card in paglia di frumento, protezione RFID



9x6x0,5 cm ca

100/1000 SE TA UV

NEW!



PAGLIA DI FRUMENTO

**PH491 DOLLAR**

fermasoldi magnetico in ecopelle angoli in metallo, astuccio



6x3 cm ca

50/200 SE TA UV



BL



MA

**PF411 SAVE CARD 8**

portacarte in poliuretano 8 posti, protezione RFID



8,2x11,7 cm ca

1/200 CA IN SE TA UV

PORTACARD  
RFID

# BUSTE PER DOCUMENTI



RO

## PH502 MICRI

busta portadocumenti in pvc, tasca esterna porta tessera, chiusura con bottone nero



📏 21,7xh15,7 cm ca  
📦 20/600 📏 SE



BI



BL



RY



VE



RY

## PH504 SCATH

busta portadocumenti in pvc chiusura con bottone



📏 21xh15 cm ca  
📦 20/600 📏 SE



TR

**PH507 MINI FLIP**

busta portadocumenti in pp  
chiusura con bottone



24x17 cm ca  
20/600 SE



adatta per  
documenti fino  
al **formato A5**  
(fogli non piegati)

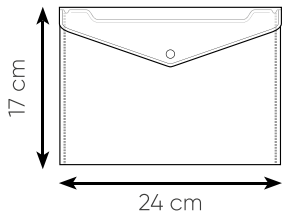

PH507VE

**PH510 FLIP**

busta portadocumenti in pp  
chiusura con bottone



32x23 cm ca  
12/480 SE

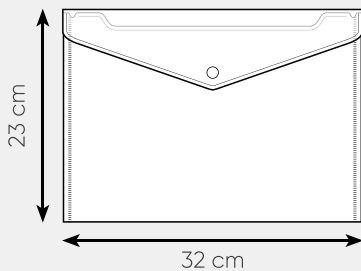

adatta per  
documenti fino  
al **formato A4**  
(fogli non piegati)



PH510RY

**COLORI DISPONIBILI:**

GI



RY

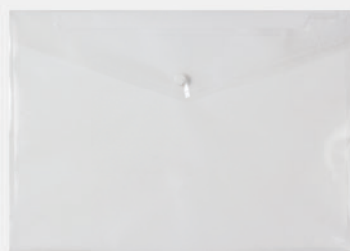

TR



VE

**PH523 IDENTITY**

portabadge in plastica trasparente  
nastrino, clip nichelata



9x6,7 cm ca  
100/1000 SE

**PH530 PASS**

portabadge in pvc trasparente  
clip nichelata, cartoncino

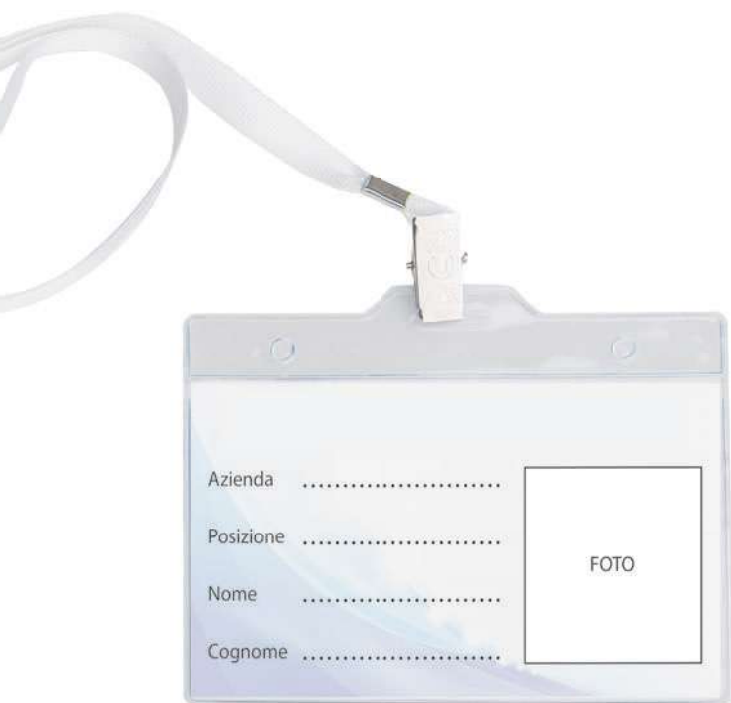

9,5x8 cm ca  
100/1000 SE

**PH544 CONFERENCE**

portabadge in pvc trasparente  
nastrino, clip nichelata, cartoncino

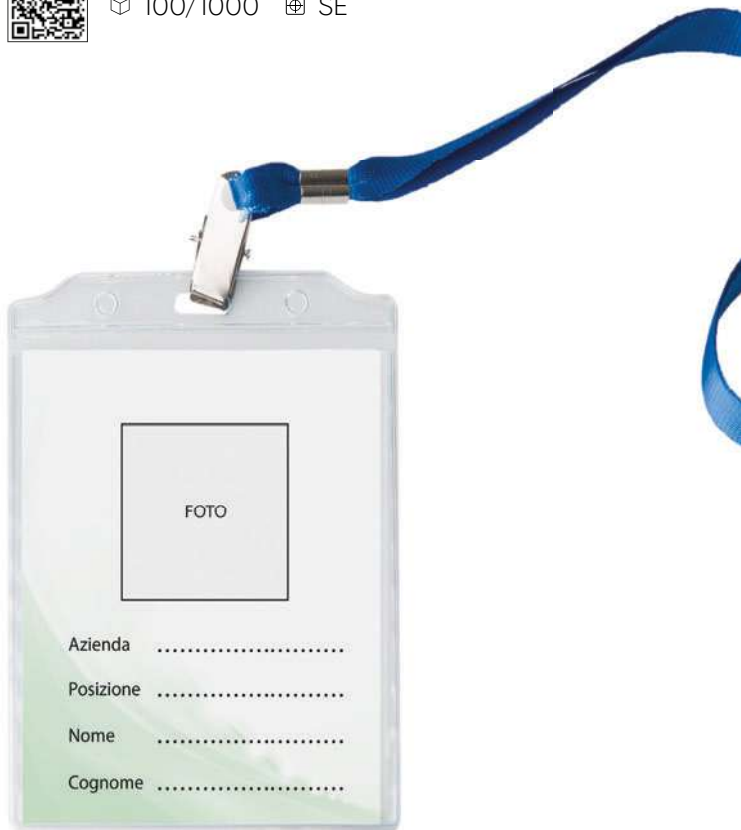

12x9,2 cm ca  
100/1000 SE

**PH545 NAME**

portabadge in pvc trasparente  
nastrino, clip nichelata, cartoncino



9,3x12,5 cm ca  
100/1000 SE



## LANYARD PORTA BADGE

ampia gamma di lanyard colorati, resistenti e versatili. Perfetti per agganciare badge, tesserini identificativi o chiavi.



### PJ504 LACE

cordoncino da collo in poliestere, gancio in metallo portabadge, portachiavi



2x82 cm ca

10/500 SE SU (BI-WG)



AR

AZ

BI

BL

FX

GI



IT

NE

RS

RY

VE

WG



## SPECIALE SUBLIMAZIONE

I colori **BI** e **WG** permettono la personalizzazione tramite la stampa sublimatica.



## PJ506 SAFETY

cordoncino da collo in poliestere  
portabadge  
gancio in metallo  
portachiavi  
dispositivo di sicurezza



2x78 cm ca  
10/500 SE SU (BI)





### PJ560 ALL IN

borsellino collier multiuso  
poliestere 210D  
chiusura con cerniera  
occhiello in metallo  
laccio con gancio  
cartoncino non incluso



12x20 cm ca

10/200 SE SU (BI)



BI



BL



### PJ505 BLANCO

cordoncino da collo RPET, portachiavi  
portabadge, gancio in metallo cromato



2x50 cm ca

10/500 SE SU



**SPECIALE  
SUBLIMAZIONE**

La particolare superficie di questo lanyard permette la personalizzazione tramite la stampa sublimatica.





**PF345 PEN BOX**

portapenne usb in plastica  
4 luci led in 2 posizioni, 4 porte usb 2.0



- ☐ 7x8x7 cm ca
- 📦 1/100    🏠 SE TA UV



**PH547 PATTY**

portapenne da scrivania in plastica



- ☐ 5,5x13,5x6 cm ca
- 📦 72/72    🏠 SE TA



**PH550 BASKET**

portapenne da scrivania in plastica



- ☐ 6,5x8,5x6,5 cm ca
- 📦 198/198    🏠 SE TA UV



## PORTAPENNE MULTIFUNZIONE

display digitale con:  
orario, data e temperatura  
pulsanti posteriori  
confezionati in scatola

### PH551 BAMBOO HOLDER

portapenne in bamboo



7,5x7,5x9,5 cm ca  
1/50 IN SE TA

### PH553 CORK HOLDER

portapenne in sughero



7,5x7,5x9,5 cm ca  
1/50 SE IN UV



BAMBOO



SUGHERO

personalizzabili anche  
su retro e laterali

### PH555 PERPETUO

calendario perpetuo in bamboo, base a supporto, 4 cubi incisi  
sigle, giorni e mesi, astuccio incluso



base: 14x5x2 cm ca cubo: 3x3x3 cm ca  
1/100 IN SE TA



BAMBOO



quattro cubi incisi  
per comporre la data

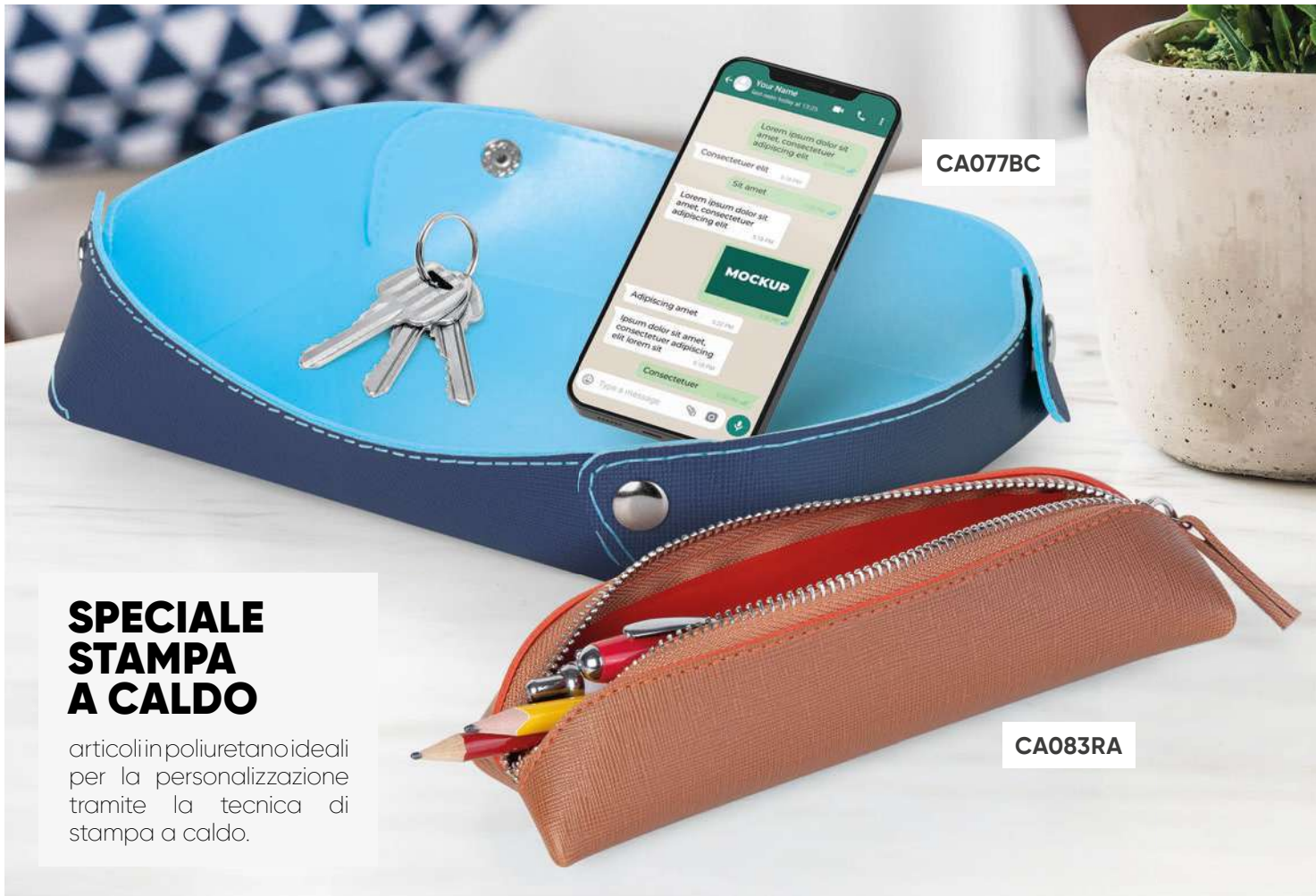

**SPECIALE  
STAMPA  
A CALDO**

articoli in poliuretano ideali per la personalizzazione tramite la tecnica di stampa a caldo.

**CA077 COMFORT**

svuotatasche bicolore in poliuretano chiusura con bottoni a pressione corredato di astuccio



- 📏 aperto: 17,5x22,5 cm ca
- 📏 chiuso: 15,5x11 cm ca
- 📦 1/50 🏠 CA IN SE



struttura apribile per una stampa facile



MA



RC



RS



VA

**CA083 PENHOLDER**

astuccio penne in poliuretano bicolore, chiusura con zip corredato di astuccio



- 📏 18,5x6,5 cm ca
- 📦 1/100 🏠 CA IN SE

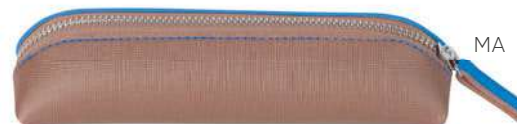

MA



RC

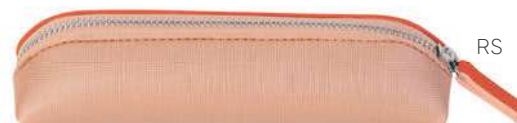

RS



## POLIURETANO TERMОВIRANTE

svuotatasche in poliuretano termovirante. ideale per la personalizzazione tramite la tecnica di stampa a caldo.

### PH701 RESTO

svuotatasche in poliuretano termovirante  
chiusura con bottoni a scomparsa



- 📏 chiuso: 19x19 cm ca
- 📏 aperto: 22x22 cm ca
- 📦 20/240 📦 CA IN SE UV



### PH585 SHINY

portacarte da scrivania in similpelle  
 contenitore in plastica, blocco per appunti  
 3 blocchi segnapagina, astuccio, calendario



17,5xh3x9 cm ca  
 25/50 SE UV



### PH590 BRILLIANT

portacarte da scrivania in similpelle  
 contenitore in plastica, calendario  
 blocco per appunti in carta bianca, astuccio



9,5xh3x9 cm ca  
 50/100 SE UV

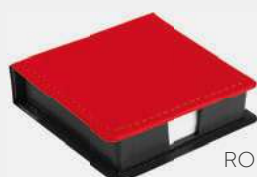



SUSTAINABLE  
SELECTION

Articoli realizzati in  
materiali sostenibili:  
carta naturale, bamboo.



## PH598 MAPLE

set appunti in carta naturale, righello in pvc, 2 blocchi fogli adesivi  
5 blocchi segnapagina, penna a sfera inchiostro nero, righello



- ☑ 16xh2x6 cm ca
- 📦 50/100 🌐 SE UV



## PH593 MINI KIT

set da scrivania in carta  
foglietti adesivi, segnapagina colorati  
blocco di carta con fogli colorati



- ☑ chiuso: 9xh9x9 cm ca
- ☑ aperto: 19,5xh9x9 cm ca
- 📦 18/36 🌐 SE UV



NE



BI



struttura  
richiudibile  
a cubo

SUSTAINABLE  
SELECTION

AV









SUSTAINABLE  
SELECTION 

### PH606 NOTES BOX CUBE

set da scrivania in carta, blocco di carta portapenne e fogli  
5 blocchi segnapagina colorati adesivi



-  chiuso: 10,5x10,5 cm ca
-  aperto: 41,5x10,5 cm ca
-  12/24  SE UV

struttura  
richiudibile  
in box





SUSTAINABLE  
SELECTION

### PH615 NOTES WRITE SET

set notes, blocco per appunti, 1 blocco di fogli adesivi, righello in pvc, 5 blocchi segnapagina colorati adesivi  
penna a sfera inchiostro nero, 2 matite, 1 temperamatite in legno, 1 gomma per cancellare, 1 righello 15 cm in legno



-  15x21x2,3 cm ca
-  20/40  SE UV

**PH633 NOTES SET BAMBOO**

set appunti da scrivania in  
bamboo, carta e plastica  
due blocchi in carta riciclata  
tre blocchi segnapagina



- ☑ set: 12x10,5x2 cm ca
- ☑ blocco note 1: 6,5x9,5 cm ca
- ☑ blocco note 2: 4x5 cm ca
- 📦 1/60 🌱 IN SE UV



fori per scelta del  
colore dei blocchi  
segnapagina



SUSTAINABLE  
SELECTION

**PH616 NOTES BAMBOO**

notes e penna in bamboo  
spirale, 160 pagine a righe



- ☑ 17xh21,5 cm ca
- 📦 1/50 🌱 IN SE UV

SUSTAINABLE  
SELECTION



BAMBOO



160 pagine a righe  
corredata di penna



### PB577 PARURE BAMBOO

notes con spirale in bamboo e carta  
160 pagine a righe, penna in bamboo



- 📏 notes: 14,5x21 cm ca
- 📏 astuccio: 22,5x21,5x2 cm ca
- 📦 1/40 🌱 IN SE UV



Penna in bamboo  
e minuterie in metallo



160 pagine a righe con spirale

**PH617** SPIRAL BAMBOO

notes e penna in bamboo con spirale  
140 pagine a righe



10x15 cm ca  
1/100 IN SE UV



BAMBOO



SUSTAINABLE  
SELECTION 

**PH618** MINI NOTES BAMBOO

notes in bamboo con spirale  
160 pagine a righe



9x12 cm ca  
1/100 IN SE UV



BAMBOO



SUSTAINABLE  
SELECTION 

SUSTAINABLE  
SELECTION

Notes realizzato in  
materiali ecologici:  
cotone canvas e  
bambù

NEW!

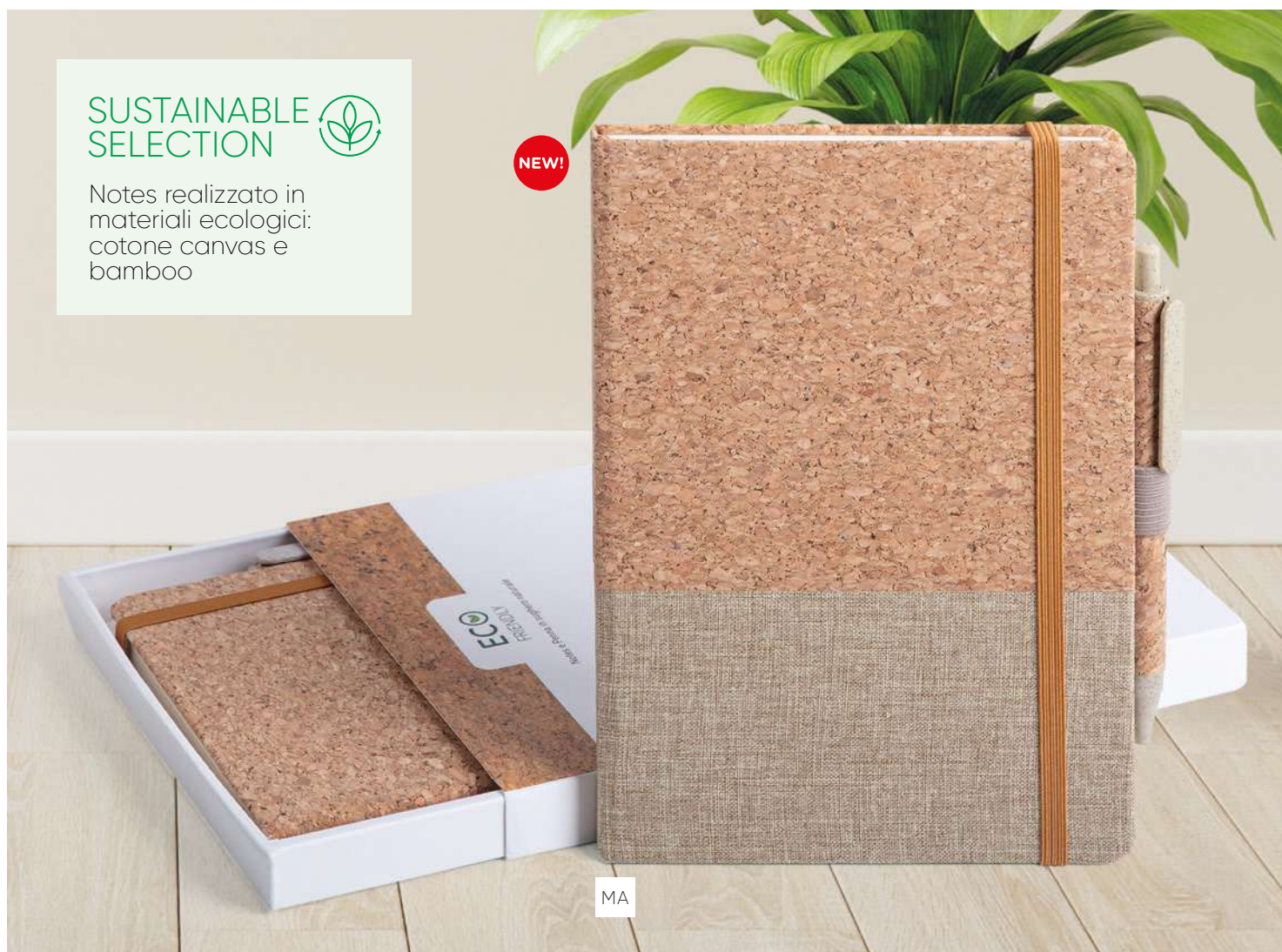

MA

**PB569** PARURE CANVAS

notes con elastico in cotone canvas e sughero, 160 pagine avorio a righe  
segnapagina e portapenne in tinta, quadranti con angoli tondi  
chiusura con elastico, corredata di penna



- notes: 14x21 cm ca
- astuccio: 17,3x22,3 cm ca
- 30  SE IN UV

160 pagine a righe  
carta avorio



EC



## NOTES IN SUGHERO

160 pagine a righe carta avorio  
segnapagina ed elastico in tinta  
quadranti ad angoli tondi  
chiusura con elastico, portapenne

### PB575 NOTES CORK BIG



📏 14x21 cm ca  
📦 20/40 🌱 SE IN UV

### PB576 NOTES CORK



📏 9x14 cm ca  
📦 20/80 🌱 SE UV

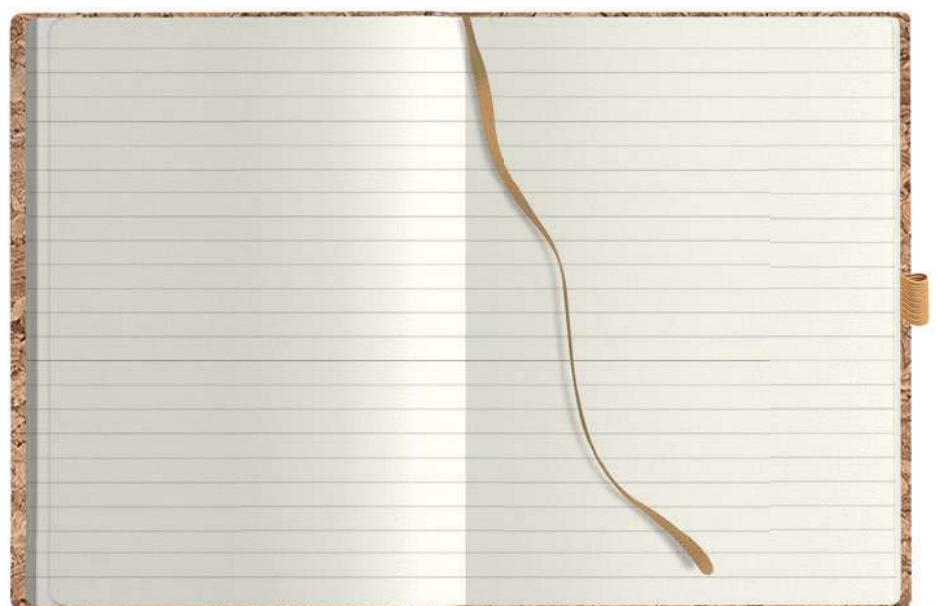

160 pagine a righe carta avorio

**PB583 NOTES PENDANT**

notes con spirale in carta riciclata  
 interno 160 pagine a righe  
 elastico in tinta



14,5x21 cm ca  
 20/40 SE UV

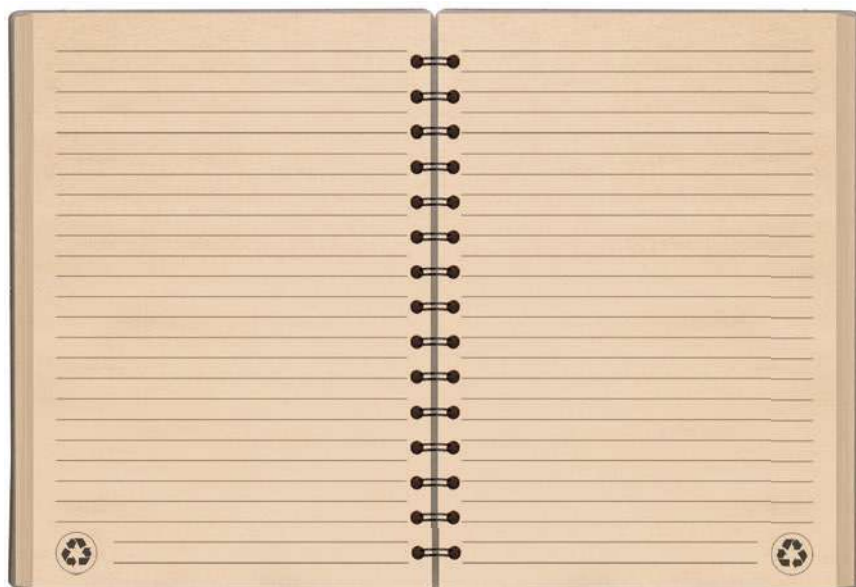

160 pagine a righe con spirale



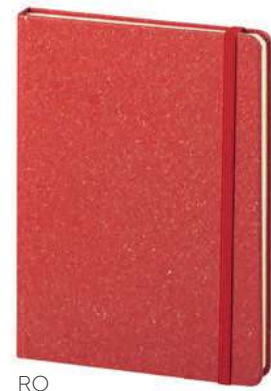

### PB587 NOTES THERMO PAPER

notes in carta termocristallina, interno 160 pagine a righe carta avorio, elastico in tinta, quadranti ad angoli tondi, astuccio su richiesta PB598



14x21 cm ca  
1/40 SE UV



carta termocristallina



160 pagine a righe con spirale



## NOTES IN CARTA RICICLATA

160 pagine a righe, elastico colorato

### PB588 NOTES



📏 15x21 cm ca  
📦 20/40 🌐 SE UV

colori disponibili: VE EC

### PB611 NOTES TASCABILE



📏 9x14 cm ca  
📦 20/80 🌐 SE UV

colori disponibili: VE EC

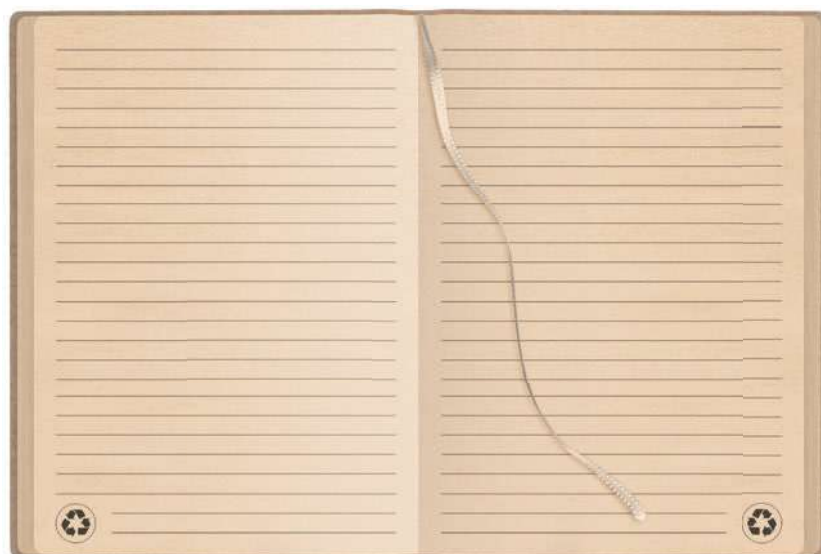

160 pagine a righe



## NOTES IN CARTA KRAFT

160 pagine a righe carta avorio  
segnapagina ed elastico colorato  
quadranti ad angoli tondi

### PB589 NOTES



14x21 cm ca  
20/40 SE UV

### PB603 NOTES TASCABILE



9x14 cm ca  
20/80 SE UV

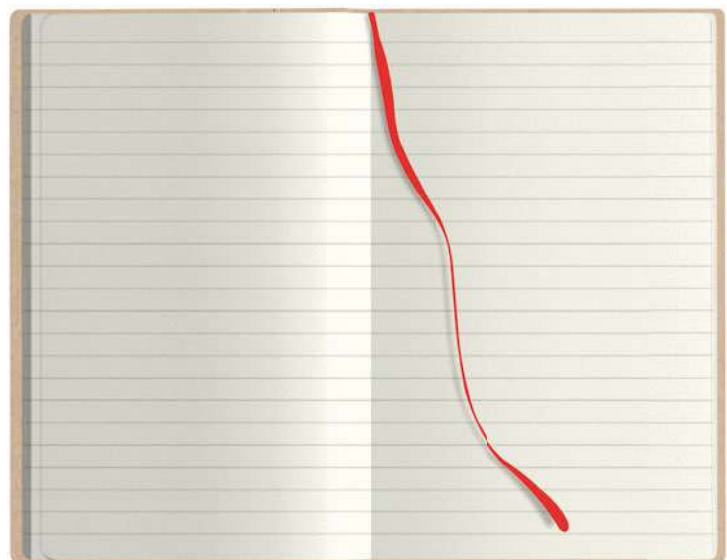

160 pagine a righe

# TERMОВИRANTE

NEW!



- BL
- AZ
- VE
- NE
- SA
- GR



CALAMUS®

RO

## PB581 NOTES THERMO

notes in poliuretano termovirante  
 200 pagine a righe carta avorio  
 elastico in tinta, quadranti ad angoli tondi  
 portapenne, chiusura con elastico



- 📏 14x21 cm ca
- 📦 20/40 📦 CA SE



notes in  
 materiale  
 flessibile

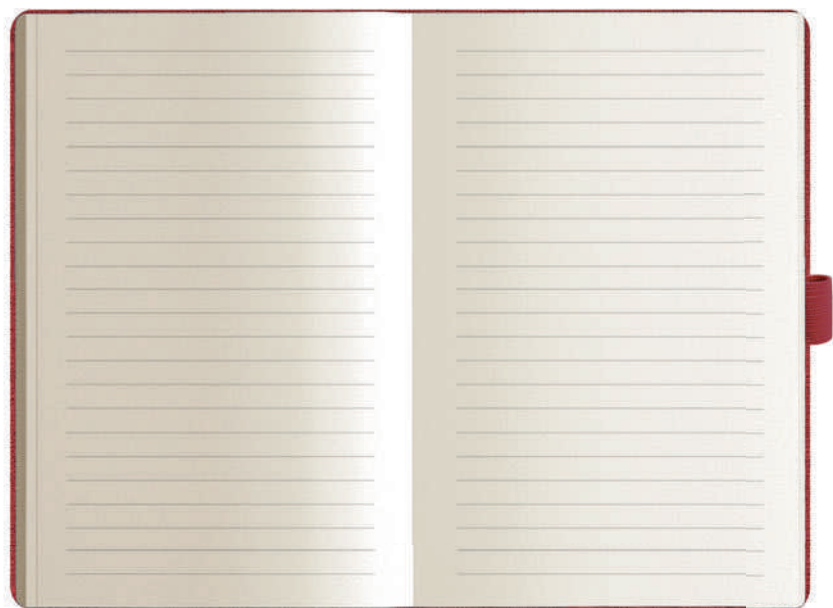

200 pagine a righe carta avorio

# TERMОВИRANTE

NEW!



## PB582 FLEX NOTES

notes in poliuretano termovirante  
224 pagine a righe carta bianca  
elastico in tinta, materiale flessibile



- 14x21 cm ca
- 10/50 CA SE

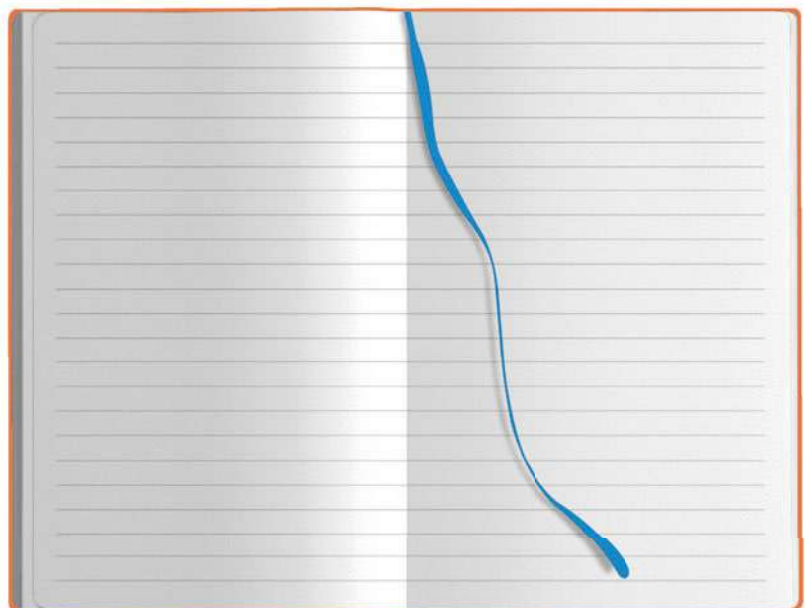

224 pagine a righe carta bianca



## PB594 NOTES WAVE

notes in poliestere e carta  
160 pagine a righe carta avorio  
segnapagina ed elastico in tinta  
quadranti ad angoli tondi  
portapenne



14x21 cm ca  
1/30 SE UV



BL



EC



GR



MA



NE

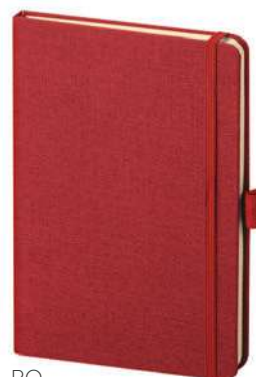

RO



VE



**PB599** NOTES MIDI

notes in midi cartonato  
 240 pagine neutre carta avorio  
 segnapagina ed elastico in tinta  
 quadranti ad angoli tondi  
 chiusura con elastico  
 astuccio su richiesta PB598



13x21 cm ca  
 20/40 SE UV

RO

160 pagine neutre carta avorio



AR

AZ

BI

BL

GR

NE

RO

RY

VE

VL

### PB600 NOTES PEN

notes in midi cartonato  
 240 pagine a righe carta avorio  
 segnapagina ed elastico in tinta  
 quadranti ad angoli tondi, portapenna  
 chiusura con elastico, tasca interna



13x21 cm ca  
 20/40 SE UV

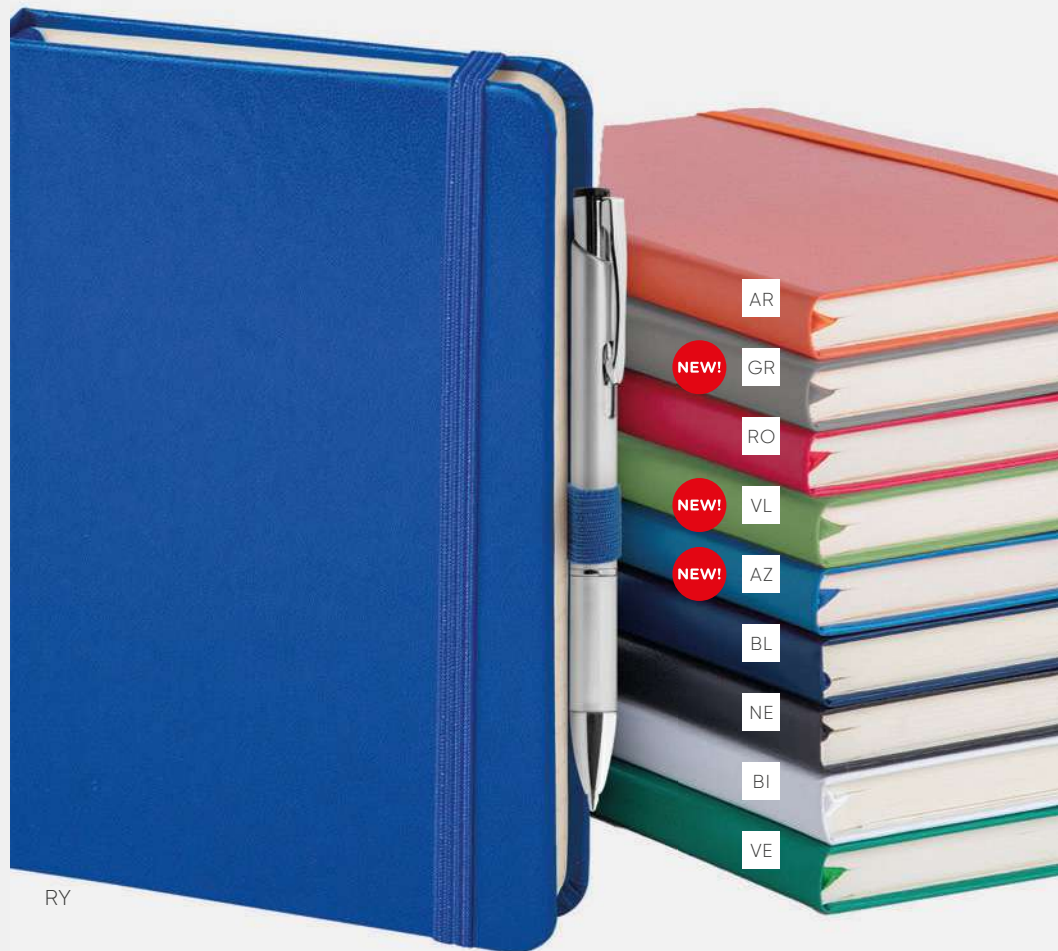
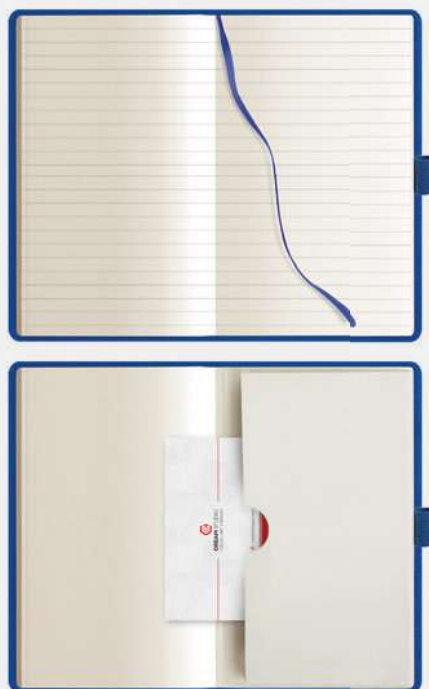

RY

- AR
- NEW! GR
- RO
- NEW! VL
- NEW! AZ
- BL
- NE
- BI
- VE



BL

### PB607 NOTES PEN CLASS

notes in midi cartonato, portapenna  
 160 pagine a righe carta avorio  
 segnapagina in tinta  
 quadranti ad angoli tondi



9x14 cm ca  
 20/80 SE UV

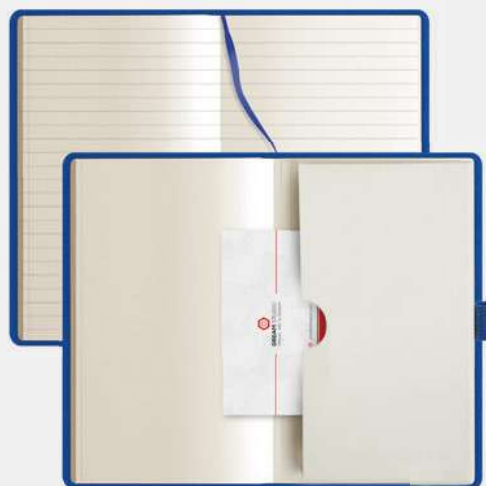



## NOTES IN MIDI CARTONATO

160 pagine carta bianca  
segnapagina ed elastico in tinta  
quadranti ad angoli tondi  
astuccio su richiesta PB609



NEW! AZ



### PB614 NOTES COLOR

160 pagine neutre carta bianca



9x14 cm ca  
20/80 SE UV

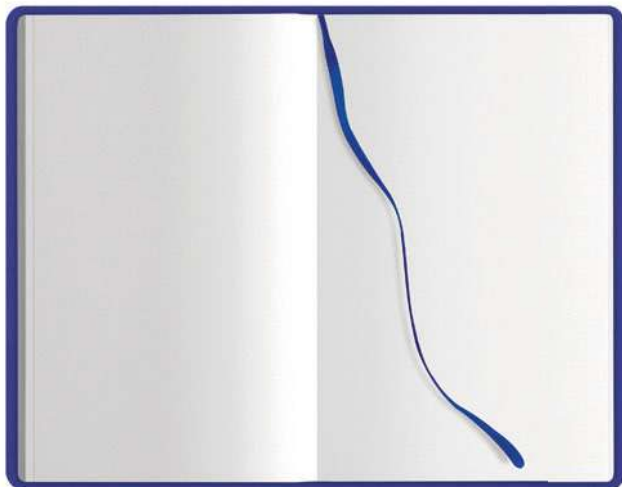

### PB616 NOTES LINE

160 pagine a righe carta bianca



9x14 cm ca  
20/80 SE UV

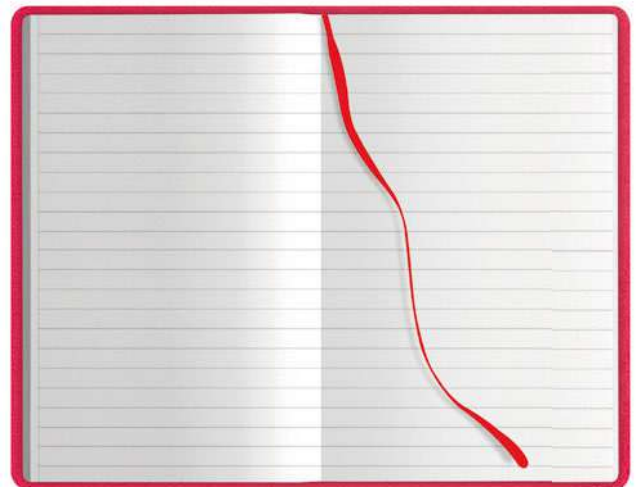



## NOTES IN **PU**

160 pagine a righe carta bianca  
elastico e segnapagina in tinta

### **PB620** NOTES



📏 14x21 cm ca  
📦 20/40 🌐 SE UV

### **PB621** NOTES TASCABILE



📏 9x14 cm ca  
📦 20/80 🌐 SE UV

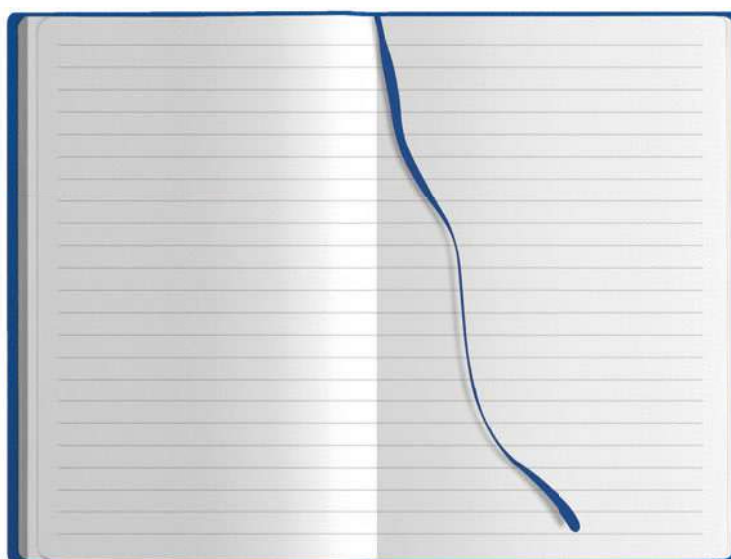

160 pagine a righe carta bianca



## PB495 PLANNING STICKERS

planning in carta 52 fogli settimanali, 4 blocchi fogli adesivi colorati, 5 blocchi segnapagina adesivi colorati  
penna in carta inclusa, banda per la personalizzazione 31x5 cm ca



31x17,5 cm ca  
25/50 SE UV



### PH619 MINI NOTES CARTOON

notes ecologico con spirale ed elastico  
70 fogli, penna in cartone riciclato inclusa



9,7x14,4x1 cm ca  
1/100 SE UV



70 fogli bianchi  
corredata di penna  
in cartone riciclato

SUSTAINABLE SELECTION

RO



SUSTAINABLE SELECTION

### PH625 NOTES MAGNET SET

set notes in carta  
1 blocco per appunti  
1 blocco fogli adesivi  
5 blocchi segnapagina colorati adesivi  
chiusura con calamita



8,3x13x1,2 cm ca  
50/200 SE UV



**PH630** NOTES CUBE

cubo notes in carta, 1 blocco foglio per appunti

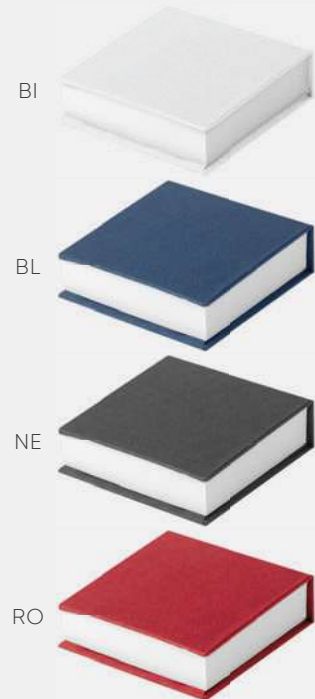

7,5x7,5x2,3 cm ca  
50/100 SE UV

**PH635** NOTES LETTER SET

set notes in carta  
1 blocco foglietti adesivi  
5 blocchi segnapagina colorati



8,2x8,2x0,7 cm ca  
100/400 SE UV



EC



NE



SUSTAINABLE  
SELECTION

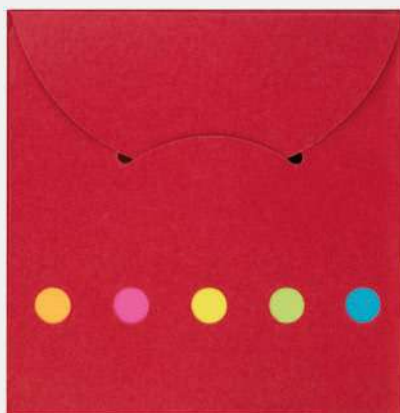

RO

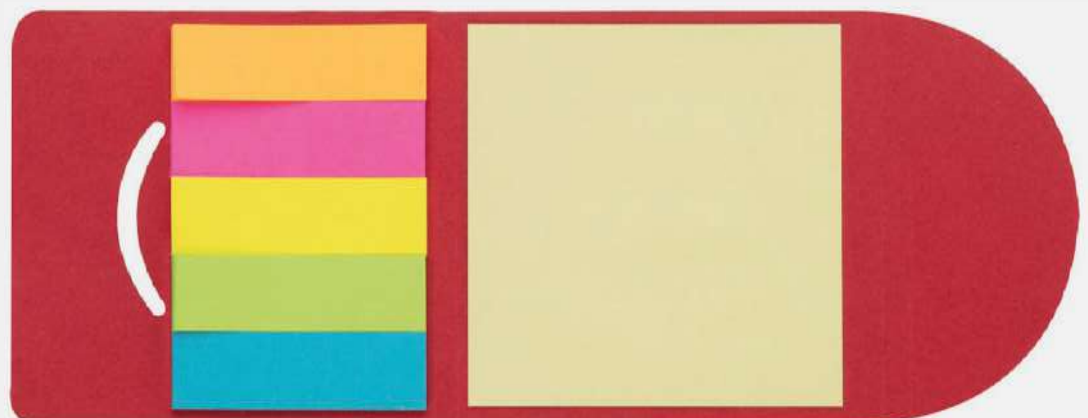



## PH640 NOTES DESK SET

set appunti da scrivania, 2 blocchi di fogli adesivi  
 righe in pvc, penna a sfera inchiostro nero  
 5 blocchi segnapagina colorati



12x10,5xh2,5 cm ca  
 50/100 SE UV



BL



EC



RO

**PF060 LAMP**

lampada USB  
abs gommato  
flessibile, 1 led



- 📏 16x1,5 cm ca
- 📦 50/200
- 🔌 SE TA UV



BI

NE



LAMPADA USB  
ORIENTABILE

**PH669 ROUND SUBLI**

tappetino mouse in poliester, base antiscivolo in silicone



- 📏 Ø 20 cm ca
- 📦 1/300
- 🔌 SU

**SPECIALE SUBLIMAZIONE**

La particolare superficie di questo tappetino mouse permette la personalizzazione tramite la tecnica di stampa sublimatica.

## SPECIALE SUBLIMAZIONE

La particolare superficie di questo mousepad permette la personalizzazione tramite la tecnica di stampa sublimatica.

La sublimazione garantisce un'ottima resa di stampa permettendoti di non avere limiti nella scelta di colori e soggetti.



### PH670 SUPER SUBLI

tappetino mouse in poliester



23x20 cm ca

200/200 SE TA SU (BI) UV



BI

**NEW!**  
**NUOVI  
COLORI:**

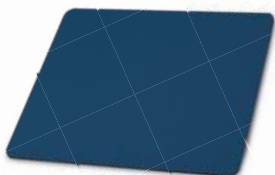

BL

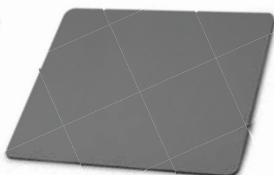

GR

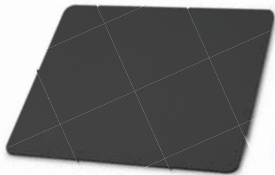

NE



RO

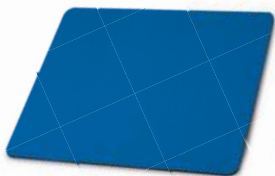

RY

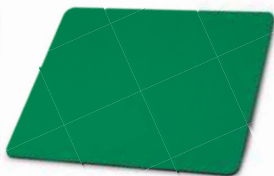

VE







RO

### PA782 CALENDAR PAD EDGE

tappetino mouse calendario in carta, pvc e eva  
12 mesi con note, copertina rigida in pvc, base in eva



23x18 cm ca  
200/200 DI SE UV



### MOUSE PAD CALENDARIO 2024

Con ampia fascia personalizzabile  
Mensili laterali  
Festività internazionali



BL



GR



VE



BI

### PH679 JERRYE

tappetino mouse in gomma e pvc



25,5x22 cm ca  
100/100 SE UV



BL



GR



**RIGHELLI  
DA 30 cm**

**PH810 WOODY**  
righello 30 cm in legno

SUSTAINABLE  
SELECTION

**RIGHELLO  
IN LEGNO  
30 cm**



- 31x3,6 cm ca
- 60/600 SE UV



**PH805 VISOR**  
righello 31 cm in plastica trasparente  
lente di ingrandimento  
fornito smontato senza inserto

Righello in plastica con  
lente d'ingrandimento



- 31,5x4,9 cm ca
- 250/250 DI SE UV

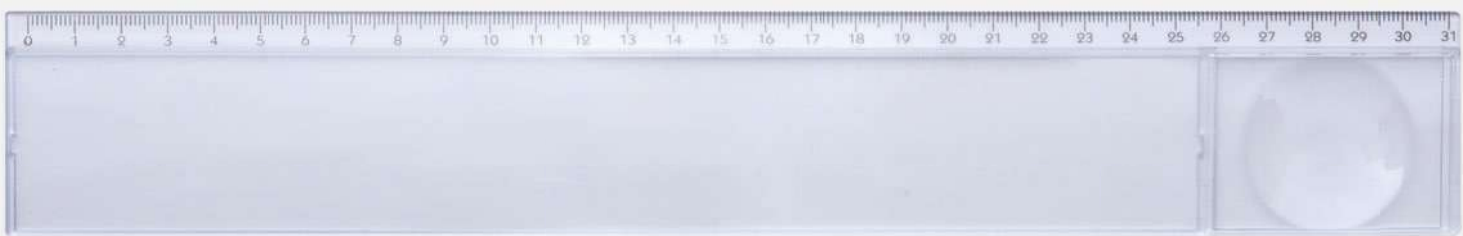

righello fornito smontato



cartoncino stampabile fronte/retro non incluso

**PH820 MISURA**

righello 30 cm in plastica



31x3,6 cm ca  
100/1000 SE UV

RIGHELLO IN PLASTICA  
CON FORO LATERALE  
30 cm

AZ



BI

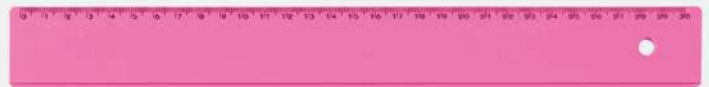

FX



GI



RO



VE



VF

**PH823 DIMENSIONE**

righello 30 cm in plastica



31x3 cm ca  
50/500 SE UV

RIGHELLO  
IN PLASTICA  
30 cm

RO



AR



AZ



BI



GI



NE



VE



VL

03.

BORRACCE  
E TAZZE



# SOSTENIBILITÀ AMBIENTALE

L'acqua è una risorsa preziosa e i problemi legati alla sua disponibilità interessano numerosi ambiti. I cambiamenti delle abitudini igieniche delle persone e la crescente urbanizzazione sono fattori critici che fanno prevedere nei prossimi anni un forte aumento della richiesta di acqua nelle città. L'accesso all'acqua potabile trasforma la povertà in possibilità. È il miglior investimento che il mondo possa fare per proteggere, prevenire e ridurre le malattie e salvare vite umane.



Milioni di persone possono ricevere un'enorme opportunità con un contributo minimo. Water.org ha contribuito a cambiare 45 milioni di vite, fornendo loro acqua potabile e/o servizi igienico-sanitari.

Noi abbiamo deciso di supportare le attività di Water.org donando una parte del ricavato della vendita delle nostre borracce.



**36 M** | 36 milioni di vite cambiate.

**11** | Operativi in 11 nazioni.

# PC414 STEEL BOTTLE 500

CAPACITÀ  
**500 ml**

**ACCIAIO  
INOX**

**DOPPIO  
STRATO**



compatibile col tappo **PC003**



compatibile col gancio **PC004**



**PC414 STEEL MAT BOTTLE 500**

borraccia termica in acciaio inox 500 ml, finitura lacca opaca  
doppio strato (304-201), tappo in acciaio inox

CAPACITÀ  
**500 ml**

**DOPPIO  
STRATO**

**ACCIAIO  
INOX**



☑ Ø 6,5xh26,5 cm ca  
📦 1/24 🏠 IN TA



Borraccia  
abbinabile  
al tappo:

**NEW!**

**PC003 PUSH LID**

tappo a pressione



☑ Ø 4,2x5,2h cm ca  
📦 1/100



Borraccia  
abbinabile  
al gancio:

**NEW!**

**PC004 GANCIO**

gancio per borraccia



☑ Ø 2,7x9 cm ca  
📦 1/100



# PC416 STEEL MAT BOTTLE 500 FLAT

CAPACITÀ  
**500 ml**

**NEW!**

**ACCIAIO  
INOX**

**DOPPIO  
STRATO**



compatibile col tappo **PC003**



collo della borraccia compatibile col gancio **PC004**



**PC416 STEEL MAT BOTTLE 500 FLAT**

borraccia in acciaio inox 304/201. tappo in acciaio doppio strato, capacità 500 ml, rifinitura matta, box incluso



☑ Ø 6,5xh26,5 cm ca  
 ☑ 1/24 ☑ IN TA

CAPACITÀ  
**500 ml**

**DOPPIO  
 STRATO**

**ACCIAIO  
 INOX**

**NEW!**



Borraccia  
 abbinabile  
 al tappo:

**NEW!**

**PC003 PUSH LID**

tappo a pressione



☑ Ø 4,2x5,2h cm ca  
 ☑ 1/100



Borraccia  
 abbinabile  
 al gancio:

**NEW!**

**PC004 GANCIO**

gancio per borraccia



☑ Ø 2,7x9 cm ca  
 ☑ 1/100



# BORRACCE IN ACCIAIO INOX 304/201 **DOPPIO STRATO**

tappo in acciaio  
finitura opaca  
box incluso



**PC415**  
500 ml

**PC418**  
750 ml



**PC418BL**

**PC415VE**



compatibile con il tappo in bamboo **PC001**



compatibile con il tappo in bamboo **PC002**

**PC415 MATTE BOTTLE 500**

capacità 500 ml



☑ Ø 7,3xh22,7 cm ca  
 ☐ 1/24 ☒ IN TA



BI



BL



GI



NE



RO



VE



VS

**ACCIAIO  
INOX****DOPPIO  
STRATO**

Borraccia abbinabile ai tappi:

**PC001 BAMBOO LID**

tappo in bamboo



☑ Ø 5xh4 cm ca  
 ☐ 1/100

**PC002 BAMBOO LID LACE**

tappo in bamboo



☑ Ø 5xh4 cm ca  
 ☐ 1/100



BORRACCE  
IN ACCIAIO  
INOX 304/201  
**DOPPIO STRATO**

tappo in acciaio  
rifinitura opaca metallica  
box incluso



PC417  
500 ml

PC419  
750 ml



PC417RG

PC419OR



compatibile con il tappo in bamboo **PC001**



compatibile con il tappo in bamboo **PC002**

NEW!

**PC417 METAMAT 500**

capacità 500 ml



☑ Ø 7,3xh22,7 cm ca

📦 1/24 🏠 IN TA

**ACCIAIO  
INOX****DOPPIO  
STRATO****PC419 METAMAT 750**

capacità 750 ml



☑ Ø 7,5xh26 cm ca

📦 1/24 🏠 IN TA

NEW!



OR



RG



SI

Borraccia abbinabile ai tappi:

**PC001 BAMBOO LID**

NEW!

tappo in bamboo



☑ Ø 5xh4 cm ca

📦 1/100

**PC002 BAMBOO LID LACE**

NEW!

tappo in bamboo



☑ Ø 5xh4 cm ca

📦 1/100



BORRACCE IN ACCIAIO  
INOX 304/201  
**DOPPIO STRATO**



tappo in bamboo ed acciaio  
rifinitura opaca, box incluso

**PC431** OUTDOOR BOTTLE 500  
capacità 500 ml



☑️ Ø 7xh20 cm ca  
📦 1/24 🏠 IN TA

**PC437** OUTDOOR BOTTLE 750  
capacità 750 ml



☑️ Ø 7xh26,5 cm ca  
📦 1/24 🏠 IN TA



BI

RO

VS



CAPACITÀ  
**500 ml**

CAPACITÀ  
**750 ml**



PC431BL

PC437NE



cannuccia antibatterica integrata

BORRACCE IN  
ACCIAIO INOX  
304/201  
**DOPPIO STRATO**

**ACCIAIO  
INOX**

**DOPPIO  
STRATO**

CAPACITÀ  
**330 ml**



CAPACITÀ  
**500 ml**

**PC435BL**



**PC434RO**

**PC434 STEEL CAN 330**  
capacità 330 ml



☐ Ø 6,3xh13,5 cm ca  
☐ 1/60 ☐ IN TA

**PC435 STEEL CAN 500**  
capacità 500 ml



☐ Ø 6,3xh17,5 cm ca  
☐ 1/30 ☐ IN TA



BL

NE



AR

GI

NE

RO

VE

**SINGOLO STRATO**

**ACCIAIO INOX**

**PC411 GLOSSY BOTTLE 500**

borraccia singolo strato in acciaio inox 304 500 ml, tappo in acciaio, finitura lucida, box incluso



☑ Ø 6,5xh22 cm ca

📦 1/24 🏠 IN TA



**PC421 STEEL DRINK 750**

borraccia singolo strato in acciaio inox 304 750 ml tappo in acciaio inox, finitura lucida



☑ Ø 7xh26 cm ca

📦 1/36 🏠 IN TA



CAPACITÀ  
**750 ml**

CAPACITÀ  
**500 ml**

**NEW!**



**PC411VE**

**PC421RO**

Borraccia  
abbinabile  
al gancio:

**NEW!**

**PC004 GANCIO**

gancio per borraccia



☑ Ø 2,7x9 cm ca

📦 1/100





**PC408 SILVER DRINK**

borraccia acciaio 304  
 singolo strato - 500 ml  
 tappo di sicurezza avvitabile  
 moschettone in metallo



☑ Ø 6,5xh20 cm ca  
 ☑ 1/60 ☑ IN TA UV

**SINGOLO  
STRATO**

**ACCIAIO  
INOX**

**PC413 COLOR DRINK**

borraccia acciaio 304  
 singolo strato - 500 ml  
 tappo di sicurezza avvitabile  
 moschettone in metallo



☑ Ø 6,5xh20 cm ca  
 ☑ 1/60 ☑ IN TA UV



PC413AR



PC413BI



PC413BL



PC413GI



PC413NE



PC413VE

# BORRACCE IN ACCIAIO SPECIALE SUBLIMAZIONE

La sublimazione garantisce un'ottima resa di stampa permettendoti di non avere limiti nella scelta di colori e soggetti.



cannuccia antibatterica integrata

CAPACITÀ  
**500 ml**



**24h**  
cold  
**12h**  
hot

CAPACITÀ  
**330 ml**



## BORRACCE IN ACCIAIO INOX 304/201 DOPPIO STRATO

con cannuccia  
antibatterica  
integrata

**PC433** STEEL SUBLI CAN 330  
capacità 330 ml



☑ Ø 6,3xh13,5 cm ca  
☑ 1/60 ☑ SU

**PC436** STEEL SUBLI CAN 500  
capacità 500 ml



☑ Ø 6,3xh17,5 cm ca  
☑ 1/30 ☑ SU



## BORRACCE IN ACCIAIO SPECIALE SUBLIMAZIONE

La particolare superficie di queste borracce permette la personalizzazione tramite la tecnica di stampa sublimatica.

### PC428 SNOWFLAKE 750

borraccia in acciaio inox 304  
singolo strato, capacità 750 ml  
tappo in acciaio, finitura lucida



☑ Ø 7xh26 cm ca  
☑ 1/36 ☑ SU

NEW!

### PC438 SNOWFLAKE 500

borraccia in acciaio inox 304  
singolo strato, capacità 500 ml  
tappo in acciaio, finitura lucida



☑ Ø 6,5xh22 cm ca  
☑ 1/24 ☑ SU

Borracce  
abbinabili  
al gancio:

NEW!

### PC004 GANCIO

gancio per borraccia



☑ Ø 2,7x9 cm ca  
☑ 1/100



ACCIAIO  
INOX

SINGOLO  
STRATO

CAPACITÀ  
500 ml



CAPACITÀ  
750 ml



PC428



NEW!

PC438

# SPECIALE SUBLIMAZIONE

## PC432 SNOWFLAKE DOUBLE 500

borraccia in acciaio inox 304/201  
doppio strato, capacità 500 ml  
tappo in acciaio, finitura lucida



☐ Ø 6,5x26,5 cm ca  
📦 1/24 🏠 SU



compatibile col tappo **PC003**



compatibile col gancio **PC004**



Borraccia  
abbinabile  
al tappo:

**NEW!**

### PC003 PUSH LID

tappo a pressione



☐ Ø 4,2x5,2h cm ca  
📦 1/100



Borraccia  
abbinabile  
al gancio:

**NEW!**

### PC004 GANCIO

gancio per borraccia



☐ Ø 2,7x9 cm ca  
📦 1/100



**PC430 MIRAGE**

borraccia in alluminio 650 ml  
tappo di sicurezza avvitabile  
finitura lucida, nastro personalizzabile



Ø 6,6xh23 cm ca  
1/60 SU



AR



BL



NE



VE

## SPECIALE SUBLIMAZIONE

La sublimazione garantisce un'ottima resa di stampa permettendoti di non avere limiti nella scelta di colori e soggetti.

**PC426** SUBLI DRINK 500

borraccia alluminio 500 ml  
tappo di sicurezza avvitabile  
moschettone in metallo  
finitura lucida



☑ Ø 6,5xh21 cm ca  
📦 1/60 🌐 SU

**Aluminium**  
promotional concept®

**PC427** SUBLI DRINK 750

borraccia alluminio 750 ml  
tappo di sicurezza avvitabile  
moschettone in metallo  
finitura lucida



☑ Ø 7,3xh24,5 cm ca  
📦 1/60 🌐 SU

CAPACITÀ  
**500 ml**



PC426

CAPACITÀ  
**750 ml**



PC427

## BORRACCE IN ALLUMINIO SPECIALE SUBLIMAZIONE

La particolare superficie di queste borracce permette la personalizzazione tramite la tecnica di stampa sublimatica.

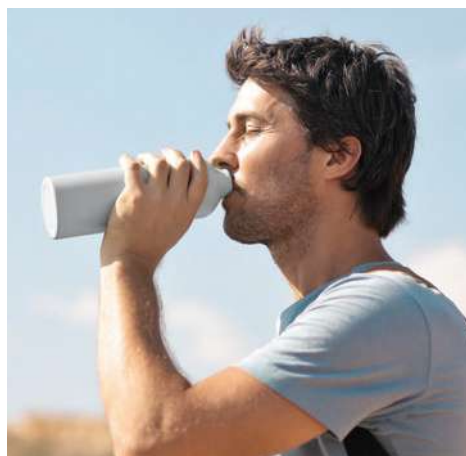

**PC484 ALUM DRINK 500**

borraccia alluminio 500 ml  
 tappo di sicurezza avvitabile  
 moschettone in metallo  
 finitura lucida



☐ Ø 6,5xh20,5 cm ca  
 ☐ 1/100 ☐ IN TA UV



AR

AZ

BI

GI

NE

RO

SI

VE

### PC490 ALUM DRINK 1000

borraccia alluminio 1000 ml  
tappo di sicurezza avvitabile  
moschettone in metallo  
finitura lucida



☐ Ø 8xh26,5 cm ca  
📦 1/60 🏠 IN TA UV



BI BL NE SI

### PC493 ALUM DRINK 750

borraccia alluminio 750 ml  
tappo di sicurezza avvitabile  
moschettone in metallo  
finitura lucida



☐ Ø 7,3xh24,5 cm ca  
📦 1/60 🏠 IN TA UV



AR BI NE



RO SI VE



CAPACITÀ  
**750 ml**

CAPACITÀ  
**1000 ml**



PC493BL

PC490RO



**PC494 ALUM BOTTLE 600**

borraccia alluminio 600 ml  
tappo in acciaio avvitabile  
finitura lacca opaca



☑ Ø 6,5x24 cm ca  
📦 1/60 🌐 IN TA



AR



NE



**Aluminium**  
promotional concept®

CAPACITÀ  
**600 ml**

RO



Borraccia  
abbinabile  
al gancio:

NEW!

**PC004 GANCIO**  
gancio per borraccia



☑ Ø 2,7x9 cm ca  
📦 1/100



**PC496** CRIO

borraccia in tritan 500 ml  
 tappo di sicurezza avvitabile  
 BPA free



☐ Ø 6,5xh20,5 cm ca  
 ☐ 1/60 ☐ SE TA

**BORRACCIA  
 BPA FREE  
 SENZA  
 BISFENOLO**

MANEGGEVOLE E  
 RESISTENTE AGLI URTI

PRATICA DA PORTARE  
 E DA LAVARE



AR



BI



NE



RO



VE

**PC001 BAMBOO LID**

tappo in bamboo  
compatibile con PC415 PC418 PC417 PC419



☑ Ø 5x4 cm ca  
📦 1/100

**PC002 BAMBOO LID LACE**

tappo in bamboo con laccio  
compatibile con PC415 PC418 PC417 PC419



☑ Ø 5x4 cm ca  
📦 1/100

**PC003 PUSH LID**

tappo a pressione  
compatibile con PC414 PC416 PC432



☑ Ø 4,2x5,2h cm ca  
📦 1/100

**PC004 GANCIO**

gancio borraccia, compatibile con: PC411 PC414  
PC416 PC421 PC428 PC432 PC438 PC494



☑ Ø 2,7x9 cm ca  
📦 1/100



TAZZE IN CERAMICA  
QUALITÀ AAA



NEW!



NEW!



**PC290BI**  
finitura lucida



**PC295BI**  
finitura opaca

**PC290** SUBLI MUG AAA GLOSSY

tazza in ceramica, qualità AAA, finitura lucida  
capacità 0,32 L, confezione in scatola singola



☑ Ø 8xh9,5 cm ca  
☑ 36/36 ☑ SU

scatola singola  
con finestra

NEW!



**PC295** SUBLI MUG AAA MATTE

tazza in ceramica, qualità AAA, finitura opaca  
capacità 0,32 L, confezione in scatola singola



☑ Ø 8xh9,5 cm ca  
☑ 36/36 ☑ SU

scatola singola  
con finestra

NEW!



## SPECIALE SUBLIMAZIONE

La sublimazione garantisce un'ottima resa di stampa permettendoti di non avere limiti nella scelta di colori e soggetti.



### PC466 SUBLI MUG BOX

tazza in ceramica, capacità 0,32 L  
confezione in scatola singola



📏 Ø 8xh9,5 cm ca  
📦 36/36 🏠 SU

scatola singola  
con finestra



## SPECIALE SUBLIMAZIONE

La particolare superficie di queste tazze permette la personalizzazione tramite la stampa sublimatica.



### PC467 SUBLI COLOR MUG

tazza in ceramica bicolore, capacità 0,32 L  
confezione in scatola singola



☑️ Ø 8xh9,5 cm ca  
📦 36/36 🏠 SU



scatola singola  
con finestra



### PC467NB COLOR MUG SIMPLY

tazza in ceramica bicolore, capacità 0,32 L  
fornita senza scatola



☑️ Ø 8xh9,5 cm ca  
📦 36/36 🏠 SU

## TAZZE IN VETRO TRASPARENTE

con fondo colorato



### PC365 GLASS COLOR MUG

tazza in vetro capacità 320ml, fondo colorato



☞ Ø 8xh9,5 cm ca  
☞ 48/48 ☞ IN TA SE

**AS400** Astuccio su richiesta



**PC370** ICE MUG

tazza in vetro effetto ghiaccio  
capacità 320ml



☐ Ø 8xh9,5 cm ca  
☐ 48/48 ☐ IN TA

**AS400** Astuccio su richiesta

**PC375** ICE COLOR MUG

tazza in vetro effetto ghiaccio  
fondo colorato, capacità 320ml



☐ Ø 8xh9,5 cm ca  
☐ 48/48 ☐ IN TA

**AS400** Astuccio su richiesta







### PC478 JAR GLASS

vasetto in vetro robusto, coperchio a vite ermetico, fessura per cannuccia, capacità 500ml



☐ Ø 6,5x12,5 cm ca  
 ☐ 36/36 ☐ IN SE TA UV



GI



RO



SI



VE

LUNCH BOX  
PERFETTI PER  
**LA TUA PAUSA  
PRANZO**

Una selezione di  
lunch box a singolo  
e doppio scomparto.

COMPLIANCE FOR  
FOOD CONTACT  
MATERIAL  
(Conformità MOCA)



**PC393 LUNCH BAMBOO**

porta pranzo in PP e bamboo, vano contenitore singolo  
1000 ml, coperchio in bamboo, cinghia di sicurezza esterna

NEW!



20x14x6,5 cm ca

1/30 SE TA



EC



GR



NE



BI



NE

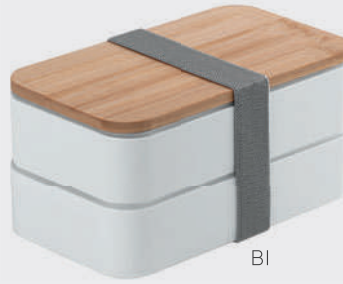

BI

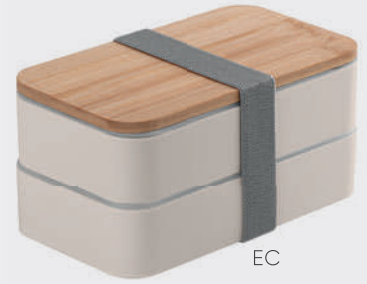

EC

NEW!

CHiusura  
ERMETICA

### PC392 LUNCH BAMBOO DOUBLE

porta pranzo in PP e bamboo 1400 ml  
doppio vano contenitore, coperchi ermetici  
inserti porta posate, set posate incluso  
cinghia di sicurezza esterna



18,5x10,5x10 cm ca  
1/30 SE TA

COMPLIANCE FOR  
FOOD CONTACT  
MATERIAL  
(Conformità MOCA)



doppio scomparto  
con set di posate



VE



BI



EC



GR

NEW!

CHiusura  
ERMETICA

### PC394 LUNCH DOUBLE

porta pranzo in PP 1400 ml  
doppio vano contenitore, coperchi ermetici  
inserti porta posate, set posate incluso  
cinghia di sicurezza esterna



18,5x10,5x10 cm ca  
1/30 SE TA

COMPLIANCE FOR  
FOOD CONTACT  
MATERIAL  
(Conformità MOCA)



doppio scomparto  
con set di posate



04.

RISTORAZIONE  
E CUCINA



**PG128** MARINARA

borsa porta pizze in tnt  
manici corti, laccio di chiusura  
cuciture rinforzate



36x37x36 cm ca

10/100 SE



RO

BORSA  
PORTA PIZZA  
**CAPIENZA  
6 PEZZI**



BI



IT



VE

# BOX PORTA BOTTIGLIE 2 UNITÀ

## PG080 WINE BOX

carta bianca



17,5x8,5x35 cm ca

20/20 SE

## PG081 WINE BOX

carta avana



17,5x8,5x35 cm ca

20/20 SE



PG080



PG081



## PG102 NEBBIOLO

borsa vino in polipropilene  
finitura lucida, soffiato  
manici lunghi, 6 scomparti



28x28x18 cm ca

25/200 SE



BL



NE

## PG104 CHARDONNAY

borsa vino in polipropilene  
finitura lucida, soffiato  
manici lunghi, 4 scomparti



18x28x18 cm ca

25/200 SE



BO



NE



BO



BL

# BORSE PORTA VINO



NEW!

PG111BL

NEW!

PG112NE

## PG111 CHIANTI

borsa vino in tnt, manici corti



10x36x10 cm ca  
50/450 SE

NEW!



## PG112 BAROLO

borsa vino in tnt, capienza 2 bottiglie



16,5x35x9 cm ca  
20/200 SE

NEW!



BL

BO



PG115BL

NEW!



Laccio di chiusura personalizzabile in matching color

PG116BO

**PG115 BOLLICINE**

borsa vino in tnt, laccio di chiusura, cuciture termiche



15x40x6 cm ca  
50/250 SE

NEW!

**PG116 BORDELAIS**

borsa vino in tnt, cuciture termiche



16x40x6,5 cm ca  
20/400 SE



BO

NE

VE



BL

NE

VE



## BORSE PORTA BOTTIGLIA

cotone e juta laminata  
manici corti, 220 g/mq

### PG446 DOUBLE PRESENT

2 bottiglie



- ☑ 20x35x10 cm ca
- ☑ 220 g/mq
- ☑ 10/100 ☑ SE

### PG448 PRESENT

1 bottiglia



- ☑ 11x35x10 cm ca
- ☑ 220 g/mq
- ☑ 10/200 ☑ SE



COTONE  
LAMINATO  
E JUTA



### PC456 CRISTAL

cestello in pvc resistente  
p/ghiaccio, p/bottiglia  
tenuta stagna



- ☑ 11x28x11 cm ca
- ☑ 25/200 ☑ SE

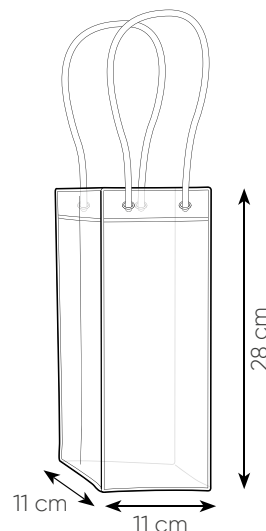



**PC487 FLUTE**

portacalice in tnt con tracolla  
rifiniture cucite, profondità 6 cm ca



18x23,5 cm ca

10/800 SE



**PC500 RESTAURANT**

bavaglio ristorante in tnt



35x44 cm ca

50/400 SE



**PC579 CATERING**

grembiule in policotton  
65% poliestere 35% cotone  
tascone laterale, 200 g/m<sup>2</sup>



75x80 cm ca 10/100

DI(BI) SE SU(BI) TR



BI



BL



BO



NE



**GREMBIULE CON TASCONE  
SUL LATO DESTRO**



3 tasche frontali

**PC602BO**



1 tascone sul lato destro

**PC606BI**

**PC602 BAR**

sinilino da bar  
65% poliestere 35% cotone  
3 tasche frontali, 200 g/m<sup>2</sup>



50x33 cm ca  
10/200 SE TR



BI



NE

**PC606 COOK**

grebiule da chef  
200 g/m<sup>2</sup>  
tascone laterale



70x85 cm ca  
10/50 DI SE TR

**PC605 CHEF**

grebiule da chef 100% cotone 200 g/m<sup>2</sup>  
tascone laterale colore BI  
tascone centrale colori RO - VE



60x90 cm ca

10/50 DI SE TR



**100% COTONE**



200  
gsm



BI



BI

**Colore bianco:**  
tascone lato destro



RO

**Colore rosso:**  
tascone centrale



VE

**Colore verde:**  
tascone centrale



**PC607 NATURAL**

grembiule con pettorina 100% cotone 100 g/m<sup>2</sup>



55x75 cm ca

10/50 SE TR



100% COTONE



**GREMBIULE  
RICICLABILE  
SPECIALE  
SUBLIMAZIONE**

Questo grembiule è realizzato in PET, materiale riciclabile che permette la personalizzazione tramite la tecnica di stampa sublimatica.



**PC608 SUBLIM**

grembiule in PET 80 g/m<sup>2</sup>  
rifinito con fettuccia



60x90 cm ca

10/50 SE TR SU



**NEW!** PC085TR



**NEW!** PC086TR



**NEW!** PC087TR



**NEW!** PC088TR



# DISPLAY IN ACRILICO TRASPARENTE



**PC085TR DISPLAY XL**

formato A4 monofacciale  
cartoncino non incluso



- 📏 21x29,7 cm ca
- 📦 1/30
- 📏 DI SE UV

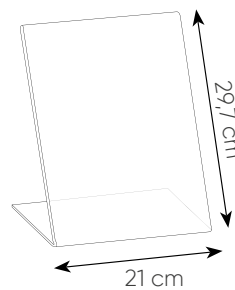

**PC086TR DISPLAY L**

formato A5 monofacciale  
cartoncino non incluso



- 📏 14,8x21 cm ca
- 📦 1/48
- 📏 DI SE UV

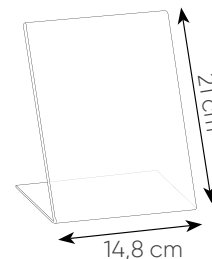

**PC087TR DISPLAY M**

formato A6 monofacciale  
cartoncino non incluso



- 📏 10,5x14,5 cm ca
- 📦 1/60
- 📏 DI SE UV

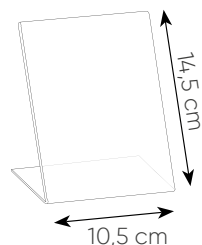

**PC088TR DISPLAY S**

formato A7 monofacciale  
cartoncino non incluso



- 📏 7,4x10,5 cm ca
- 📦 1/90
- 📏 DI SE UV

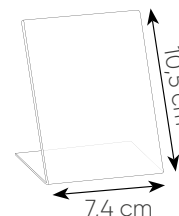

# DOUBLE DISPLAY IN ACRILICO TRASPARENTE BIFACCIALE



PC089TR **NEW!**



PC090TR **NEW!**



PC091TR **NEW!**



PC092TR **NEW!**

## PC089TR DISPLAY XL

formato A4 bifacciale  
cartoncino non incluso



- 📏 21x29,7 cm ca
- 📦 1/26
- 📍 DI SE UV

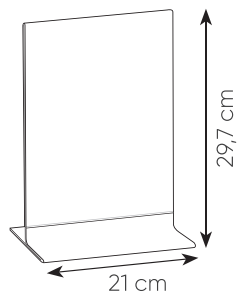

## PC090TR DISPLAY L

formato A5 bifacciale  
cartoncino non incluso



- 📏 14,8x21 cm ca
- 📦 1/48
- 📍 DI SE UV

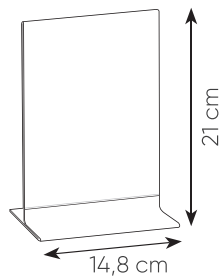

## PC091TR DISPLAY M

formato A6 bifacciale  
cartoncino non incluso



- 📏 10,5x14,5 cm ca
- 📦 1/38
- 📍 DI SE UV

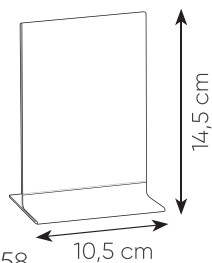

## PC092TR DISPLAY S

formato A7 bifacciale  
cartoncino non incluso



- 📏 7,4x10,5 cm ca
- 📦 1/100
- 📍 DI SE UV

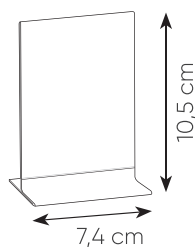



## SEGNAPOSTO BIFACCIALE IN ACRILICO TRASPARENTE

**PC696TR** POSTO  
cartoncino non incluso



13x6 cm ca  
1/80 DI SE UV

**PC697TR** MINI POSTO  
cartoncino non incluso



5,5x5,5 cm ca  
1/176 DI SE UV



## **PC690** HOTELLERIE

rendiresto in similpelle, angoli dorati  
cornice, tasca interna



chiuso: 12x21x1,5 cm ca  
1/20 SE UV

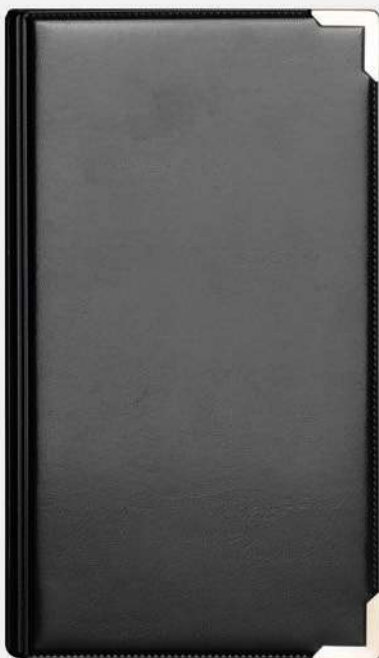

NE



BO

RENDIRESTO  
**IN SIMILPELLE**



PORTA  
MENU  
**2 ANTE  
8 TASCHE**

**PC670 BREAK**  
porta menù maxi in similpelle



23,5x31,7 cm ca  
1/24 SE UV

**PC675 DINNER**  
porta menù in similpelle



16,2x26 cm ca  
1/20 SE UV

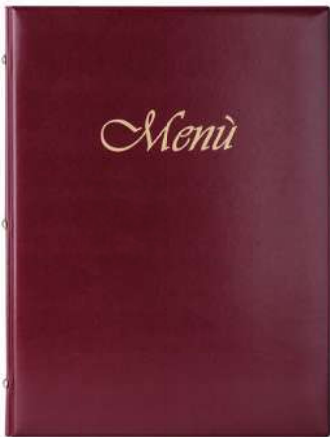

BO

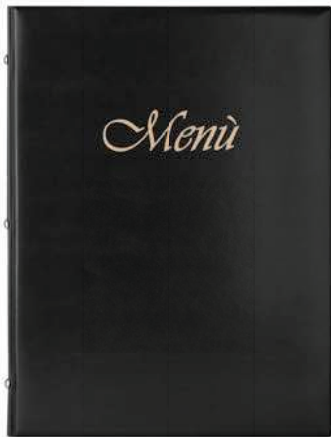

NE

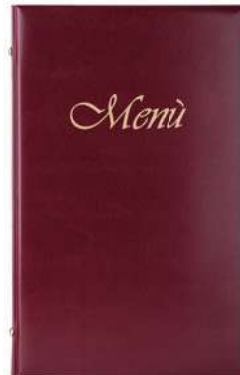

BO



NE



cavatappi

**PC760 WINO**

set da vino in sughero e metallo  
4 accessori inclusi:  
salvagoccia, tappo ermetico  
versatore, cavatappi multifunzione



☑️ Ø 15x4 cm ca  
📦 1/20 🏠 DI SE TA

ASTUCCIO  
PERSONALIZZABILE  
**EFFETTO SUGHERO**



NE

**PC765 SOMMELIER**

cavatappi apribottiglie  
metallo cromato, 3 funzioni  
doppia leva per l'estrazione del tappo  
corredato di astuccio



☑️ 12,3x2,2x1,6 cm ca  
📦 20/200 🏠 IN SE TA UV



BI



BO



VL

### PC775 TRIPLE

cavatappi apribottiglie, metallo cromato  
doppia leva per l'estrazione del tappo  
3 funzioni, corredato di astuccio



12x2,2x1 cm ca  
20/200 IN SE TA UV



### PC786 SCOUT

coltello in plastica e acciaio temperato  
11 funzioni, corredato di astuccio



9x2,5 cm ca  
10/120 SE TA UV



SUSTAINABLE  
SELECTION

PC780

PC783

**PC780** MULTI-TOOL 11

coltellino apribottiglie  
legno e acciaio temperato  
11 funzioni, corredato di astuccio



9x2,5 cm ca  
20/200 IN SE TA UV

**PC783** MULTI-TOOL 3

portachiavi coltellino in legno 3 funzioni  
anello piatto, corredato di astuccio



1,8x5,9 cm ca  
72/288 IN SE TA UV



SUSTAINABLE SELECTION



PC801 BAMBOO OPENER

apribottiglia in bamboo e metallo magneti per aggancio su frigorifero



☑ Ø 6x1 cm ca  
 ☑ 50/500 ☑ IN SE TA UV



PC812 DOUBLE BOTTLE

apribottiglie in plastica e metallo spinner



☑ 9x3 cm ca  
 ☑ 50/500 ☑ SE TA UV



VE



AR



BI



BL



BO



RO

DOPPIO USO  
**APRIBOTTIGLIE  
 E SPINNER**

**PC815 BOIRE**

apribottiglie/tappo in plastica e metallo



- 9x4x1 cm ca
- 50/500
- SE TA UV



RO

**PC715 CAPRICCIOSA**

rotella tagliapizza in plastica e metallo, apribottiglie



- 13x6,3 cm ca
- 50/250
- SE TA UV



BL



BI

RO

VE



05.

SHOPPERS





PRODOTTO



ITALIANO

SHOPPERS  
IN CARTA  
**AVANA  
COLORATA**

PG015

PG014

PG013

PG012

PG011



Maniglia ritorta  
in colore naturale

## Shoppers in colori pastello

carta avana colorata  
maniglia ritorta  
soffietto

### PG015

portata 11 kg



45x48x20 cm ca  
120 g/mq  
200/200 SE



### PG014

portata 9 kg



36x41x12 cm ca  
90 g/mq  
200/200 SE



### PG013

portata 5,5 kg



28x39x10 cm ca  
90 g/mq  
200/200 SE



### PG012

portata 5,5 kg



22x29x10 cm ca  
80 g/mq  
200/200 SE



### PG011

portata 2 kg



18x21x8 cm ca  
80 g/mq  
375/375t SE



PRODOTTO  
  
 ITALIANO

SHOPPERS IN  
 CARTA KRAFT  
 COLORATA



PG032



PG033



PG034







PG035

## Shoppers in carta colorata

### PG032

portata 11 kg



-  45x48x20 cm ca
-  110 g/mq
-  200/200 







carta kraft bianca  
 maniglia ritorta  
 soffietto

### PG033

portata 9 kg







-  36x41x12 cm ca
-  100 g/mq
-  200/200 



### PG034

portata 5,5 kg







-  28x39x12 cm ca
-  90 g/mq
-  200/200 



### PG035

portata 5,5 kg



-  22x29x10 cm ca
-  90 g/mq
-  200/200 



Maniglia ritorta  
 in tinta



PRODOTTO  
  
 ITALIANO

SHOPPERS IN  
**CARTA KRAFT  
 BIANCA**

## Shoppers in carta bianca

carta kraft bianca  
 maniglia ritorta  
 soffiato



### PG036

portata 11 kg



54x50x14 cm ca  
 120 g/mq  
 150/150 SE

### PG037

portata 11 kg



45x48x20 cm ca  
 110 g/mq  
 200/200 SE

### PG038

portata 9 kg



36x41x12 cm ca  
 100 g/mq  
 200/200 SE

### PG039

portata 5,5 kg



28x39x10 cm ca  
 90 g/mq  
 200/200 SE

### PG040

portata 5,5 kg



22x29x10 cm ca  
 90 g/mq  
 200/200 SE

### PG041

portata 2 kg



18x21x8 cm ca  
 80 g/mq  
 400/400 SE

## SHOPPERS IN CARTA AVANA RICICLATA

PRODOTTO



ITALIANO

PG055

PG054

PG053

PG052

PG051



## Shoppers in colore naturale

carta avana riciclata  
maniglia ritorta  
soffietto

### PG051

portata 2 kg



- 18x21x8 cm ca
- 80 g/mq
- 375/375 SE

### PG052

portata 5,5 kg



- 22x29x10 cm ca
- 80 g/mq
- 200/200 SE

### PG053

portata 5,5 kg



- 28x39x10 cm ca
- 90 g/mq
- 200/200 SE

### PG054

portata 9 kg



- 36x41x12 cm ca
- 90 g/mq
- 200/200 SE

### PG055

portata 11 kg



- 45x48x20 cm ca
- 120 g/mq
- 200/200 SE



Maniglia ritorta  
in colore naturale

PRODOTTO  
  
 ITALIANO

SHOPPERS IN  
 CARTA KRAFT  
 COLORATA



Maniglia piatta in tinta





Shoppers  
 colorate

carta kraft colorata  
 maniglia piatta  
 soffiato

**PG061**

portata 12 kg







-  45x48x15 cm ca
-  110 g/mq
-  250/250 



**PG062**

portata 10 kg







-  32x43x17 cm ca
-  100 g/mq
-  250/250 



**PG063**

portata 6 kg







-  26x39x14 cm ca
-  90 g/mq
-  250/250 



**PG064**

portata 6 kg







-  22x29x10 cm ca
-  90 g/mq
-  300/300 



**PG065**

portata 6 kg



-  19x24x7 cm ca
-  80 g/mq
-  300/300 



PRODOTTO  
  
 ITALIANO

SHOPPERS IN  
 CARTA KRAFT  
 BIANCA

PG068

PG069

PG070

PG066

PG067





## Shoppers in carta bianca

carta kraft bianca  
 maniglia piatta  
 soffietto

### PG066

portata 12 kg







-  45x48x15 cm ca
-  110 g/mq
-  250/250  SE

### PG067

portata 10 kg







-  32x43x17 cm ca
-  100 g/mq
-  250/250  SE

### PG068

portata 6 kg







-  26x39x16 cm ca
-  90 g/mq
-  250/250  SE

### PG069

portata 6 kg







-  22x29x10 cm ca
-  90 g/mq
-  300/300  SE

### PG070

portata 6 kg



-  19x24x7 cm ca
-  80 g/mq
-  300/300  SE



Maniglia piatta  
 in tinta

PRODOTTO  
  
 ITALIANO

SHOPPERS IN  
**CARTA AVANA  
 RICICLATA**

PG075

PG077

PG079

PG071

PG073



Maniglia piatta  
 in tinta





## Shoppers in colore naturale

carta avana riciclata  
 maniglia piatta  
 soffiato

### PG071

portata 12 kg







-  45x48x15 cm ca
-  120 g/mq
-  250/250  SE

### PG073

portata 10 kg







-  32x43x17 cm ca
-  90 g/mq
-  250/250  SE

### PG075

portata 6 kg







-  26x39x14 cm ca
-  90 g/mq
-  250/250  SE

### PG077

portata 6 kg







-  22x29x10 cm ca
-  80 g/mq
-  300/300  SE

### PG079

portata 6 kg



-  19x24x7 cm ca
-  80 g/mq
-  300/300  SE

## Shoppers per bottiglie in carta avana

shopper con soffietto  
maniglia ritorta  
carta avana riciclata  
portata 3 kg

### PG018 COLOR



- 14x8,5x39,5 cm ca
- 100 g/mq
- 300/300 SE

### PG020 NATURAL



- 14x8,5x39,5 cm ca
- 100 g/mq
- 300/300 SE



PG020NA

PRODOTTO  
ITALIANO



PG018BL



BO



NE



VE

## Shoppers per bottiglie in carta avana

PRODOTTO  
ITALIANO

shopper con soffietto  
maniglia ritorta  
carta avana  
capienza 2 bottiglie  
portata 9 kg

### PG016 COLOR



- 14x8x39 cm ca
- 100 g/mq
- 300/300 SE

### PG021 NATURAL



- 14x8x39 cm ca
- 100 g/mq
- 300/300 SE



PG021NA



NE

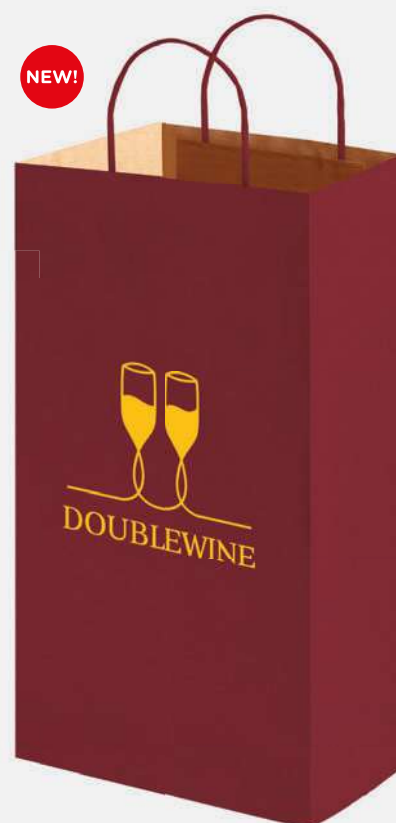

PG016BO





**PG019 COMPACT TAKE AWAY**

shopper con soffietto, carta bianca  
maniglia piatta, portata 5 kg



- 📏 26x16x31 cm ca
- 📐 90 g/mq
- 📦 250/250 🇪🇺 SE

**PRODOTTO**  
  
**ITALIANO**



BI

**PG023 WHITE TAKE AWAY**

shopper con soffietto, maniglia piatta  
carta kraft bianca, portata 5 kg

**PRODOTTO**  
  
**ITALIANO**



- 📏 32x22x33 cm ca
- 📐 90 g/mq
- 📦 300/300 🇪🇺 SE



NE



BI

SHOPPERS TAKE AWAY  
**FORMATO LARGE**

**PG025 COMPACT TAKE AWAY**

shopper con soffietto, carta avana  
maniglia piatta, portata 5 kg



26x16x31 cm ca

90 g/mq

250/250 SE

PRODOTTO



ITALIANO



NA

**PG022 TAKE AWAY**

shopper con soffietto, maniglia piatta  
carta avana riciclata, portata 5 kg



32x22x33 cm ca

90 g/mq

300/300 SE

PRODOTTO



ITALIANO



NA



SHOPPERS TAKE AWAY  
**FORMATO LARGE**

**PG088 CARRY**

carrello spesa in poliestere 600D  
struttura e ruote richiudibili  
chiusure laterali in velcro



- ☑️ aperta: 33x56x14,5 cm ca
- ☑️ chiusa: 33x20 cm ca
- 📦 1/36 🏠 SE TR



RY



INGOMBRO  
MINIMO

struttura e ruote richiudibili

RO



## Shoppers maxi in polipropilene

soffietto, bottone  
manici in nylon



### PG091 EBE



43x45x24 cm ca  
10/100 SE



AR: PG093



BI: PG091 - PG093

### PG093 ARES



35x34,5x22 cm ca  
10/100 SE



BL: PG091 - PG093



RO: PG091 - PG093



VL: PG091 - PG093

Shoppers con soggetti  
in polipropilene



CS

### PG094 BOX

borsa shopping in polipropilene  
soffietto, bottone, manici in nylon



35x34,5x22 cm ca

10/100 SE



CG



FV



MF

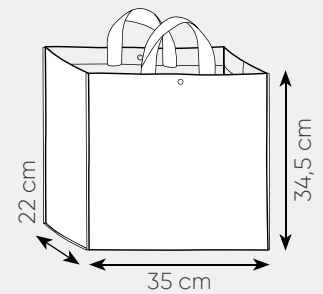

AR



BI



BL



RO



VL

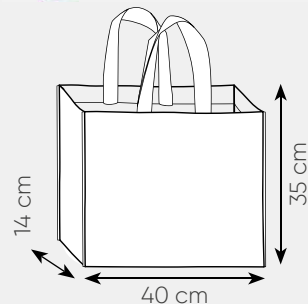

### PG095 REINA

borsa shopping in polipropilene, soffietto, manici lunghi



40x35x14 cm ca

25/100 SE



NEW!



VE

### PJ100 FREEGO

zaino termico in poliestere 600D e alluminio  
chiusura con zip, spallacci imbottiti regolabili



25x41,5x17 cm ca  
1/25 SE



6h



6h



13lt

retro con  
spallacci



RO



NEW!

AR



BL



NEW!

NE



RY

## MAXI CAPIENZA IDEALE PER LA SPESA

NEW!



## EXTRA CAPIENTE E FACILE DA TRASPORTARE

**EXTRA CAPIENTE:** perfetta per contenere tutto ciò di cui hai bisogno per una gita con la famiglia, oppure per mantenere al fresco la tua spesa.

**FACILE DA TRASPORTARE:** nonostante la grande capienza, la tracolla da spalla la rende semplice e leggera da trasportare.

**MATERIALI DI QUALITÀ:** l'esterno di questa borsa è realizzato in nylon altamente resistente. All'interno troviamo uno strato di PEVA che permette di isolare cibo e bevande dalla temperatura esterna per svariate ore



rivestimento interno in PEVA

### PJ102 BIGGY

borsa termica in poliester 210D  
interno refrigerante in PEVA  
zip di chiusura, manici, tracolla



53x38x19 cm ca

1/25 SE



8h



8h



35lt

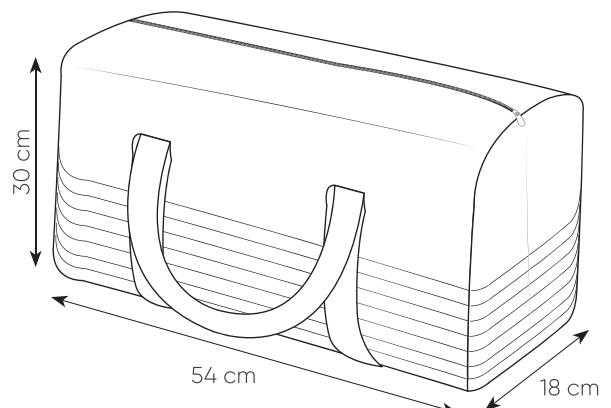



WR

**PJ103 SVEZIA**

borsa frigo, polipropilene e alluminio, chiusura con zip



38x39x19 cm ca

5/40 SE SU (BASE BI)



RO

RY

VL



WB

WG



BI

BL

GI

NE

RY

VL

RO



**PJ105 FROZEN**

sacca termica in poliestere 210D e alluminio tasca frontale, doppia corda di chiusura



32x42 cm ca

10/100 SE SU(BI) TR







**PJ104** FRISK

borsa frigo in tnt, manici corti, chiusura con zip



33x18x17 cm ca  
1/100 SE



BL



NE



RO



VL

**PJ106** MINI FRISK

borsa frigo in tnt, tracolla, chiusura con zip



20x14x14 cm ca  
1/200 SE



BL



NE



RY



VL

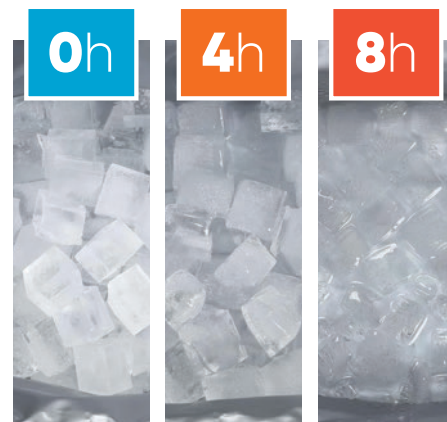

## INTERNO **WATERPROOF** E GRANDE CAPIENZA

**INTERNO IN PEVA: 100%** che rende l'interno della borsa frigo waterproof, mantiene il cibo caldo e le bevande fresche.

**ISOLAMENTO TERMICO AVANZATO:** che mantiene il cibo e le bevande a temperature ideali per diverse ore.

**IDEALE PER ESCURSIONI E SPIAGGIA:** La borsa termica è dotata di una tracolla regolabile e comoda da trasportare ovunque tu vada.



AR



BL



RY



VL



### PJ107 BAHIA

borsa frigo waterproof in poliestere 600D tasca frontale con zip, chiusura con zip manici e tracolla regolabile, capacità 10 litri



30x24x18 cm ca  
1/4 SE

**PJ108 IPANEMA**

borsa frigo in poliestere 600D,  
tasca frontale, tracolla regolabile,  
chiusura con zip, capacità 7 litri



22x24x17 cm ca  
1/50 SE



6h



6h



7lt



## VERSATILE E COMPATTA

**ALTAMENTE RESISTENTE:** realizzata in poliestere 600d altamente resistente e facile da pulire. La fodera interna è realizzata in fogli di alluminio.

**PIEGHEVOLE:** una volta utilizzata può essere facilmente piegata e riposta nella borsa di tutti i giorni.

**IDEALE PER L'UFFICIO, VIAGGIO IN AUTO E PICNIC:** la borsa termica è dotata di una tracolla regolabile e comoda da trasportare ovunque tu vada.

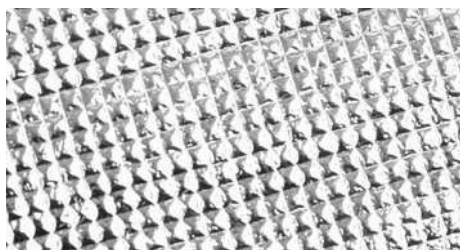

rivestimento interno in alluminio



BI



RO



RY



VL



## PRATICA, RESISTENTE ED ECOLOGICA

**ISOLAMENTO TERMICO AVANZATO:** che mantiene il cibo caldo e le bevande fresche e a temperature ideali per diverse ore.

**IDEALE PER L'UFFICIO, VIAGGIO IN AUTO E PICNIC:** la borsa termica è dotata di una tracolla regolabile e comoda da trasportare ovunque tu vada tutti i giorni. Utile anche come portavivande.

**FACILE DA PULIRE:** grazie al rivestimento interno antimacchia che previene la formazione di odori e la crescita di batteri.

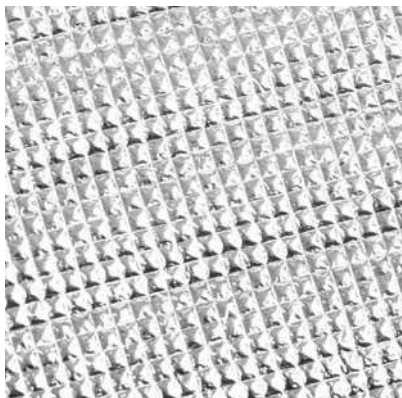

rivestimento interno in alluminio



ampia tasca frontale

### PJ109 REUSE

borsa frigo in RPET, tracolla regolabile zip di chiusura in metallo, tasca frontale capacità 4 litri



25x15x15 cm ca

1/50 SE



NE



GR

**PJ112 PARIS**

borsa frigo in poliestere, effetto melange, manici corti, chiusura con zip, capacità 8 litri



28x22x19 cm ca

1/50 SE



6h



6h



8lt

## MANEGGEVOLE E **ALLA MODA**

**DIMENSIONI PERFETTE:** grazie al suo design minimalista di dimensione compatte, questa borsa è perfetta per l'ufficio, scuola e gite brevi.

**IDEALE PER PRANZI FUORI CASA :** leggera e portatile, appositamente progettata con una comoda e resistente maniglia imbottita

**MATERIALI DI QUALITA':** progettata con rivestimento isolante in alluminio di alta qualità, che può mantenere il cibo ad alta o bassa temperatura per diverse ore.

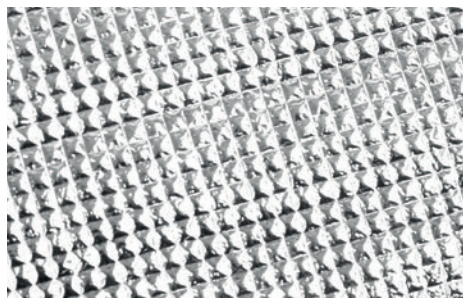

rivestimento interno in alluminio



BL

NE

## BORSA TERMICA EFFETTO MELANGE



BL

## PRATICA E COMPATTA

**DIMENSIONI PERFETTE:** grazie al suo design minimalista di dimensione compatte, questa borsa è perfetta per l'ufficio, scuola e gite brevi.

**FACILE DA TRASPORTARE:** leggera e portatile, appositamente progettata con una comoda e resistente maniglia.

**MATERIALI PREMIUM:** progettata con rivestimento isolante in alluminio di alta qualità, che può mantenere il cibo ad alta o bassa temperatura per diverse ore. l'esterno è realizzato con poliestere 600d oxford facile da pulire.

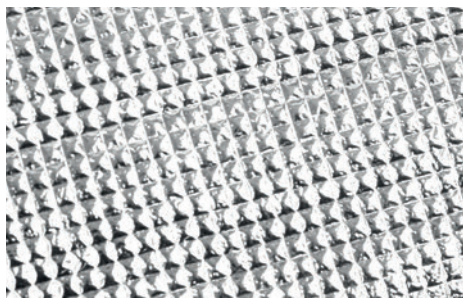

rivestimento interno in alluminio

## PJ113 WAY

borsa frigo in poliestere, effetto melange manici corti, chiusura in velcro, capacità 8 litri



24x27x14 cm ca

1/50 SE



GR



NE

**PG106 TRACY**

borsa shopping in poliestere 210D  
piegabile in pochette, manici integrati



- aperta 42x56x15 cm ca     chiusa 57x56 cm ca  
 pochette 14,5x9,5 cm ca     50/200     SE SU(BI)



AZ



Shopper ripiegabile  
in pochette



AR



BI



BL



GI



RO



VE

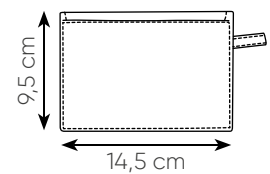
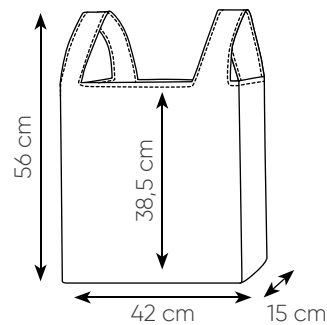

### PG108 SAMMY

borsa shopping in poliestere 210D  
piegabile in pochette, manici integrati



📏 aperta 40x57x7,5 cm ca   📏 pochette 16x15 cm ca  
📦 50/300   🏷️ SE SU(BI)



VE



Shopper ripiegabile  
in pochette



AR



AZ



BI



BL



GI



RO

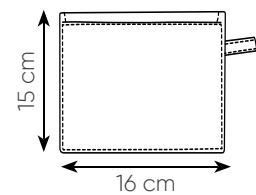
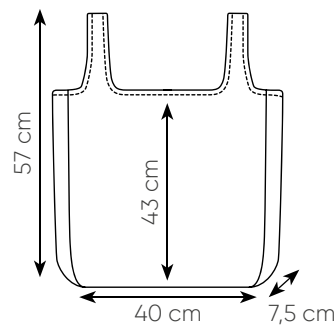



**PG110 PERCY**

borsa shopping in poliestere 190T  
ripiegabile con elastico, manici lunghi



38x42 cm ca

10/300 SE SU(BI)



Shopper ripiegabile  
con chiusura con elastico

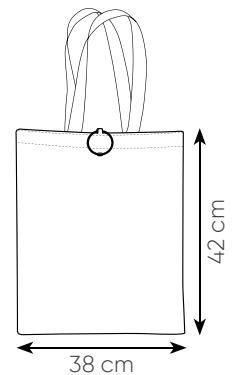



RPET  
ZERO  
SPRECHI

NEW!

Shopper ripiegabile  
in pochette integrata  
dim. 13x13 cm ca



VE



BL



AZ



BI



NE



RO

**PG468 CYCLE**

borsa shopping in RPET 210, manici corti, soffietto



38x40x9 cm ca 50/400

SE SU(BI)

**PG133 ECOBAG 3**

borsa shopping tnt rpet 50%, soffietto, manici corti  
rifiniture termosaldate, extra resistente, portata 18kg



50x40x15 cm ca

10/200 SE



BI



BL



NE



VE

MADE IN  
EUROPE



RPET  
ZERO  
SPRECHI



RO



# Shoppers in TNT RPET 50%

soffietto, portata 40kg  
rifiniture termosaldate  
extra resistente

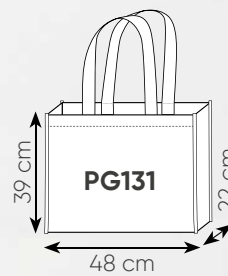

TNT RPET



PG131RO

TNT RPET



PG132EC

## PG131 ECOBAG 1

manici lunghi



48x39x22 cm ca  
10/50 SE

MADE IN EUROPE



## PG132 ECOBAG 2

manici corti



40x40x20 cm ca  
10/130 SE



BI: PG131 - PG132



BL: PG131 - PG132



NE: PG131 - PG132



RO: PG131 - PG132



VE: PG131 - PG132



RY



**RPET**  
ZERO  
SPRECHI

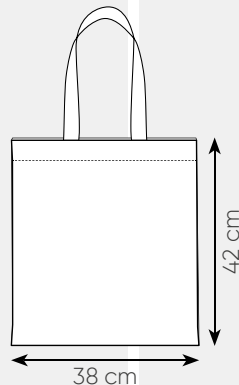

AZ

**PG462 ATLAS**

borsa shopping in 210 rpet, manici lunghi



38x42 cm ca  
50/200 SE



AR



BI



BL



GI



NE



RO



VE

**PG463 MAREA**

borsa shopping in tnt rpet, manici lunghi



38x42 cm ca  
50/200 SE



BI



BL



NE



RO



VE



VL



**RPET**  
ZERO  
SPRECHI

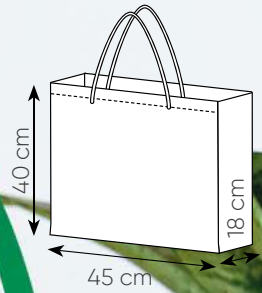

NEW!

TNT  
RPET



PG465RY

NEW!

TNT  
RPET



PG466VE

**PG465 CARIBE**

borsa shopping in tnt rpet, manici lunghi, soffietto



38x42x8 cm ca  
50/200 SE



**PG466 MOKI**

borsa shopping in tnt rpet, manici lunghi, soffietto



45x40x18 cm ca  
50/200 SE





**PG129 ILEX**

borsa shopping  
polietilene  
manici lunghi  
rifiniture cucite



38x42 cm ca  
10/400 SE SU TR



**SPECIALE  
SUBLIMAZIONE**

La shopper PG129, realizzata interamente in polietilene, è stata pensata per ottenere il miglior risultato con la tecnica di stampa sublimatica



**PG143 SHOP BOX**

borsa shopping in tnt, chiusura con zip  
tasca frontale con velcro, manici corti  
rifiniture cucite



40x36x20 cm ca  
10/200 SE



richiudibile con zip



RO



BI



NE



# SHOPPERS IN TNT LAMINATO

manici lunghi, soffietto rifiniture termosaldate



PG135AZ



PG134VL

## PG134 CLEAR



40x35x12 cm ca  
10/200 SE



## PG135 ALIDA



26x32x9 cm ca  
50/250 SE



AR: PG134 - PG135



AZ: PG135



BI: PG134 - PG135



BL: PG134 - PG135



GI: PG135



NE: PG134 - PG135

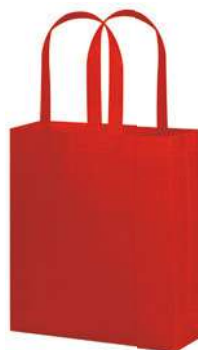

RO: PG134 - PG135



VE: PG135



VL: PG134 - PG135

# SHOPPERS IN TNT GLITTER

manici corti, soffietto rifiniture termosaldate colori glitterati



PG138OR



PG139RO

## PG138 GLITTER 1



23x25x10 cm ca  
50/200 SE



## PG139 GLITTER 2



40x35x12 cm ca  
50/200 SE



BL: PG138



OR: PG138 - PG139



RO: PG138 - PG139



SI: PG138 - PG139



## SHOPPING BAG FORMATO MAXI

Ideale per negozi di abbigliamento e sartoria.



TNT

NEW!



### PG140 RICO

borsa shopping in tnt  
manici corti  
rifiniture cucite  
soffietto



60x45x20 cm ca  
20/100 SE

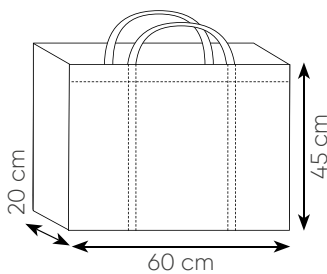

### PG145 MARGARET

borsa shopping in tnt, soffietto  
manici corti, rifiniture termosaldate



42x32x10 cm ca

10/200 SE



RO



AR



BI



BL



NE



RY



VE



VL

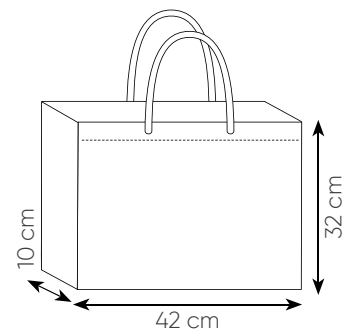

200

Shoppers in tnt  
**con manici forati per espositori**

soffietto  
 rifiniture termosaldate



**PG146** CATEGORY B



31x56x17 cm ca  
 10/400 SE



**PG148** CATEGORY S



22x44x14 cm ca  
 10/500 SE

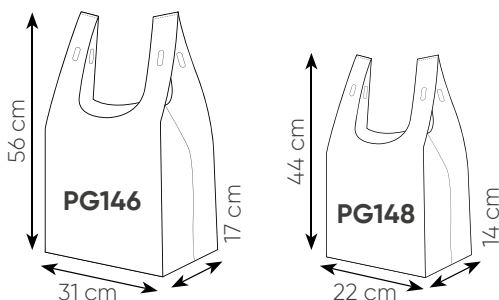



**PG147 SAVANA**

borsa shopping in tnt, colore naturale  
manici lunghi colorati



45x40x18 cm ca

25/100 SE

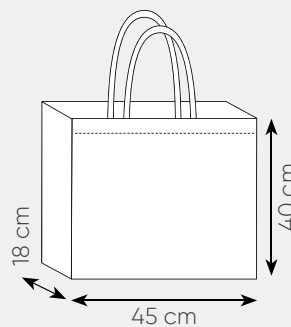

**PG150 VANITY**

borsa shopping in tnt, manici lunghi, rifiniture cucite



42x42 cm ca

10/200 SE



AR



BI



BL



GI



NE



RO



VE



### PG151 DIVINE

borsa shopping in tnt, soffietto, cuciture termiche



aperta: 31x32x20 cm ca chiusa: 51x32 cm ca  
 10/200 SE



BI



BL



NE



RO



VE

aperta:  
31x32x20 cm ca

chiusa:  
51x32 cm ca

### PH265 PSI

borsa shopping in tnt, cuciture termiche



32x42 cm ca  
 20/400 SE



BI



BL



NE



RY



RO



VE

**PG152 DOUBLE**

borsa shopping in tnt, rifiniture cucite, doppi manici lunghi e corti, soffietto



40x50x10 cm ca

10/100 SE

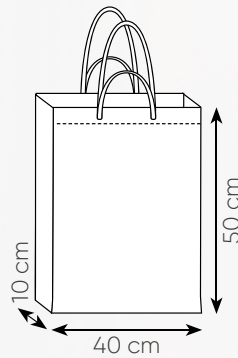

RY



AR



BI



BL



GI



NE



RO



VL

**PG153** DEMETRA

borsa shopping in tnt, soffietto, rifiniture termosaldate, manici lunghi



36x40x9 cm ca

10/200 SE

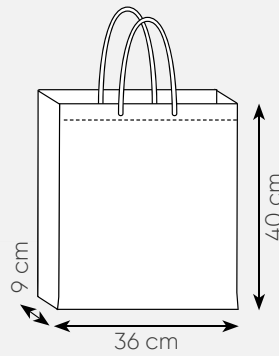

GI



AR



BI



BL



NE



RO



RY



VL

### PG154 MADISON

borsa shopping in tnt, rifiniture cucite, manici corti, soffietto



45x45x14 cm ca

10/200 SE



VE



AR



BI



BL



GI

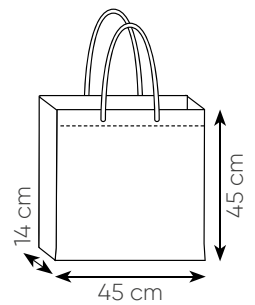

GR



NE



RO



RY



VL



### PG156 CELEBRITY

borsa shopping in tnt, soffietto, rifiniture cucite, manici lunghi



38x42x10 cm ca

10/150 SE



VL



AR



BI



BL

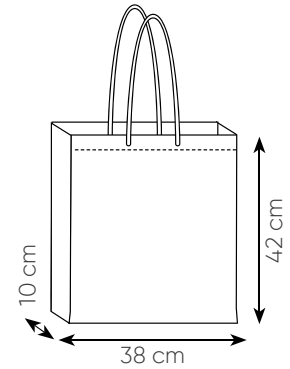

GI



NE



RO



RY

### PG157 AISHA

borsa shopping in tnt, rifiniture termosaldate, manici lunghi



36x40 cm ca  
10/200 SE



RY



AR



AZ



BI



BL



EC



FX



GI



GR



MA



NE



RO



RS



VE



VL



VS

**PG158 GIFT**

borsa shopping in tnt, manici lunghi  
fondo con soffietto, fori per nastro  
(non incluso) rifiniture termosaldate



50x40x11 cm ca  
10/200 SE

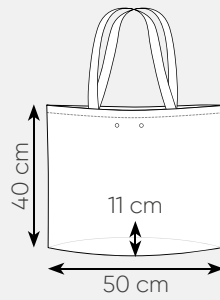

AR



BI



BL



BO



NE



RO



RY



VE



VL

**PG161 COLORES**

borsa shopping in tnt, rifiniture termosaldate, manici lunghi, soffietto



38x42x9 cm ca

10/200 SE



AR



GI

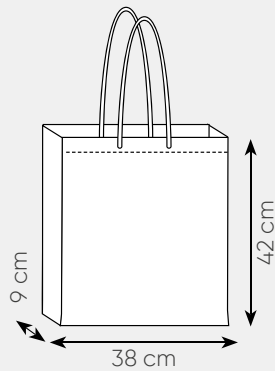

NE



RO



VE



BL

**PG159 URANUS**

borsa shopping in tnt, rifiniture termosaldate, manici lunghi



38x42 cm ca

10/200 SE



BY



EB



RW



RY



WA



WB



WG



WN



WR



WV

VE



# PG160 MUSA

borsa shopping in tnt, manici lunghi, rifiniture cucite



38x42 cm ca  
10/200 SE



AZ



AR



BI



BL



EC



FX



GI



MA



NE



RO



RY



VE



VL

### PG162 FLORA

borsa shopping in tnt, rifiniture cucite, manici corti



38x42 cm ca

10/200 SE



AR



BI



BL



GI



MA



NE



RO



RS



RY



VE



VI



VL

# Shoppers in tnt

manici lunghi, soffietto  
rifiniture cucite

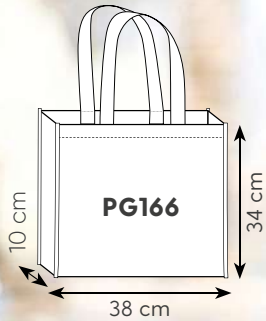

PG168VE



PG166RO

## PG166 STELLA



38x34x10 cm ca  
10/200 SE



AR



BI



BL



GI

## PG168 STELLINA



23x25x10 cm ca  
10/200 SE



NE



RO



RY



VE

Shoppers in tnt  
soffietto, rifiniture termosaldate

TNT



PG167AZ

NEW!

TNT



PG171RO

PG167 ANDRA

manici corti



25x23x10 cm ca  
50/400 SE

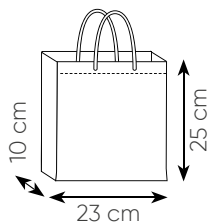

PG171 ANDRA MAXI

manici lunghi



50x40x12 cm ca  
25/100 SE

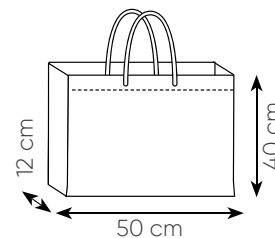



# Shoppers in tnt

soffietto, manici lunghi  
rifiniture termosaldate



## PG174 DAFNE BIG



38x34x12 cm ca  
50/250 SE

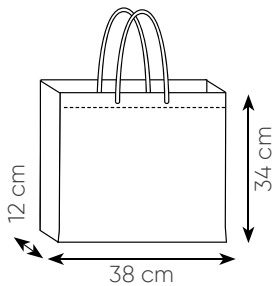

## PG176 DAFNE



35x25x10 cm ca  
10/200 SE

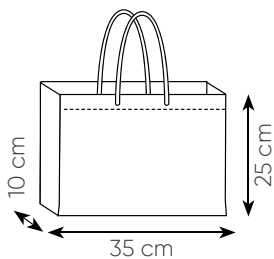

**PG163 BLOOM**

borsa shopping in tnt, richiudibile con bottone, manici corti, rifiniture cucite



aperta: 34x38,5x20 cm ca    chiusa: 19x20 cm ca  
 10/100    SE



Shopper ripiegabile richiudibile con bottone



AR



BI



BL



RO



RY

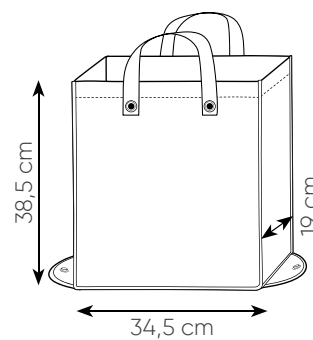

**PG173 FEDRA**

borsa shopping in tnt, richiudibile con bottone, manici corti, rifiniture cucite



aperta: 32x42x13 cm ca    chiusa: 15x13 cm ca  
 10/200    SE



RY



AR



BI



BL



GI



NE



RO



VE

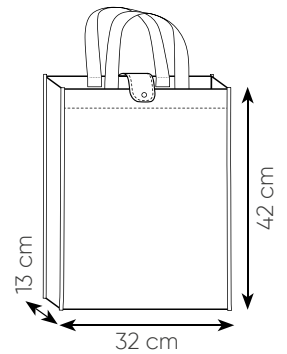

**PG175 DAFNE**

borsa shopping in tnt richiudibile con velcro, manici lunghi, rifiniture cucite



aperta 38x42 cm ca    chiusa 18x11 cm ca  
 10/200    SE



RO



Shopper ripiegabile e richiudibile con velcro

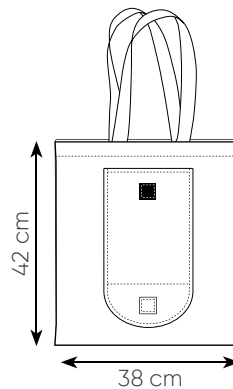



**PG165 FAIR**

tracolla in tnt, rifiniture cucite, spalaccio personalizzabile



30x38,5x8,5 cm ca

10/200 SE



RY



AR



GR



EC



RO

**PG170 BAG T**

sacca multiuso in tnt  
doppia corda, rifiniture cucite



36x41 cm ca

10/200 SE



AR



BI



NE



RO



RY



VE



BL



GI

Sacchetti  
multiuso in TNT  
**termosaldati**  
**70 grammi**



**PG401 BIJOU**



10x14 cm ca  
100/100 SE

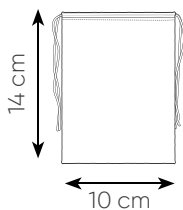

**PG402 PARCELLE**



15x20 cm ca  
50/1000 SE

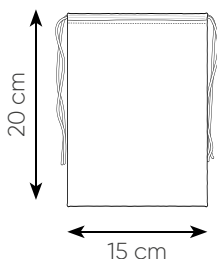

# SACCHETTI IN COTONE



doppia corda di chiusura  
colore naturale



PG191EC

PG192EC

PG183EC

PG193EC

## PG193 MIA



- 📏 40x50 cm ca
- 📦 25/150
- 📏 DI SE TR
- 📏 120 g/mq

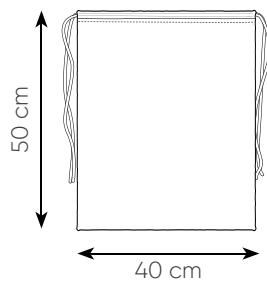

## PG192 LIA



- 📏 25x30 cm ca
- 📦 50/250
- 📏 DI SE TR
- 📏 120 g/mq

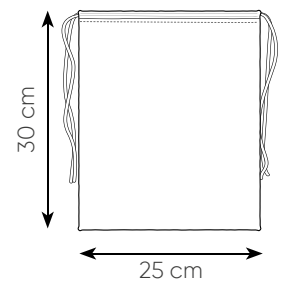

## PG183 ZOE



- 📏 30x40 cm ca
- 📦 10/200
- 📏 DI SE TR
- 📏 135 g/mq

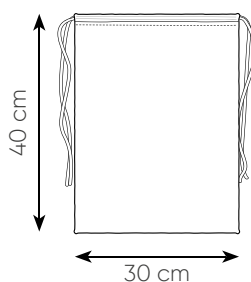

## PG191 SIA



- 📏 10x14 cm ca
- 📦 100/500
- 📏 DI SE TR
- 📏 120 g/mq

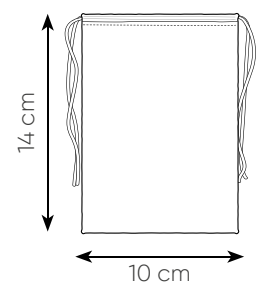

SACCA  
ZAINO  
IN COTONE



doppia corda di chiusura

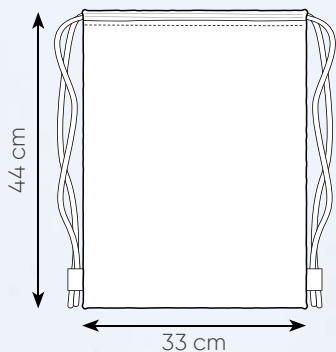

RO

**PG189** HELLAS COLOR

sacca zaino in cotone  
doppia corda di chiusura  
rifiniture cucite



- ☑ 33x44 cm ca
- ☑ 10/200
- ☑ 100 g/mq
- ☑ DI (BI-EC) SE TR



AR



BI



BL



EC



NE



RY



VL



# SACCA ZAINO IN COTONE



doppia corda di chiusura  
colore naturale

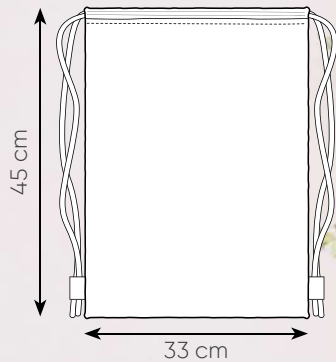

RO

## PG197 HELLAS

sacca zaino in cotone, doppia corda in cotone, colore naturale, rifiniture cucite



33x45 cm ca 130 g/mq  
10/200 DI SE TR



AR

EC

NE

RY

# SACCA ZAINO IN COTONE RICICLATO

doppia corda di chiusura



VE

## PG179 MELISSA

sacca zaino  
cotone riciclato  
doppia corda di chiusura  
rifiniture cucite



- 33x45 cm ca
- 150 g/mq
- 10/200 SE TR

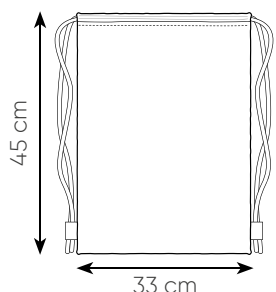



# SHOPPERS IN COTONE RICICLATO

manici lunghi

## PG447 LISA



38x42 cm ca 10/100  
190 g/mq SE TR



**NEW!**

## PG177 ANNIE



38x42 cm ca 10/200  
150 g/mq SE TR



## PG437 LARA



38x42 cm ca 10/100  
280 g/mq SE TR



**NEW!**



AR:  
PG177 - PG447



BL:  
PG177



BO:  
PG177



EC:  
PG177 - PG437 - PG447



GI:  
PG177 - PG447



NE:  
PG177 - PG447



RO:  
PG177 - PG447



RS:  
PG177



RY:  
PG177 - PG437 - PG447



VE:  
PG177 - PG437



VL:  
PG177 - PG447

# SHOPPER IN COTONE RICICLATO

NEW!

150  
gsm

COTONE  
RICICLATO

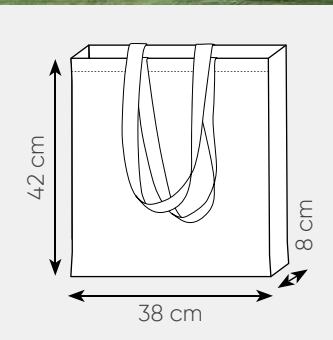

VL



## PG477 ANDY

shopper in cotone riciclato  
soffietto, manici lunghi



- 38x42x8 cm ca
- 150 g/mq
- 10/200
- SE TR



AR



BL



EC



GI



NE



RO



RY

**PG433 MINA**

borsa shopping in cotone organico  
manici lunghi, rifiniture cucite, colore naturale



32x24x10 cm ca 120 g/mq  
50/250 DI SE TR



NEW!



SHOPPERS  
IN COTONE  
ORGANICO

**PG407 DAISY**

shoppers in cotone organico  
manici lunghi, soffietto, colore naturale



50x38x15 cm ca 120 g/mq  
50/250 SE TR



NEW!

**PG196 DENNIS**

borsa shopping in cotone organico  
manici lunghi, rifiniture cucite, colore naturale



38x42 cm ca 220 g/mq  
10/100 DI SE TR



NEW!

**PG198 VIOLET**

borsa shopping in cotone organico  
manici lunghi, rifiniture cucite, colore naturale



38x42 cm ca 140 g/mq  
10/250 DI SE TR





**PG426 CLEIA**

shoppers in cotone organico  
manici lunghi



- 38x42 cm ca
- 140 g/mq
- 10/200 SE TR



**PG436 RAPHY**

shoppers in cotone organico  
manici lunghi, soffietto



- 50x38x15 cm ca
- 120 g/mq
- 10/250 SE TR

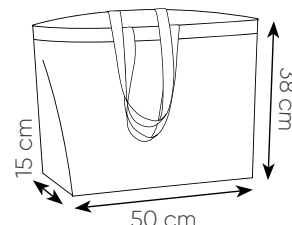

BI



BL



NE



RO



BI



BL



NE



RY



## SHOPPERS IN COTONE



manici lunghi, soffietto

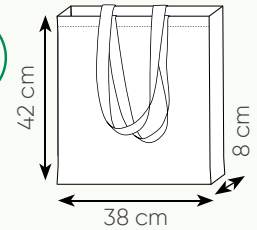

### PG422 GUSSET 140

shopper in cotone organico



38x42x8 cm ca 140 g/mq

10/90 SE TR



### PG424 GUSSET

shopper in cotone canvas



38x42x8 cm ca 180 g/mq

10/100 SE TR



### PG423 NEREA

shoppers in cotone canvas  
manici lunghi, soffietto



38x42x8 cm ca 280 g/mq

10/100 SE TR

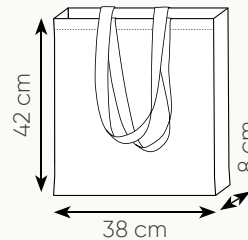

COTONE  
CANVAS



AR



BI



BL



GI



NE



RO



VE

# SHOPPER IN COTONE CANVAS

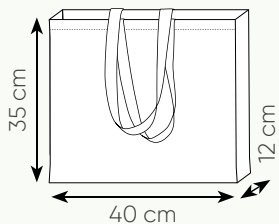

## PG450 REBECCA

borsa in cotone canvas  
soffietto, manici lunghi



- 40x35x12cm ca
- 200 g/mq
- 10/100 SE TR



Tessuto cotone canvas con etichetta



NEW!



RO



## PG451 CLOE

borsa in cotone canvas, soffietto, manici lunghi



- 40x35x12cm ca
- 200 g/mq
- 10/100 SE TR



AR



BI



BL



GI



NE



RY



VL

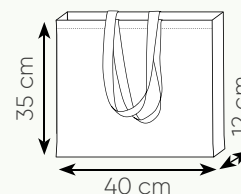



# SHOPPER IN COTONE CANVAS RICICLATO



## PG487 NANCY

borsa in cotone canvas riciclato  
soffietto, manici lunghi



- 50x37x15 cm ca
- 280 g/mq
- 10/100 SE TR

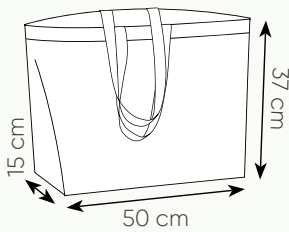

## PG499 ANDREW

borsa in cotone canvas, soffietto  
manici lunghi, tasca frontale



- 59x40x28 cm ca
- 280 g/mq
- 10/50 SE TR



BL



RO



BORSE IN  
**COTONE  
CANVAS**



NEW!

NEW!



PG455BL



PG456RO

**PG455** JEANNE

borsa in cotone canvas  
soffietto, manici lunghi colorati



- ☑ 50x38x18 cm ca
- ☑ 280 g/mq
- ☑ 10/50 ☑ SE TR

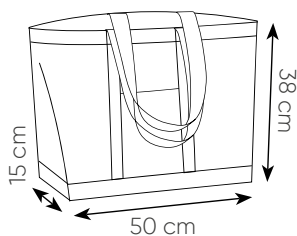

AZ



NE



RO



tasca anteriore

**PG456** SANDY

borsa in cotone canvas  
manici lunghi, soffietto



- ☑ 55x39x15 cm ca
- ☑ 280 g/mq
- ☑ 10/200 ☑ SE TR

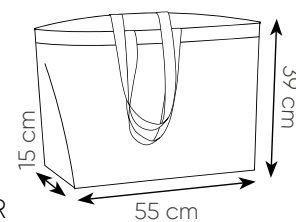

BL



EC



BORSE IN  
COTONE  
E JUTA



PG245EC



PG242EC

**PG245** MAYA

borsa in cotone laminato e juta soffiato, manici lunghi



- 48x35x15 cm ca
- 220 g/mq 10/100
- DI SE TR



BORSA IN  
COTONE  
LAMINATO  
E JUTA

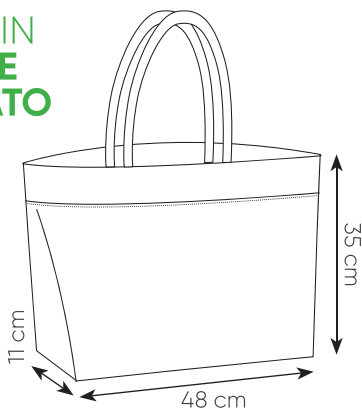

tasca anteriore

**PG242** JUDI

borsa in juta e cotone manici lunghi imbottiti tasca frontale in cotone



- 45x35x11 cm ca
- 10/50
- DI SE TR

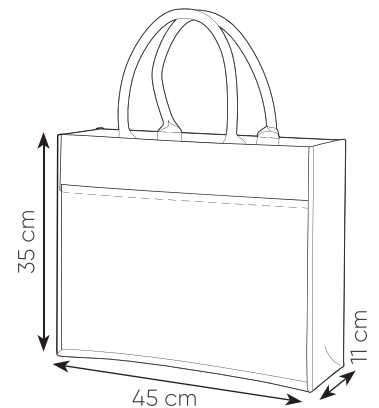

**PG241 JAMI**

sacca zaino in juta e cotone, tasca frontale in cotone  
chiusura con corda



23x45 cm ca

10/100 SE TR



SACCA IN  
JUTA E  
COTONE

**PG246 KATY**

sacca zaino in cotone e juta, doppia corda di chiusura



38x42 cm ca 150 g/mq

10/100 SE TR



SACCA IN  
COTONE  
E JUTA



**PG248 JAMES**

cotone laminato e juta, soffietto, manici lunghi



48x35x15 cm ca 200 g/mq  
10/100 DI SE TR

**PG244 KARA**borsa shopping cotone e juta  
manici lunghi, colore naturale

38x42 cm ca  
150 g/mq  
10/100  
DI SE TR



**SHOPPER  
IN COTONE  
E JUTA**





PG440EC



PG181EC

**PG440 NINA**

shoppers in cotone  
colore naturale  
manici lunghi, soffietto



- 50x38x15 cm ca
- 135 g/mq
- 10/200

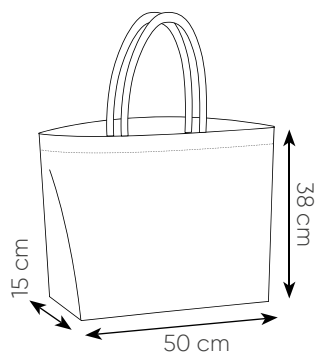

SHOPPERS  
IN COTONE



Etichetta in cotone

**PG181 CORDELIA**

shoppers in cotone extrapesante  
manici lunghi, soffietto  
rifiniture cucite



- 50x35x16 cm ca
- 320 g/mq
- 10/100

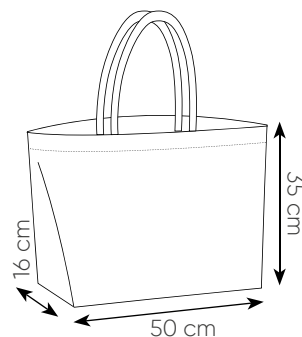

# SHOPPERS IN COTONE



manici lunghi, soffietto



NEW!



PG441RY



NEW!



PG453RO

## PG453 BETTY



- 40x30x10 cm ca
- 120 g/mq
- 50/250
- DI SE TR

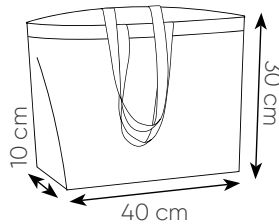

## PG441 CALIPSO



- 50x38x15 cm ca
- 135 g/mq
- 10/200
- DI SE TR

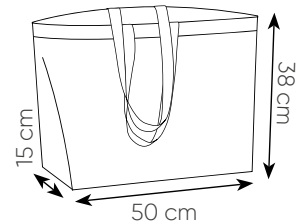

BI



BL



BI



BL



NE



RY



NE



RO

**PG452 TERNURA**

borsa shopping in 100% cotone  
manici lunghi, rifiniture cucite  
colore naturale



40x30x10 cm ca 120 g/mq  
50/250 SE TR



SHOPPER  
IN COTONE



etichetta in cotone

**PG216 VIRGINIA**

borsa shopping in cotone, manici lunghi  
colore naturale, rifiniture cucite



40x50 cm ca 130 g/mq  
10/100 DI SE TR



SHOPPER  
IN COTONE





**PG195 FRUITY**

borsa shopping in cotone, trama a rete  
manici lunghi, colore naturale, rifiniture cucite  
banda superiore personalizzabile



38x42x8 cm ca 140 g/mq  
10/100 DI SE TR



SHOPPER  
IN COTONE



etichetta in cotone



tessuto con trama a rete

**PG185 MISTY**

borsa shopping in cotone  
manici lunghi  
doppia corda  
rifiniture cucite



50x40 cm ca  
135 g/mq  
10/200  
DI SE TR



SHOPPER  
IN COTONE



## BORSE SHOPPING IN COTONE



manici lunghi, colore naturale  
dimensioni: 38x42 cm ca



Scegli la grammatura  
più adatta alle tue  
esigenze:



### PG199 LUXOR



38x42 cm ca 105 g/mq  
10/250 DI SE TR



### PG210 GIZA



38x42 cm ca 130 g/mq  
10/200 DI SE TR



### PG420 NIKKI



38x42 cm ca 180 g/mq  
10/200 SE TR



### PG186 DARLA



38x42 cm ca 220 g/mq  
10/200 DI SE TR



### PG182 MARIE



38x42 cm ca 280 g/mq  
10/100 DI SE TR



**BORSE SHOPPING  
IN COTONE**

colore naturale



**PG200 ALICIA**

manici corti



26x32 cm ca 120 g/mq  
10/200 DI SE TR



**PG206 CAIRO**

manici corti



38x42 cm ca 130 g/mq  
10/250 DI SE TR



**PG213 KANSAS**

manici lunghi



42x42 cm ca 130 g/mq  
50/250 DI SE TR



RO



# SHOPPERS IN COTONE



manici lunghi colorati  
colore naturale

## PG187 QUEENIE



38x42 cm ca 220 g/mq  
10/100 SE TR DI



## PG207 HURGADA



38x42 cm ca 130 g/mq  
10/250 SE TR DI



AR



AZ



BL



GI



NE



VE

# SHOPPER IN COTONE



manici corti colorati, colore naturale

## PG201 SCARLETT



- 26x32 cm ca
- 120 g/mq
- 10/200
- DI SE TR



GI



AR



AZ



BL



NE



RO



VE

### PG406 GRACE

borsa shopping in cotone  
manici corti, rifiniture cucite, soffiato



38x42 cm ca 130 g/mq  
10/250 DI SE TR



AZ



SHOPPER  
IN COTONE



BI



BL



GI



NE



RO



RY



VE

# SHOPPER IN COTONE

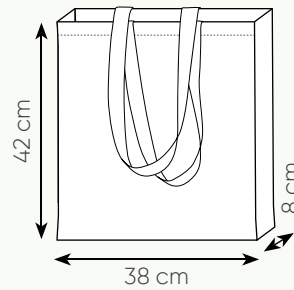

## PG194 SHELLEY

borsa shopping in cotone  
manici lunghi colorati  
soffietto, rifiniture cucite



38x42x8 cm ca 220 g/mq  
10/100 DI SE TR



RO



# SHOPPER IN COTONE



## PG202 ASSUAN

borsa shopping in cotone  
manici lunghi, rifiniture cucite  
soffietto, colore naturale



38x42x8 cm ca 220 g/mq  
10/100 DI (BI) SE TR

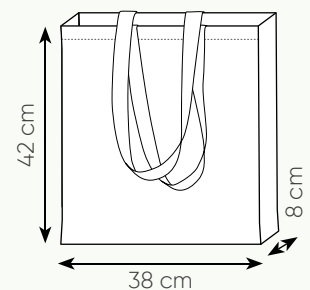

# SHOPPER IN COTONE



manici lunghi, soffietto



## PG203 MENFI



38x42x8 cm ca 220 g/mq  
10/90 DI (BI) SE TR



AR

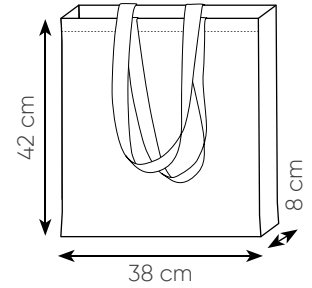

BI



BL



FX



GI



GR



NE



RO



RY



VE



VL



# SHOPPERS IN COTONE



manici lunghi, 38x42 cm ca



## PG421 CHARLES



38x42 cm ca 180 g/mq  
10/200 DI (BI) SE TR



**NEW!**

## PG211 SPRING



38x42 cm ca 130 g/mq  
10/200 DI (BI) SE TR



AR: PG211 - PG421



AZ: PG211



BI: PG211 - PG421



BL: PG211 - PG421



FX: PG211



GI: PG211 - PG421



GR: PG211 - PG421



NE: PG211 - PG421



RO: PG211 - PG421



RS: PG211



RY: PG211 - PG421



VE: PG211



VL: PG211 - PG421



VS: PG211

# SHOPPERS IN COTONE



manici lunghi, 38x42 cm ca

## PG184 MYRTLE



38x42 cm ca 280 g/mq  
10/100 DI (BI) SE TR



## PG188 CECILY



38x42 cm ca 220 g/mq  
10/100 DI (BI) SE TR



AR: PG184 - PG188



AZ: PG188



BI: PG184 - PG188



BL: PG184 - PG188



GI: PG184 - PG188



MA: PG188



NE: PG184 - PG188



RO: PG184 - PG188



RS: PG188



RY: PG188



VE: PG184 - PG188



VI: PG188



VL: PG184 - PG188





# SHOPPER IN COTONE



manici lunghi, soffietto

## PG214 GEORGIA



42x42 cm ca 130 g/mq  
50/250 DI SE TR



AR



AZ



BI



BL



GI



GR



MA



NE



RO



RS



RY



VE



VI



VL

06.

ZAINI,  
BORSE  
E SACCHE





tasca interna con zip



tasca antirapina nascosta sul retro

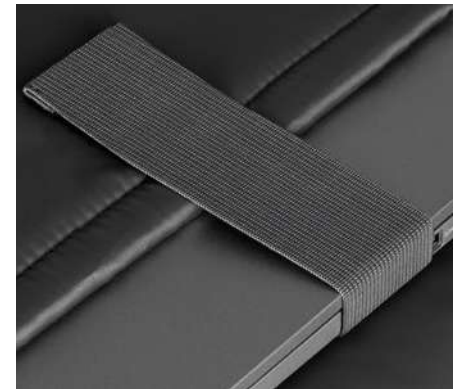

vano interno per laptop e tablet

## CA026 SHADOW

zaino in ecopelle con finiture cromate nere  
 doppio scomparto con zip  
 fascia per trolley sul retro  
 vano imbottito per pc e tablet fino a 15"  
 1 tasca anteriore con zip, 1 interna con zip  
 retro imbottito con tasca antitaccheggio  
 spallacci imbottiti con asola porta occhiali  
 borsa in tnt Cavallari Studio inclusa



30xh45x14 cm ca  
 1/10 SE



CAVALLARI  
STUDIO

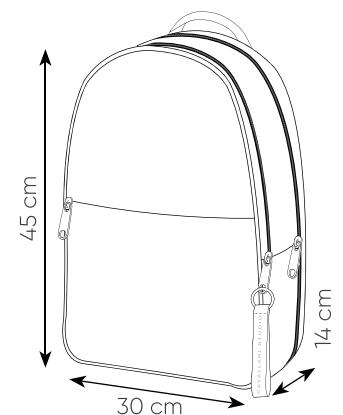



BL



connettore USB con cavo



fascia posteriore per trolley



vano interno per laptop e tablet

### CA031 YOUNG

zaino in poliestere 300D  
 tasca anteriore con zip  
 tasca imbottita per pc e tablet  
 tasche laterali in materiale traforato  
 vano 2 tasche e porta penne  
 connettore USB con cavo  
 retro e spallacci imbottiti  
 fascia per trolley sul retro  
 borsa in tnt Cavallari Studio inclusa



30x45x15 cm ca  
 1/25 SE



GR



NE

CAVALLARI  
 STUDIO

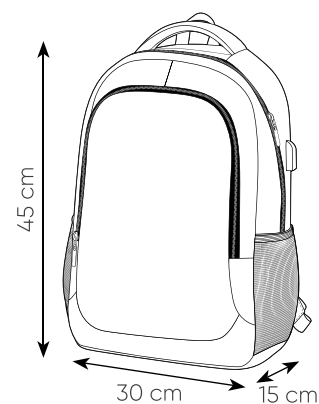



connettore USB integrato



cavo USB interno integrato

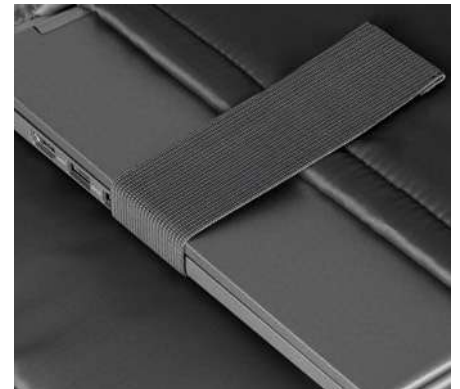

vano interno per laptop e tablet

## CA033 MAORI

zaino/cartella in poliestere 420D e PU  
 connettore USB con cavo integrato  
 fascia per trolley sul retro  
 tasca anteriore in ecopelle  
 interno 5 tasche e porta penne  
 spallacci removibili a scomparsa  
 secondo manico per uso borsa a mano  
 tasca interna imbottita per pc e tablet  
 borsa in tnt Cavallari Studio inclusa



32xh42x14 cm ca  
 1/25 SE



doppio uso:  
 zaino e  
 borsa a mano

CAVALLARI  
 STUDIO

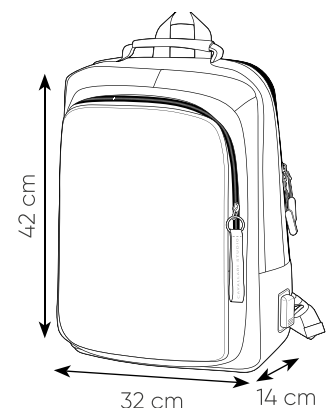



connettore USB integrato



tasca antirapina sul retro



vano interno per laptop e tablet

### CA035 BLOSSOM

zaino/cartella in poliestere 420D e PU  
 apertura completa, connettore USB  
 secondo manico per uso borsa a mano  
 tasca anteriore e laterale con zip  
 fascia per trolley sul retro  
 tasca interna imbottita per pc e tablet  
 7 tasche interne e p/penne  
 spallacci removibili a scomparsa  
 retro imbottito con tasca nascosta  
 borsa in tnt Cavallari Studio inclusa

struttura con  
 apertura  
 completa

doppio uso:  
 zaino e  
 borsa a mano



CAVALLARI  
 STUDIO



27x48x18 cm ca

1/20 SE





fascia posteriore per trolley



connettore USB integrato

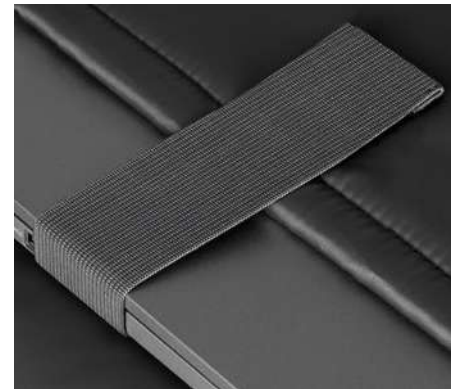

vano interno per laptop e tablet

**CA037 TRIP**

- zaino in poliestere 600D
- tasca anteriore con zip
- tasche laterali in materiale traforato
- vano 2 tasche e porta penne
- connessione USB
- tasca imbottita per portatile e tablet
- retro e spallacci imbottiti
- fascia per trolley sul retro
- borsa in tnt Cavallari Studio inclusa



31x46x12  
1/25 SE



GS

**CAVALLARI  
STUDIO**



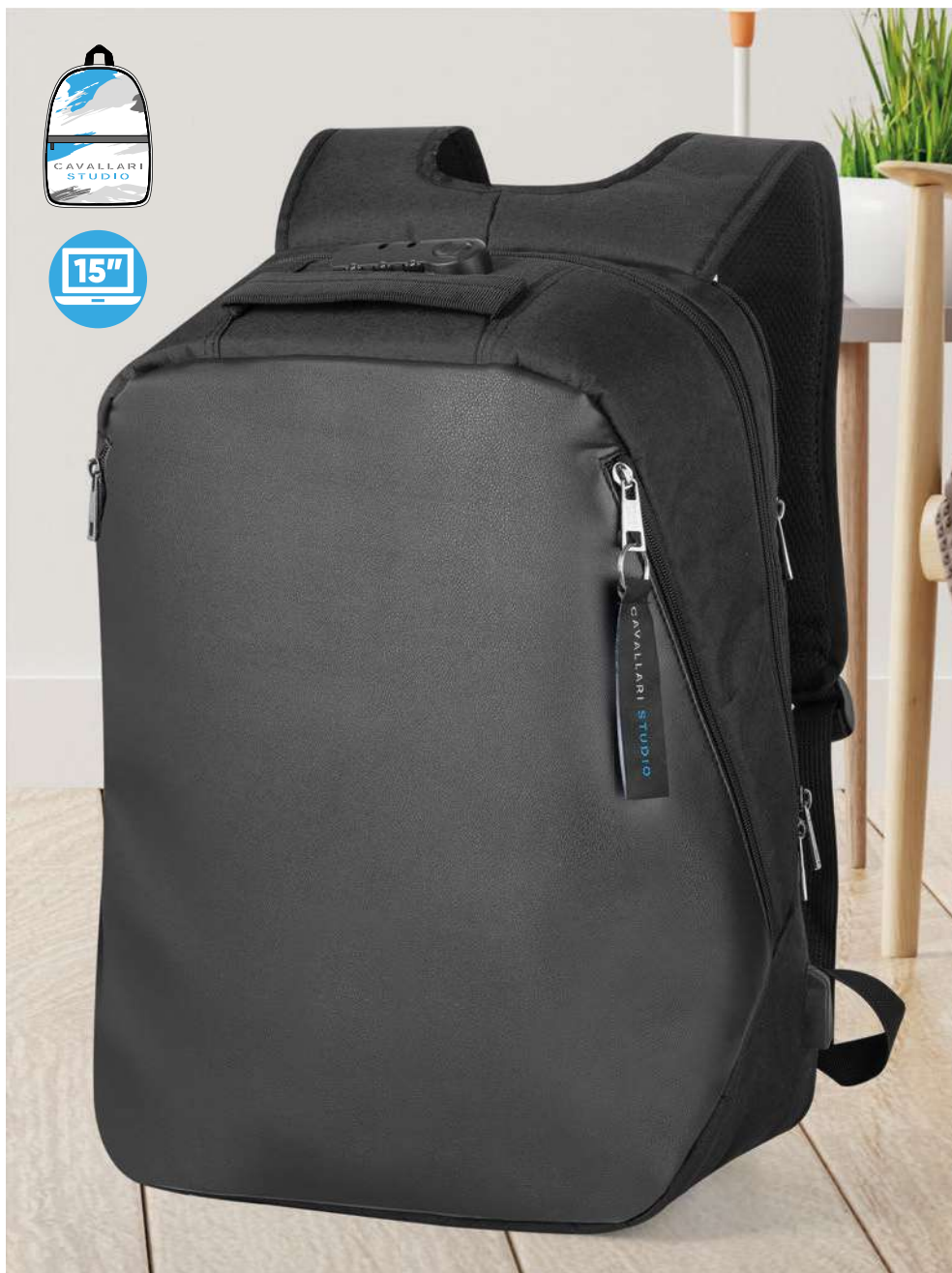

connettore USB integrato



tasca antirapina sul retro



lucchetto con combinazione a 3 cifre

**CA039 TYPE STUDIO**

zaino in poliestere 420D e PU  
 scomparto su retro chiusura antitaccheggio  
 tasca per pc e tablet, connettore USB  
 fascia per trolley sul retro, spallacci imbottiti  
 retro imbottito con tasca nascosta  
 moschettone interno portachiavi  
 lucchetto con combinazione a 3 cifre  
 2 tasche anteriori con zip, taschino interno con zip  
 borsa in tnt Cavallari Studio inclusa



40x46x19 cm ca

1/20 SE



**CAVALLARI  
STUDIO**

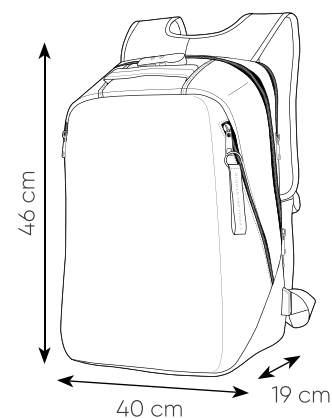



GR



connettore USB integrato



disponibile in 2 colori: GR - NE



vano interno per laptop e tablet

**CA043 TODAY**

zaino in ecopelle, chiusura full zip  
fibbia in metallo, vano interno  
tasca per pc e tablet, fondo rigido  
taschino interno con zip  
retro e spallacci imbottiti  
tasca frontale e laterale  
tasche laterali, connettore USB



30x50x15 cm ca  
1/25 SE



NE

**CAVALLARI  
STUDIO**

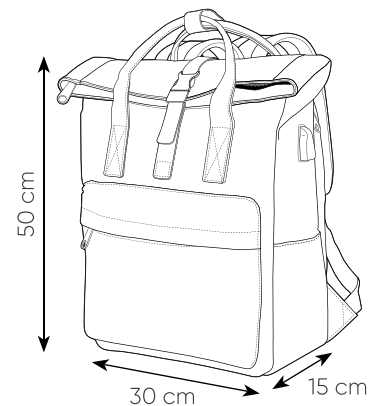



connettore USB integrato



fascia posteriore per trolley



vano interno per laptop e tablet

**CA046 POSH**

zaino in nylon 180D  
 2 tasche anteriori con zip  
 fascia per trolley sul retro  
 vano 2 tasche e porta penne  
 tasca imbottita per pc e tablet  
 tasche laterali in materiale traforato  
 connettore USB, retro e spallacci imbottiti  
 borsa in tnt Cavallari Studio inclusa



32x46x15 cm ca  
 1/25 SE



CAVALLARI  
 STUDIO

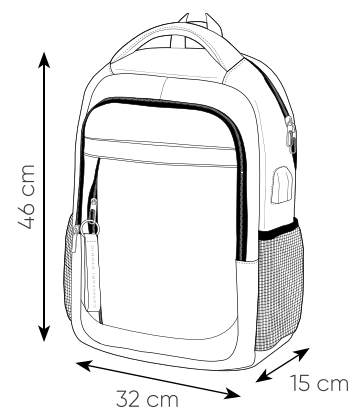



cinghia toracica per ridurre il carico di peso



vano interno con rete e chiusura con zip



fascia posteriore per trolley



tasca antirapina sul retro

## FORMATO BAGAGLIO A MANO COMPATIBILE CON LE PRINCIPALI COMPAGNIE AEREE

### CA055 MODULAR

zaino in poliestere 900D impermeabile  
vano imbottito interno porta pc/tablet  
compartimento interno con mesh  
doppia tasca con zip di chiusura  
tasca laterale con cerniera  
vano estensibile, connettore USB  
materiale resistente all'acqua



46x30x22,5 cm ca  
1/10 SE



**ZAINO ESPANDIBILE  
PER AUMENTARE LA CAPIENZA**



### CA056 BUSINESS COMBO

zaino in ecopelle, doppia tasca con zip di chiusura, vano imbottito interno porta pc/tablet, spallacci removibili e richiudibili in tasca sul retro, tracolla sganciabile con manico imbottito traspirante



40x30x10 cm ca

1/1 SE

CAVALLARI  
STUDIO



spallacci a scomparsa



Tracolla sganciabile



varie tasche interne e portachiavi

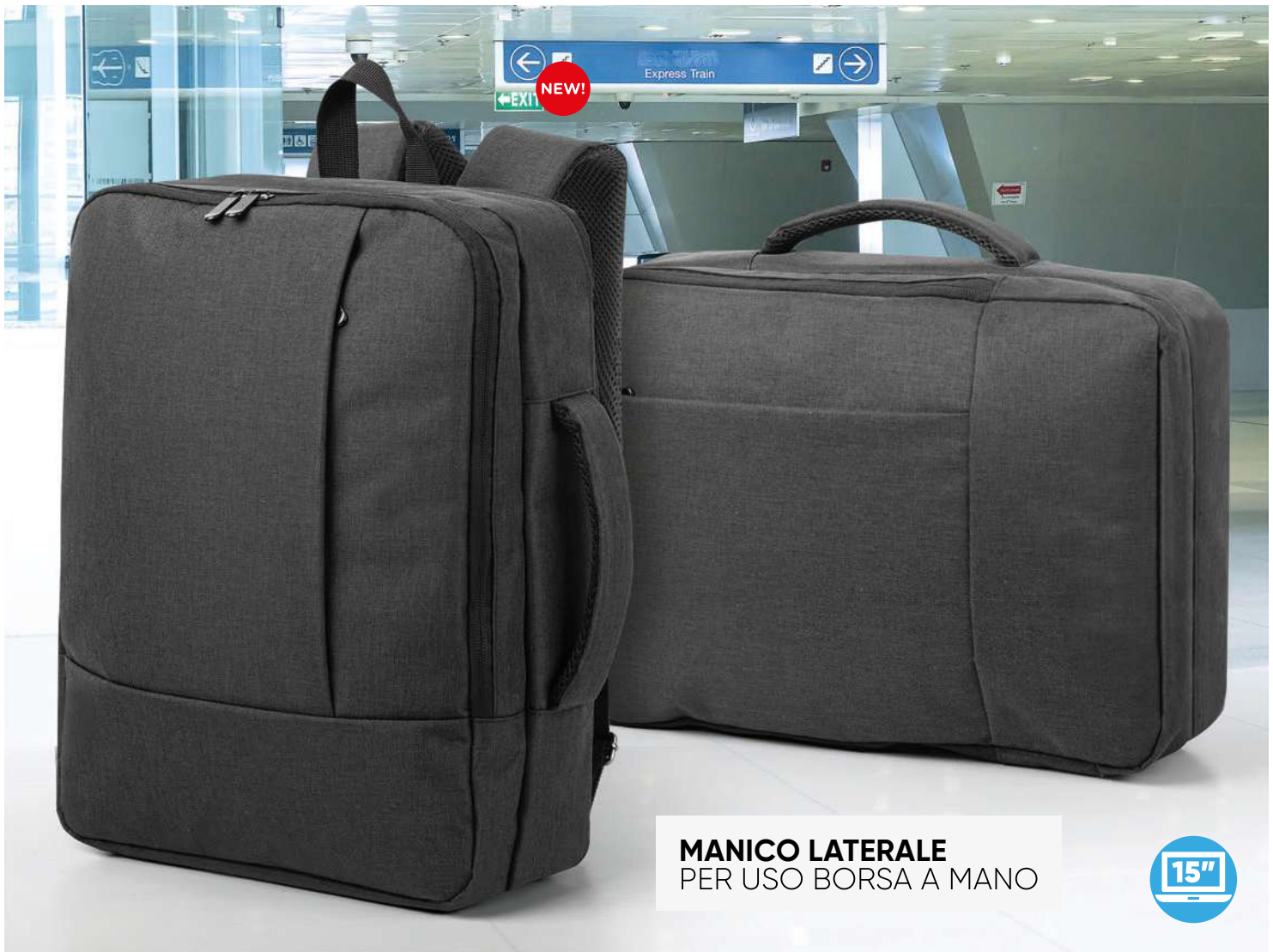

**MANICO LATERALE**  
PER USO BORSA A MANO



## PG500 CARRY

zaino poliestere 300D, tasca porta documenti, tasca imbottita porta pc/tablet, fascia trolley posteriore, spallacci imbottiti e regolabili a scomparsa



41x29x12 cm ca

1/20 SE



fascia posteriore per trolley



spallacci imbottiti a scomparsa



tasca anteriore



tasche interne

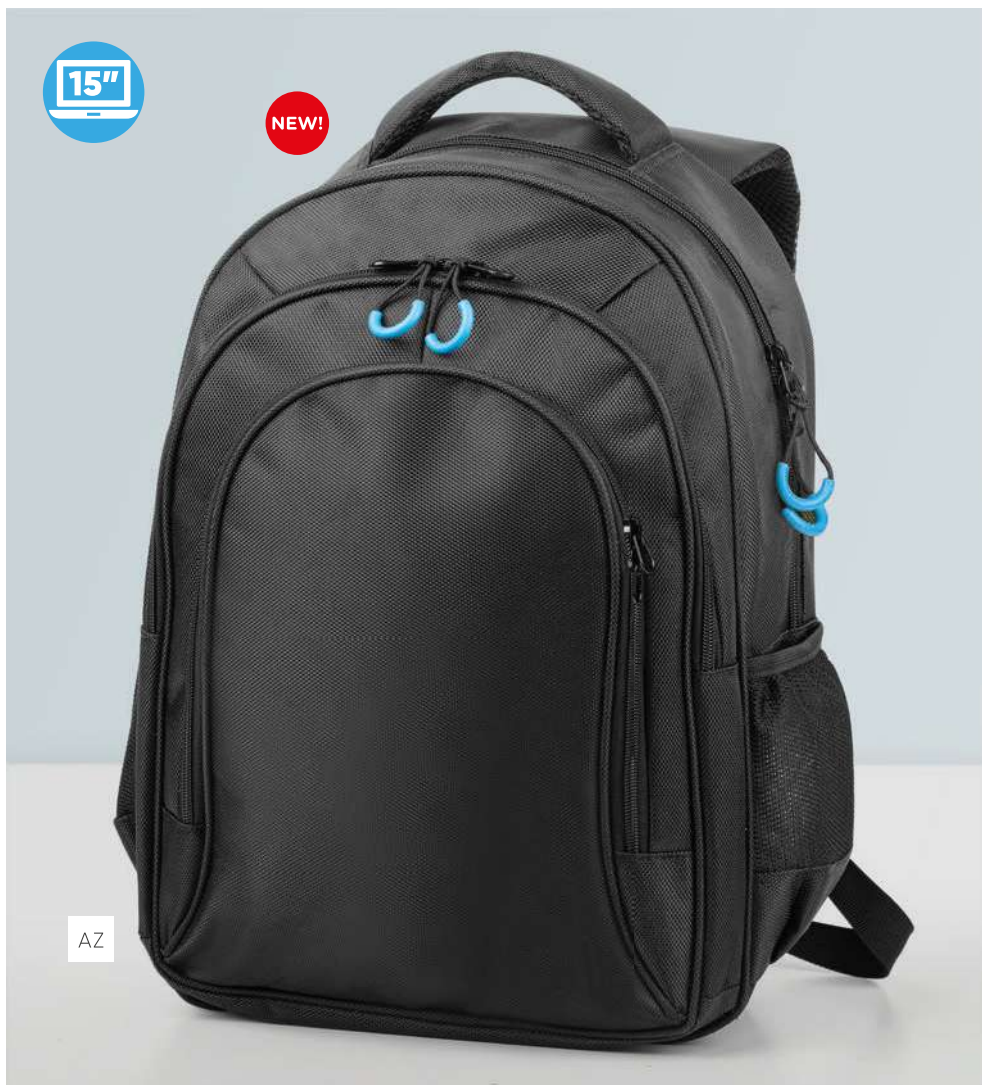

tiralampo con grip colorato



tasca laterale traforata



vano interno per laptop e tablet

### PG501 EVERYDAY

zaino in poliestere 1680d, 3 tasche con zip e tiralampo, vano interno imbottito porta pc, spallacci imbottiti e traspiranti, tasche laterali in materiale traforato



30x45x16 cm ca

1/10 SE



AR



BL



NE



RO



VL







BL



tasca anteriore a scomparsa



tasca antirapina sul retro



fascia posteriore per trolley

## PG502 COLLEGE

zaino in RPET 300D, chiusura sul retro antitaccheggio, schienale e spallacci imbottiti  
tasca interna imbottita porta pc/tablet, fascia trolley posteriore, tasca frontale



32x42x12 cm ca

1/10 SE



GR



NE





chiusura con fibbia e zip



tasca anteriore con zip



tasca sul retro antirapina

## PG503 KAYAK

zaino in PU impermeabile, interno effetto suede con tasca porta PC  
tasca frontale con cerniera, profilo catarifrangente, tasca sul retro  
con imbottitura traspirante, spallacci imbottiti e regolabili



27x54x12,5 cm ca  
1/20 SE



BL



VE



rivestimento impermeabile



zip in metallo



tasca anteriore



ampia tasca laterale traforata

## PG513 HYAMS 2-TONE

zaino in poliestere 600D, effetto melange, vano imbottito interno porta pc  
tasca frontale con zip, tasca laterale in materiale traforato, spallacci imbottiti e regolabili



31x42x11 cm ca

1/20 SE



GR



BL



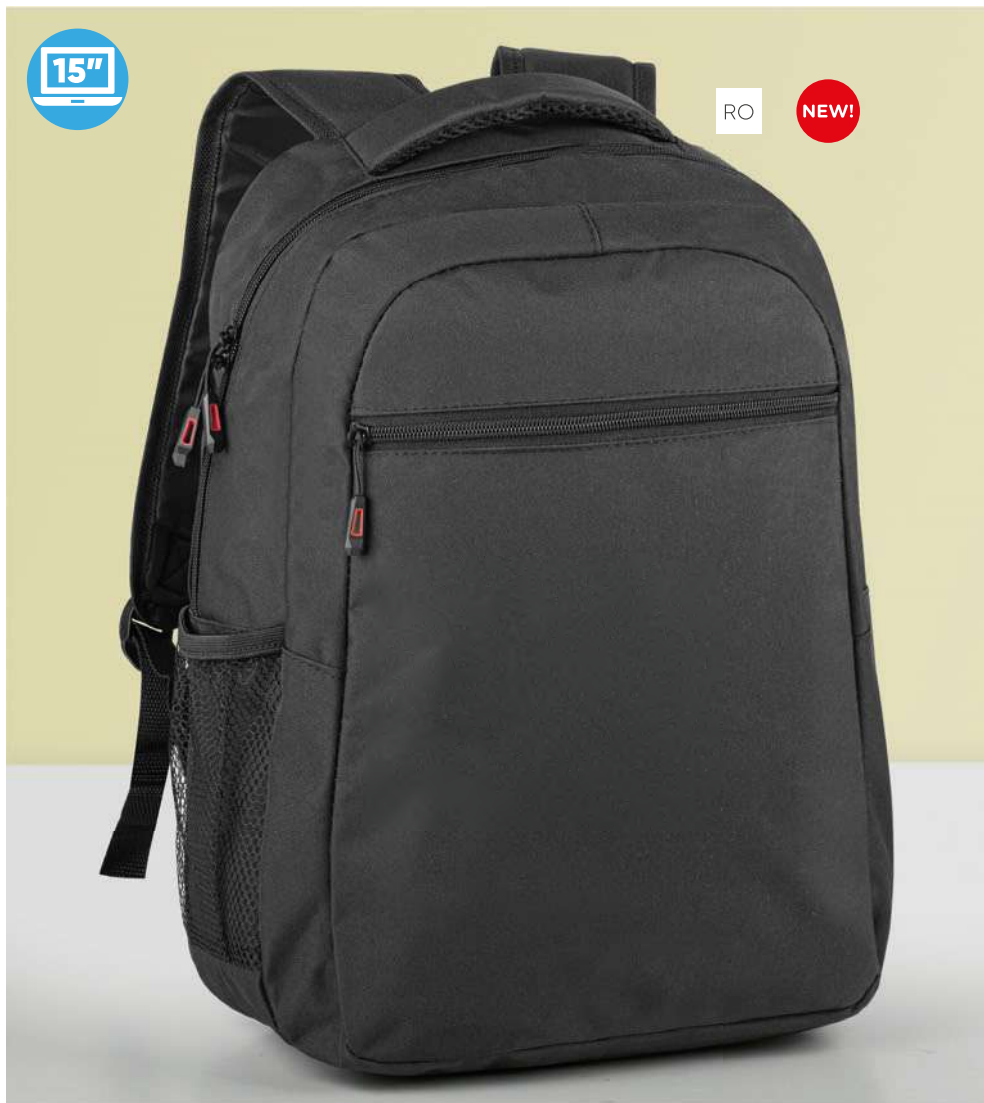

tiralampo con cursore colorato



tasca anteriore



ampia tasca laterale traforata

### PG514 HYAMS

zaino in poliestere 300D, vano imbottito interno porta pc, tasca frontale con cerniera e tira lampo  
spallacci imbottiti e regolabili, tasca laterale in materiale traforato



31x42x11 cm ca

1/20 SE



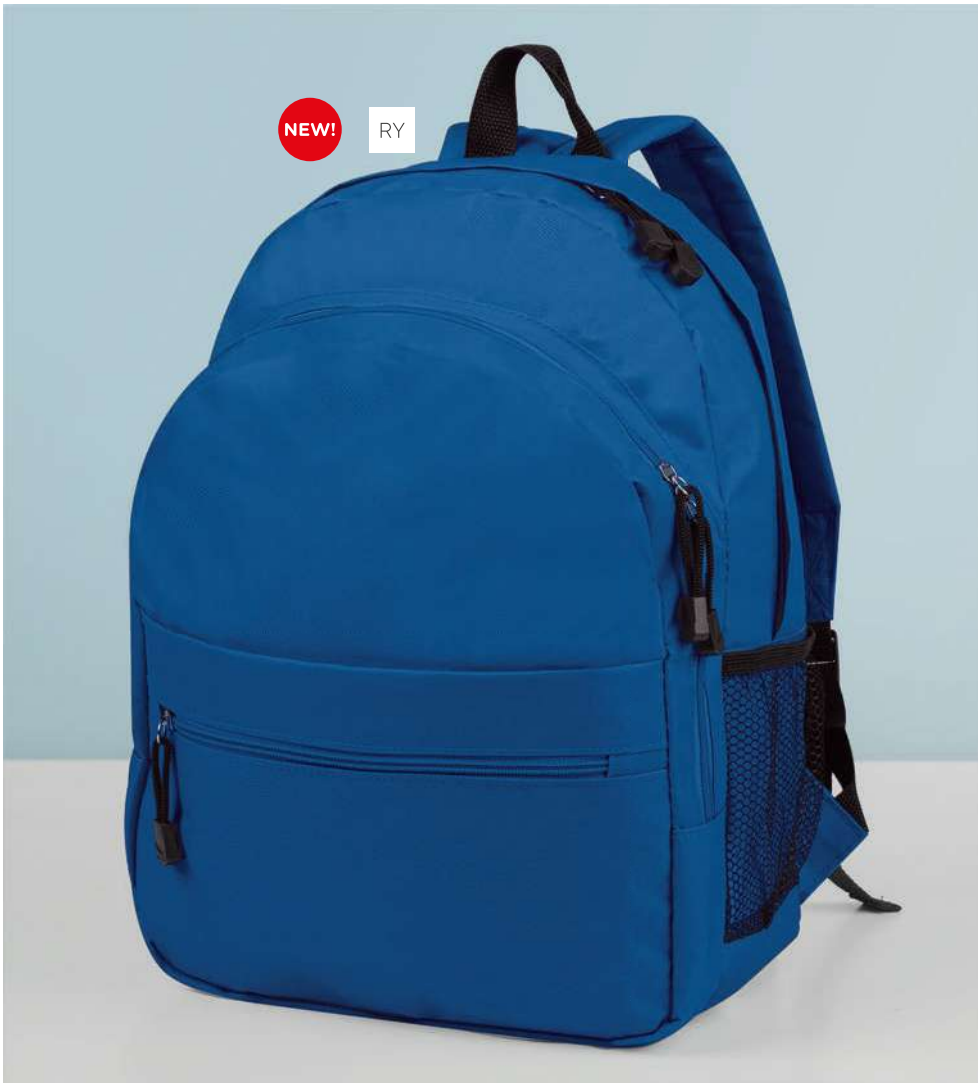

tiralampo con cursore



tasca anteriore



ampia tasca laterale traforata

**PG516 UNIVERSITY**

zaino in poliestere 600D  
 doppio compartimento con cerniera  
 due tasche frontali  
 spallacci imbottiti e regolabili  
 tasca laterale in materiale traforato



31x41x16 cm ca  
 1/40 SE

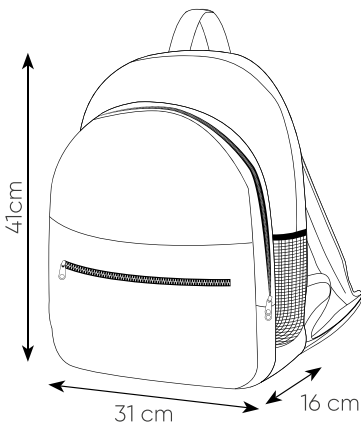



zip con cursore



spallacci imbottiti



2 ampie tasche laterali traforate

## PG517 ADVENTURE

zaino in poliestere 600D, vano interno imbottito, tasca frontale con zip, tasche laterali in materiale traforato elastici stringenti frontali, spallacci imbottiti e regolabili



30x45x15,5 cm ca

1/20 SE



AR



NE



RO



RY



VL

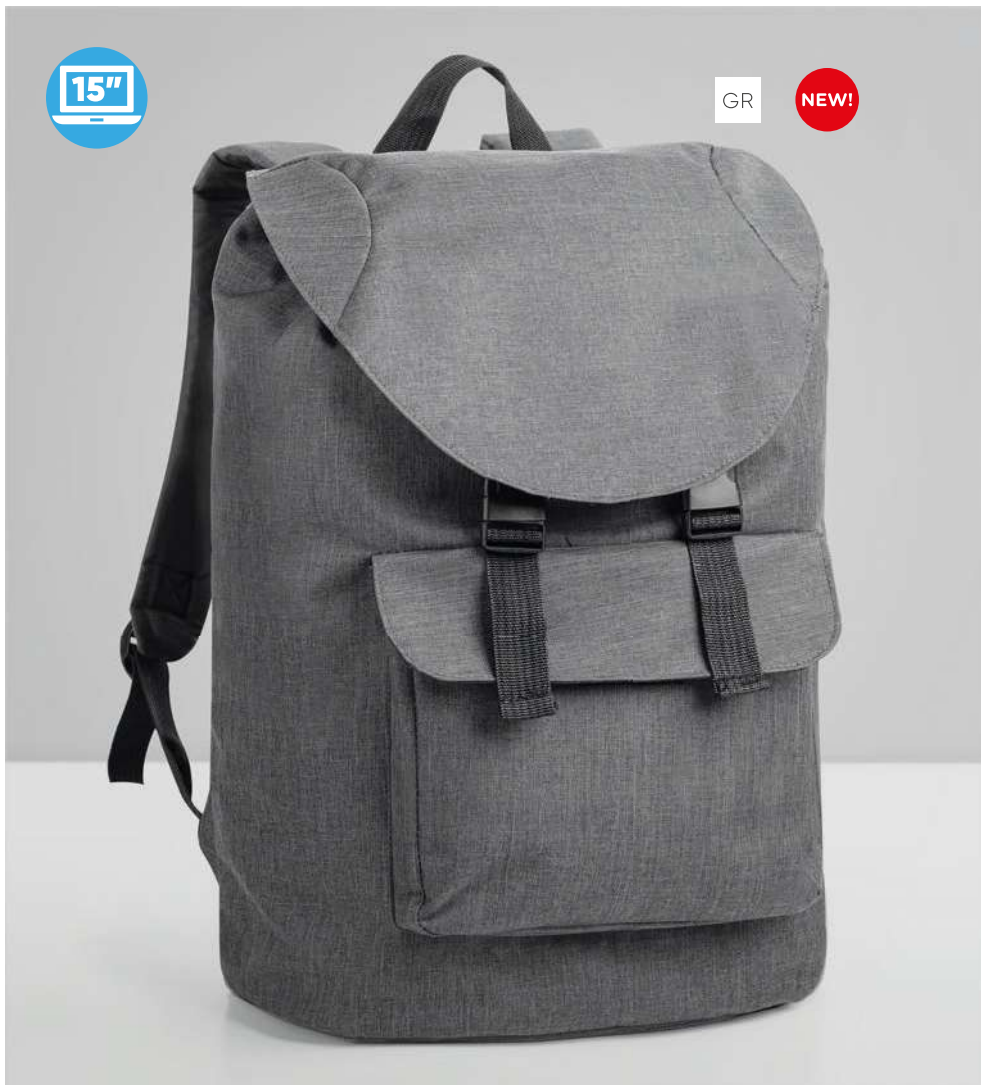

chiusura superiore a sacco



ampia tasca frontale con velcro



tasca interna con zip

## PG521 EDINBURGH

zaino in poliestere 300D, effetto melange, tasca frontale, chiusura con fibbie  
spallacci imbottiti e regolabili, vano interno porta pc fino a 15"



30x41x16 cm ca

1/20 SE



BL



NE





### PG235 BUISY

zaino/tracolla in poliestere 600D, tracolla 3 tasche con zip, vano interno porta pc (15,6")



32x38x9,5 cm ca

1/10 SE TR



tasca porta documenti



spallacci removibili a scomparsa

### PG251 SAHARA

zaino in canvas, chiusura con zip fibbie in legno, tasca frontale con zip



COTONE CANVAS



30x42x11 cm ca

1/30 SE TR

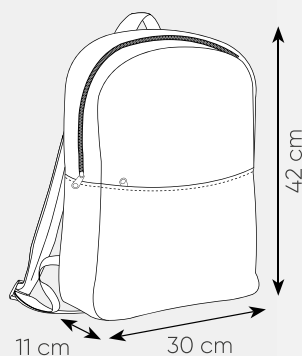

fibbie in legno





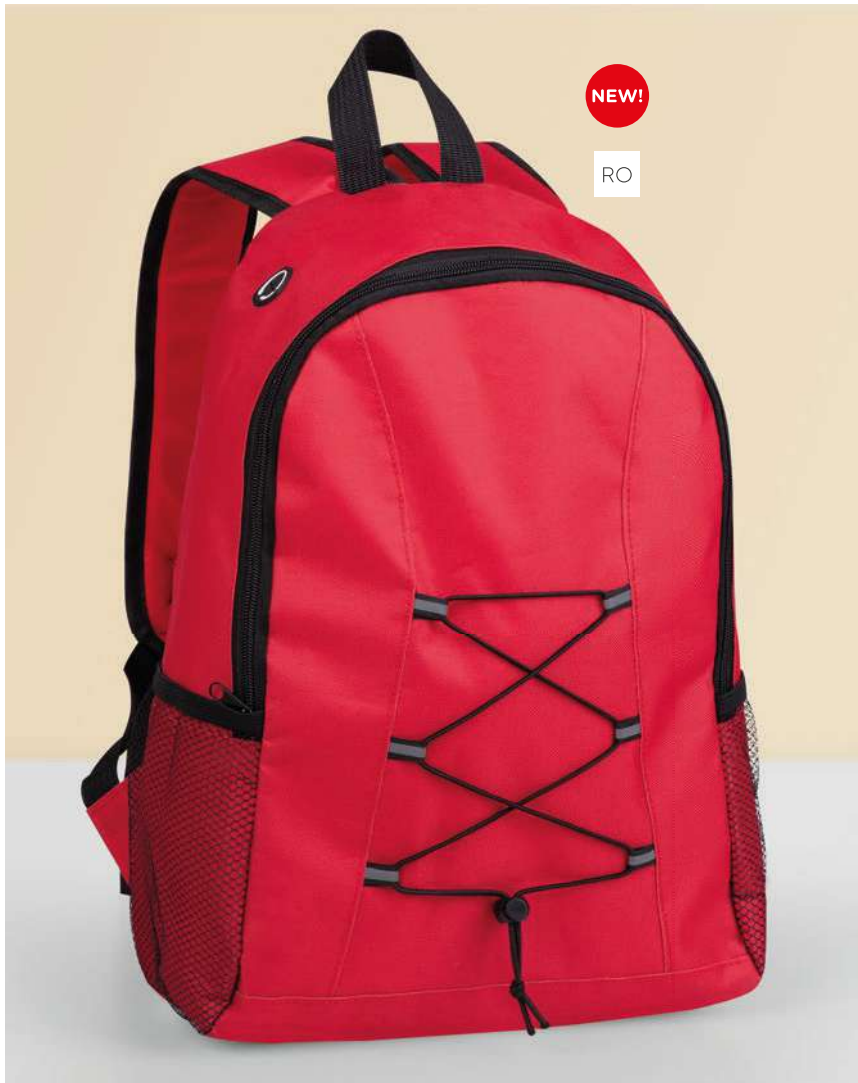

### PG240 HIKING

zaino poliestere 600D  
 ampio vano interno  
 foro per auricolari  
 doppia tasca laterale traforata  
 spallacci imbottiti e regolabili  
 elastico frontale regolabile



31x41x16 cm ca

1/40 SE



AR



BI



BL



FX



foro per passaggio  
 degli auricolari



GI



NE



RY



VE



VL



**PG293 STREET**

zaino in polistere 600D  
tasca con zip  
spallacci imbottiti regolabili  
tasche laterali traforate



30x40x18 cm ca  
1/50 SE SU(BI) TR



AR



BI



BL



FX

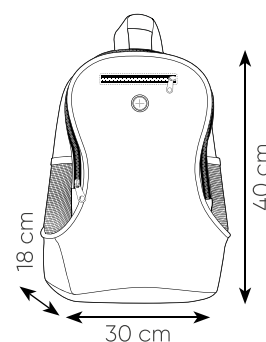

GI



NE



RY



VL





RY



**PG300 TRACK**

zaino in polistere 600D  
 retro e spallacci imbottiti  
 tasca anteriore  
 tasca laterale traforata



31xh40x18 cm ca

1/10 SE TR



BL



NE

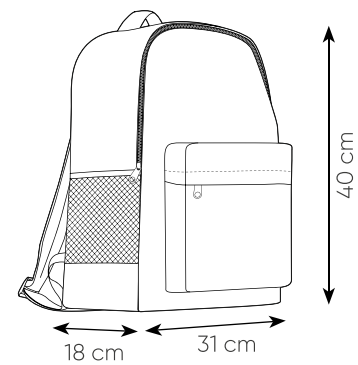

RO



VE





**PG310 EASTWEST**

zaino in poliestere 600D  
tasca anteriore  
retro e spallacci imbottiti



26,5xh38x12 cm ca

1/50 SE TR



**PG316 RESIZE**

zaino in poliestere, richiudibile in tasca



30x44x15 cm ca

10/100 SE SU(BI) TR



AR



BI



NE



RY

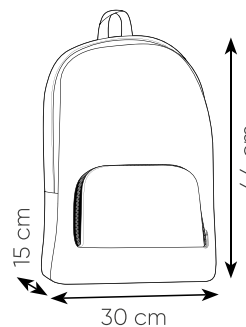

VE

richiudibile in tasca anteriore:  
cm 20x14 ca

### PG261 FREE

sacca zaino in RPET, doppia corda di chiusura



33x45 cm ca  
10/200 SE SU (BI) TR



RPET  
ZERO SPRECHI

AR



BI



BL



NE



RO



VE

### PG279 GOAL

sacca zaino in poliester 190T  
doppia corda di chiusura  
piegabile in pouch



37x44 cm ca  
10/100 SE TR

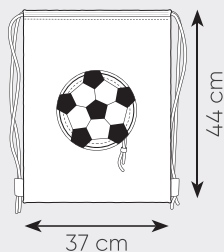

stampabile anche  
sul lato posteriore



BL



RO



GI

## SACCA ZAINO CON TASCA FRONTALE

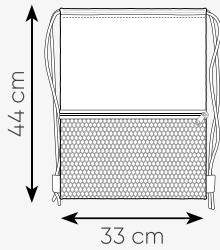

### PG278 REFRAIN

sacca zaino in poliestere 210D  
doppia corda di chiusura  
tasca traforata con zip



33x44 cm ca

10/200

SE SU(BI) TR





**PG280 PLAY**

sacca zaino in poliestere 210D  
doppia corda di chiusura



33x45 cm ca 10/200

SE SU (colori a base bianca) TR

COLORI CON BASE  
BIANCA ADATTI ALLA  
**STAMPA SUBLIMATICA**



BL

WV



AR

AZ

BI

FX

GI

NE

RO

RS



RY

VE

VL

WA

WB

WG

WR

WY

WZ



SACCA ZAINO  
CON CORDA  
COLORATA

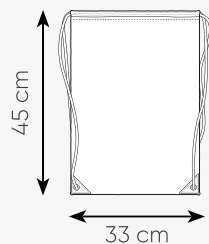

VL



**PG480 NOA**

sacca zaino in poliestere 210D, doppia corda di chiusura colorata



33xh45 cm ca

10/200 SE SU(BI) TR



AR



BI



BL



FX



GI



NE



RF



RO



RY



VE



VF





MARSUPIO  
UNISEX  
**IN RIPSTOP**



**PG361 KANGAROO**

marsupio sportivo in ripstop, cintura regolabile  
2 tasche frontali, 1 tasca posteriore con zip

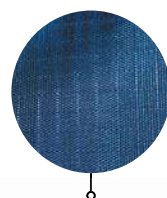

ripstop  
antistrappo



30x12 cm ca  
10/200 SE TR



2 tasche frontali  
1 tasca posteriore

RY

**PG367** JEANY

tracolla tempo libero in denim, cerniera frontale  
tasca frontale, tracolla regolabile



28x39 cm ca  
1/50 SE TR

**PG368** M-JEANY

tracolla tempo libero in canvas, cerniera frontale  
tasca frontale, tracolla regolabile



28x39 cm ca  
1/50 SE TR

**PG364** COSMO

cartella portadocumenti  
poliestere 600D  
chiusura interna con zip  
pattina con chiusura a velcro



28x35x7 cm ca  
1/50 SE TR

chiusura  
superiore  
con zip





TESSUTO  
EFFETTO  
**MELANGE**

GR



vano portascarpe laterale



connettore usb integrato



tracolla removibile

**PG265 GYM**

borsa sport/viaggio in poliestere 420D, manici rinforzati, tracolla removibile  
connettore USB, vano porta scarpe laterale, tasca con zip laterale



50x30x28,5 cm ca

1/25 SE TA

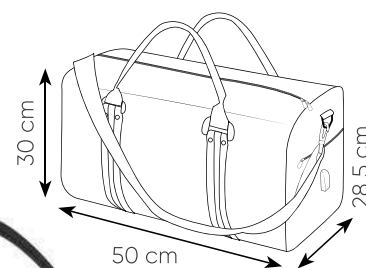

BL



GS



tiralampo in tessuto



piedini in plastica



tracolla removibile

## PG267 NESS

borsone sport in poliestere 600D  
 doppio manico con chiusura in velcro  
 doppie tasche laterali  
 tiralampo in tessuto  
 tracolla regolabile  
 piedini in plastica



60xh34x30 cm ca

1/20 SE TR

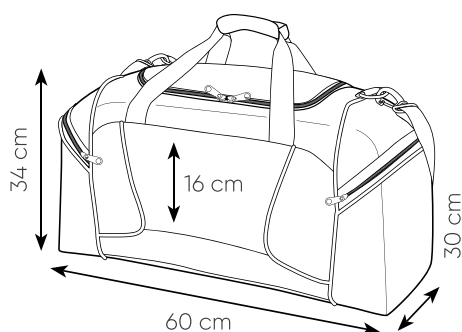



tasca laterale con zip



tiralampo in tessuto



piedini in plastica

## PG271 NET

borsone sport in poliestere 600D  
 apertura superiore con doppio cursore  
 tiralampo in tessuto, tracolla regolabile  
 piedini in plastica, tasche laterali



56x31x28 cm ca  
 1/25 SE TR

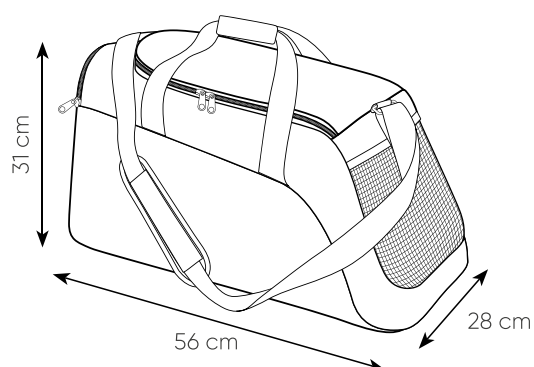

RO



GR





vano scarpiera traspirante



pedini in plastica



tracolla con gancio

### PG273 FOOTBALL

borsone sport in poliester 600D  
salvaspalla imbottito, piedi in plastica  
tascone esterno, portanome laterale  
tiralampo in tessuto, tracolla regolabile  
vano scarpiera con pareti rigide pieghevoli



53x43x31 cm ca  
1/20 SE TR

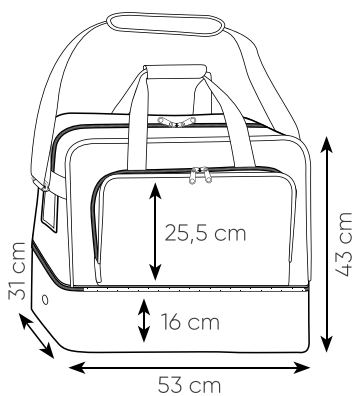

BL



NE



RO



VE



RO

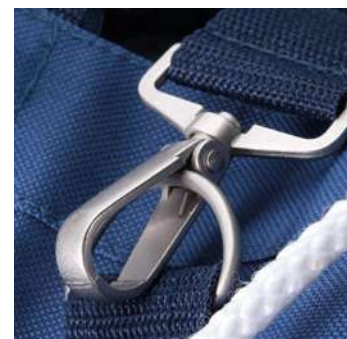

chiusura con gancio



spallacci imbottiti

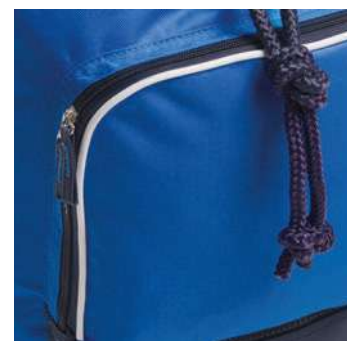

tascone frontale con zip

### PG274 EQUIPE

sacca zaino poliestere 600D, scarpiera, spallacci imbottiti regolabili, tiralampo, doppia corda, tascone frontale con zip



37xh56x25 cm ca

1/15 SE TR



BL



BW



NG



RY



SPALLACCI  
POSTERIORI  
**E DOPPIO  
MANICO**

RY



## PG281 CRAWL

zaino sport in poliestere 600D  
scarpiera cm h11 ca  
sacca interna portabiancheria  
tiralampo in tessuto



30xh58x27 cm ca

1/20 SE TR



sacca interna  
porta biancheria

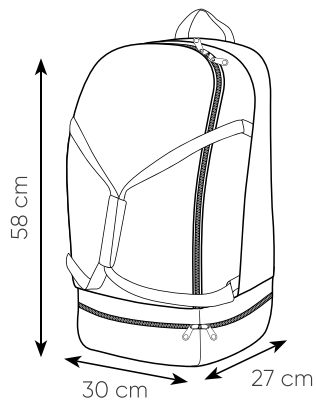

BL



NE

07.

VIAGGIO  
E TEMPO  
LIBERO





NE

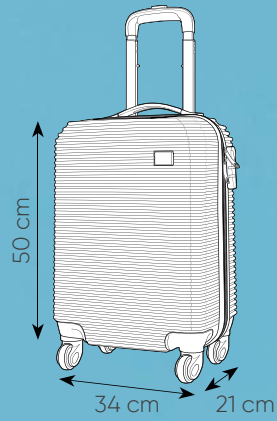

## BAGAGLIO A MANO ULTRALEGGERO E RESISTENTE



### PG218 ROVER

trolley/bagaglio a mano in ABS, 4 ruote, antigraffio e antiurto  
maniglia a scomparsa, manico telescopico, interno con cinghie ferma abiti  
chiusura combinazione 3 cifre, scomparti con chiusura zip



34x50x21 cm ca 2,35 kg  
1/1 SE



combinazione a 3 cifre



etichetta personalizzabile



interno multitasche con cinghia per abiti



BL



SI



**COPRI ABITI  
DA ARMADIO  
E SARTORIA**  
in tnt con soffietto



finestra trasparente



doppio manico



BL

## PJ701 TUXEDO

copri abiti da viaggio in tnt  
soffietto, richiudibile con velcro  
finestrella per identificazione



100x60x10 cm ca

10/100 SE



NE



### PJ700 TAGGY

etichetta per valigia in plastica  
targhetta interna, cordoncino in gomma



5,5x9 cm ca  
50/500 SE TA UV



AR



BI



RY



NE



VL

### PJ650 TAGLY

etichetta per valigia in plastica,  
targhetta interna, fascetta in plastica



5x9 cm ca 10/500 SE TA UV



VL



AR



BI



NE



RO



RY





### PJ705 TRAVEL SET

set da viaggio con custodia in poliestere, tappi insonorizzati in pvc  
maschera in poliestere con doppio elastico cm 19xh6,5  
cuscino poggiatesta gonfiabile cm 40x27



17x11,5 cm ca  
50/250 SE



BL



NE



set composto da:  
maschera, tappi  
e cuscino gonfiabile



### PJ580 TRAVEL

portadocumenti da viaggio in poliestere 600D, tasca con cerniera, laccio da polso, profili a contrasto



29,5xh18,5 cm ca  
50/200 SE TR



RY



**PORTA DOCUMENTI DA VIAGGIO**  
tasca con cerniera  
laccio da polso

PJ583RO

**NEW!**

PJ582RY

**PJ582 TRAVELING S**  
poliestere 600D



☑ 26,5x13,5 cm ca  
📦 50/200 🏠 SE TR

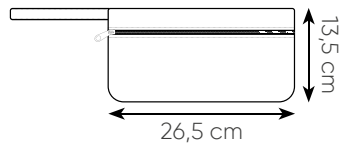

**PJ583 TRAVELING**  
poliestere 600D



☑ 30x18 cm ca  
📦 50/200 🏠 SE TR

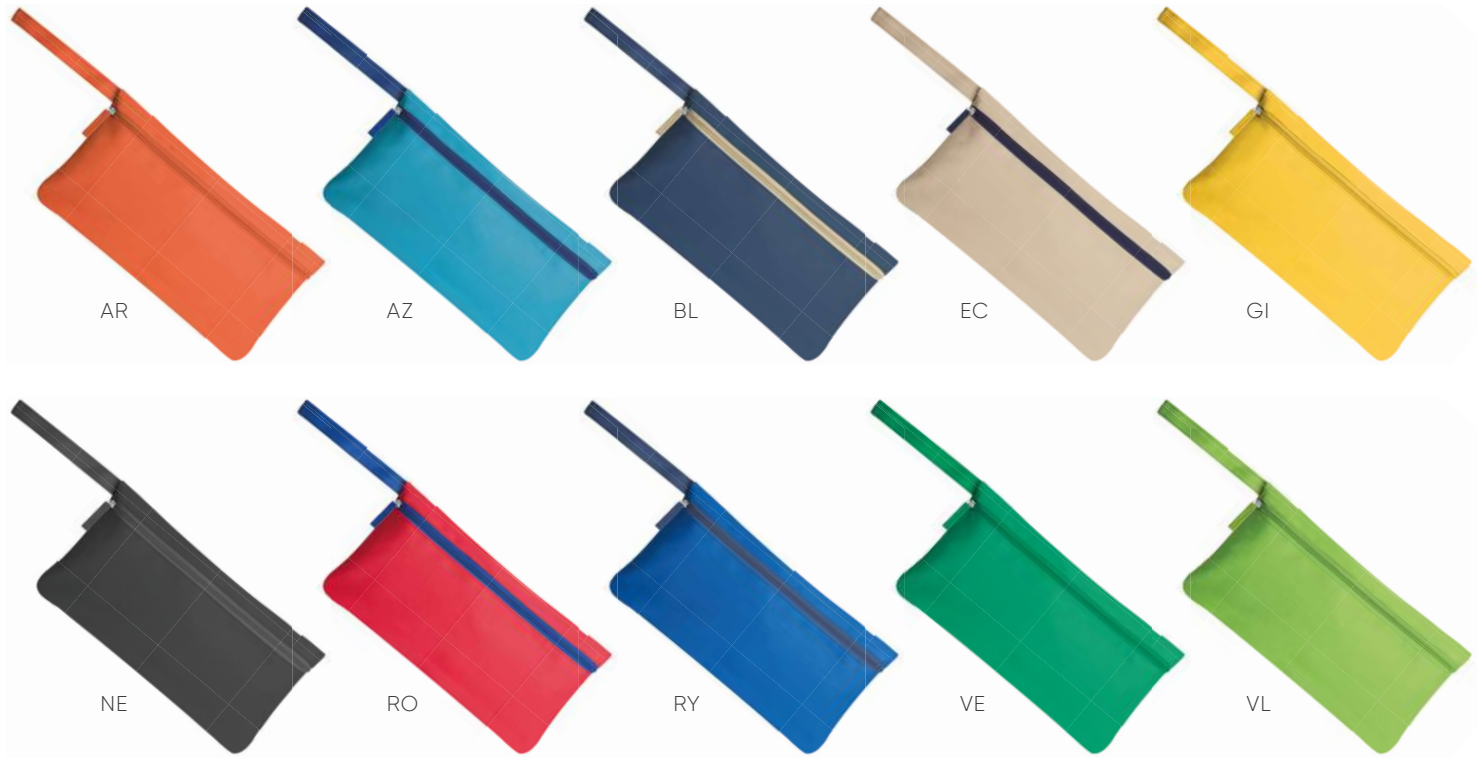
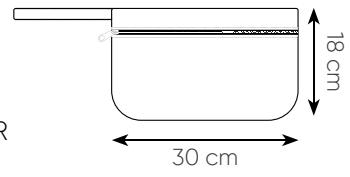



PORTA DOCUMENTI  
**DOPPIO SCOMPARTO**

**PJ585 VOUCHER**

portadocumenti da viaggio in poliesteri 600D  
2 scomparti, chiusura in velcro



26,5x13,5 cm ca  
50/200 SE TR



AR

AZ

BL

EC

GI

NE

RO

RY

VL

**PJ602 LUCKY**

portalotto e porta biglietto aereo in PVC, 2 tasche interne



12x24 cm ca  
100/500 SE UV

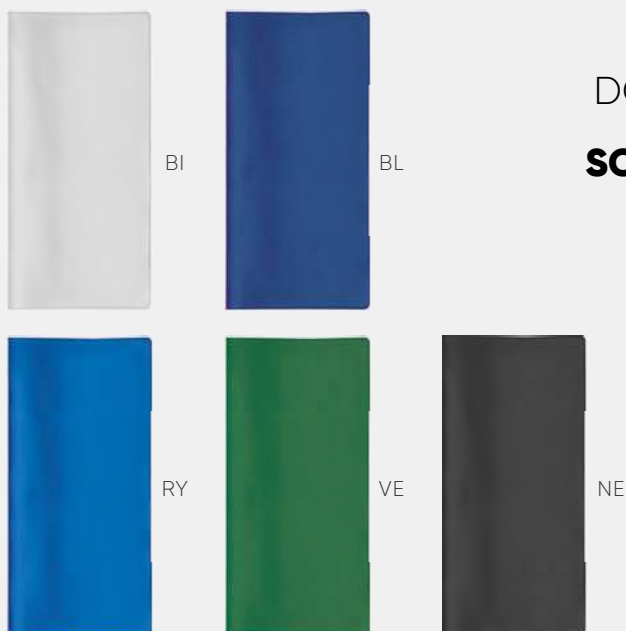

BI

BL

RY

VE

PORTA  
DOCUMENTI  
**DOPPIO  
SCOMPARTO**



RO



## NECESSAIRE DA VIAGGIO

utili sia per viaggi  
brevi che per la  
giornata fuori casa

NEW!

RO

 **BEAUTY**  
THERAPY + WELLNESS

### PI310 CASE

beauty case in poliestere 600D, chiusura con zip, cerniere rinforzate in metallo, interno impermeabile  
linguetta in poliestere, laccetto laterale



📏 21,5x13,5x8 cm ca 📦 10/200 🌐 SE TR



AZ



BI



BL



FX



NE



RY

**PI311 BEA**

beauty case in poliestere 600D  
 interno impermeabile  
 cerniere rinforzate in metallo  
 linguetta in poliestere su zipper puller



30x20x10 cm ca  
 10/200 SE TR



AZ



BL



NE



RO



VE

**ASTUCCIO MULTIUSO**

grazie alla sua versatile forma è utilizzabile sia come beauty case da viaggio che come astuccio portapenne.

**PI315 HOLDER**

astuccio in poliestere 600D, chiusura zip, cerniere rinforzate in metallo



21x9,6x6,5 cm ca  
 10/200 SE TR



VE



AR

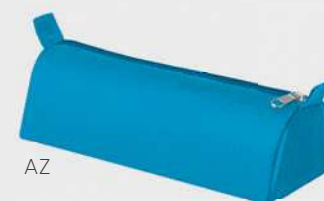

AZ



BL



RO



NE



**RPET**  
ZERO SPRECHI

BL

### PI312 R-BEAUTY

beauty case in RPET, chiusura con zip, cerniere rinforzate in metallo, interno impermeabile, maniglia laterale



25x14x9 cm ca 10/200 SE TR



BL



GR



NE

### PI313 POLLY

beauty case in poliestere 600D, interno impermeabile  
cerniere rinforzate in metallo, laccetto laterale



14x9,5x7,5 cm ca  
10/200 SE TR



### PI314 TRUDI

beauty case in poliestere 600D, interno impermeabile  
cerniere rinforzate in metallo, laccetto laterale



14x9,5x7,5 cm ca  
10/200 SE TR





PI320RY

PI318VE

**PI318 HANDHELD**

necessaire da viaggio in snow nylon 300D  
chiusura con cerniera, interno lavabile



24x14x9 cm ca  
10/200 SE TR

**PI320 BEAUTY**

necessaire da viaggio poliestere 600D  
chiusura con cerniera lampo, tasca frontale



22x18x9 cm ca  
10/100 SE TR



BL



BO



GR

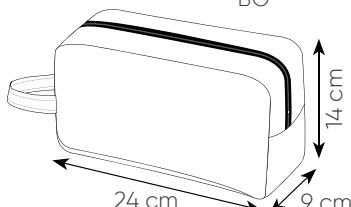

BL



NE



RO

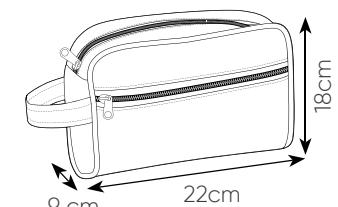



PI322BL



PI321NE

NECESSAIRE  
DA VIAGGIO  
**IMPERMEABILI**  
**SOFT TOUCH**

**PI321 KALOS**

beauty case in pu soft touch  
cerniere rinforzate in metallo  
interno impermeabile



21x14x5 cm ca  
10/200 SE TR



BL



GR



VS

**PI322 HEAVEN**

beauty case in pu soft touch  
cerniere rinforzate in metallo  
interno impermeabile  
maniglia laterale



23x13x10 cm ca  
10/100 SE TR



GR



NE



VS



PI330



SUSTAINABLE SELECTION

PI333RO



**PI330 CASE**

necessaire da viaggio in cotone canvas pettinato chiusura con cerniera



30x20x10 cm ca  
390 g 10/100 SE TR



**PI333 MILA**

necessaire da viaggio in cotone chiusura con cerniera



23x18x8 cm ca 180 g  
10/100 SE TR



### PI335 MARGOT

necessaire da viaggio, cotone e juta  
chiusura con cerniera



21,5x16,5x5 cm ca 180 g  
50/250 SE TR

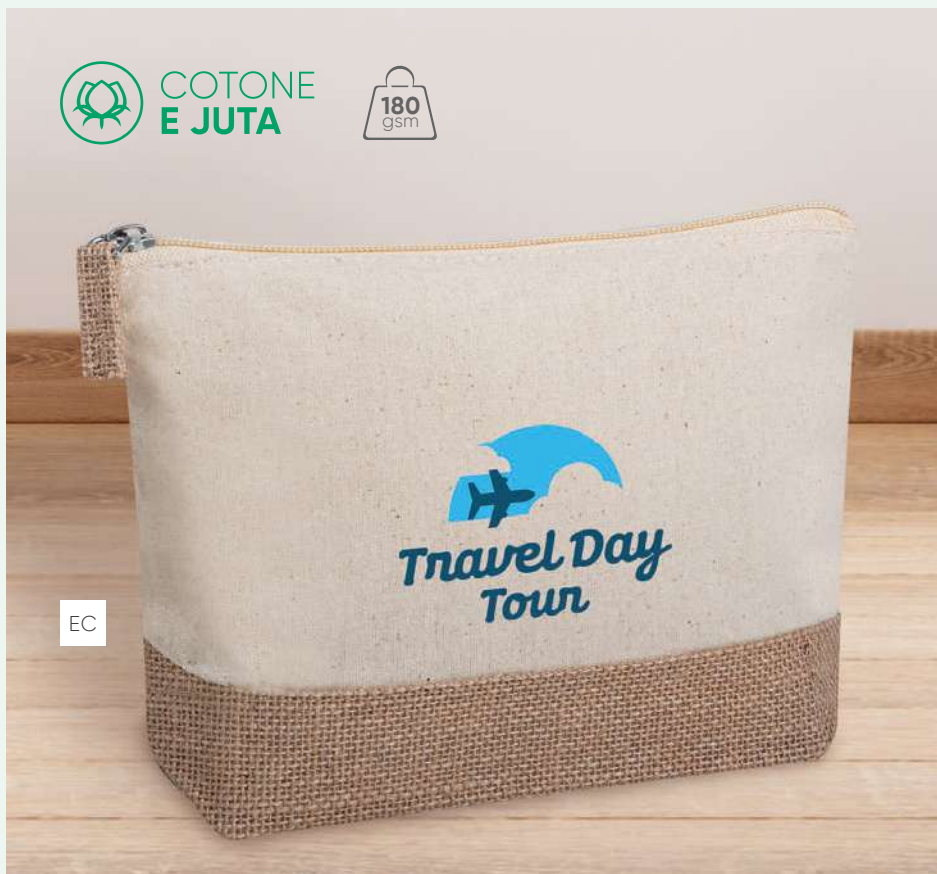

### PI334 CAMILLE

necessaire da viaggio  
cotone riciclato  
chiusura con cerniera  
laccio da polso



26x17 cm ca 200 g  
50/250 SE TR







COTONE  
CANVAS



NEW!



### PI337 CLARA

necessaire da viaggio  
cotone pesante  
chiusura con cerniera rinforzata  
linguetta in cotone



24,5x16 cm ca 300 g

10/200 SE TR



### PI340 VISIO

beauty case in pc, impermeabile  
chiusura a pressione



17x13,5x4,5 cm ca

50/400 SE TR



AR



BL



GI



TR



VE



UTILE COME  
POCHETTE  
NELLA BORSA MARE

RO

**PI351 CHARLOTTE**

set da borsa in bamboo e cotone  
mini spazzola e specchio con manico  
pouch in cotone incluso



- ☑️ spazzola: 16x4x1 cm ca
- ☑️ specchietto: 15,5x7x1 cm ca
- ☑️ pouch: 14,5x12,5 cm ca
- 📦 25/100 🌱 IN SE TA UV

**PI395 BAMBOO MIRROR**

specchietto da borsa in bamboo



- ☑️ Ø 7,2x1 cm ca
- 📦 50/200 🌱 IN SE TR UV



SUSTAINABLE  
SELECTION

NEW!





**SPAZZOLA  
DOPPIO  
USO**  
con specchio  
sul retro

**PI415 CLARISSA**

spazzola in plastica con specchietto



☑ 15x7,5 cm ca

📦 60/240 🌐 SE TA UV

**PI490 CLAIRE SET**specchietto richiudibile in plastica  
confezione in tnt, astuccio

☑ aperto: 17,5x8,3 cm ca

☑ chiuso: Ø 8,3 cm ca

📦 100/300 🌐 SE TA UV

DOUBLE  
FACE  
**DOPPIO  
INGRANDIMENTO**



SPECCHIETTO  
RICHIUDIBILE  
**IN FORMATO  
DA BORSETTA**



SPAZZOLA  
DISTRICANTE  
**ANTINODI**

**PI522 CELINE**

spazzola in plastica districante antinodi



📏 6,7x9x4,5 cm ca  
📦 50/200 🏠 SE TA UV



NE



BI

**PI521 ISABELLE**

specchietto da borsa in plastica



📏 Ø 6 cm ca  
📦 100/500 🏠 SE TA UV



BI

BL



FX

NE

VE





RO

**PI525 JULIETTE**

spazzola con specchietto da borsa in plastica, astuccio







-  Ø 7 cm ca
-  50/200  SE TA UV

**PJ300 WIND**

ventaglio in poliestere e plastica



-  aperto: 43x23 cm ca  20/300
-  chiuso: 2,2x23 cm ca  SEUV



BI



GI



NE



RO



RY



VE

**PI360** SPRAY CAP

flacone spray in plastica, forma di penna  
capienza 10 ml, atomizzatore ricaricabile  
liquido non incluso



1,4x13 cm ca  
100/1000 SE TA



FLACONE  
SPRAY **10 ML**



VE

AZ

BL

BI

NE

RO

**PI210** LIFE

portapillole in plastica, 3 scomparti separati



7x2,5x2 cm ca  
50/1000 SE TA UV



VE



BL



BI

**PI225** PHARMA

portapillole in plastica, 3 scomparti separati



6,5x1,5x3,5 cm ca  
50/1000 SE TA UV



BI

**PJ200 CHAIR**

sedia pieghevole con custodia  
poliestere 600D



44xh69x44 cm ca

1/20 SE



BL



RO



## LAMPADA LED COB DA CAMPEGGIO

**PN391 CAMP LIGHT**

lampada da campeggio LED COB  
plastica, manici pieghevoli in metallo  
batterie non incluse, astuccio



chiusa: Ø 6,8xh9,5 cm ca

aperta: Ø 6,8xh13,5 cm ca

1/72 SE TA UV



BL



08.

PORTACHIAVI





**PE010 FINE HOUSE**

portachiaavi in metallo, anello piatto



4,5x5 cm ca

50/400 IN SE TA UV



RO



GR



VE



BL

**SPECIAL LASER**

Incisione a specchio

**PE012 LORIS**portachiaavi con fascia in poliuretano termovirante  
dettagli in metallo, 4 anelli in metallo, astuccio

Ø 1,7x7,5 cm ca

50/250 CA IN SE TA UV

astuccio  
regalo  
incluso**TERMovIRANTE**

BL



NE



RY



VE



RO



**PE029 CULT**

portachiaavi in ecopelle e metallo, astuccio



☑ Ø 3,5x6,5 cm ca  
 ☑ 50/250 ☑ IN SE TA UV



astuccio  
regalo incluso

**PE031 STRATO**

portachiaavi in ecopelle con cuciture a contrasto, anello in metallo cromato



☑ 3,5x8 cm ca  
 ☑ 100/500 ☑ IN SE TA



**PE095 SWEET HOME**

portachiaavi in metallo  
personalizzabile fronte/retro



3,6x3,6x0,5 cm ca  
50/500 IN SE TA UV

**PE096 BEETLE**

portachiaavi in metallo  
personalizzabile fronte/retro



4,1x3x0,4 cm ca  
50/500 IN SE TA UV

**PE100 RIO METAL**

portachiaavi in metallo cromato, frontale in acrilico, astuccio



Ø 3,5 cm ca  
50/250 IN (SI) SE TA UV



astuccio  
regalo incluso



**GANCIO  
APPENDIBORSA**

**PE001 HANGER**

gancio appendiborsa in metallo  
chiusura magnetica, astuccio



- ☐ Ø 4,5 cm ca
- 📦 50/200
- ⊕ IN (SI) SE TA



astuccio regalo incluso



AR



BI



NE



RO



RY



VE

**PE032 TEXAS**

portachiavi in alluminio  
fascia in poliestere, anello piatto



- ☐ 6,7x2,6 cm ca
- 📦 50/200
- ⊕ IN SE TA UV

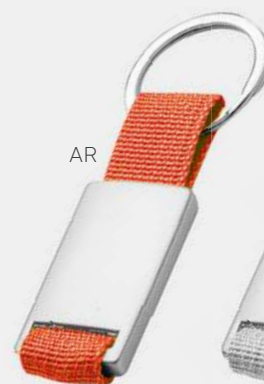

AR

BI

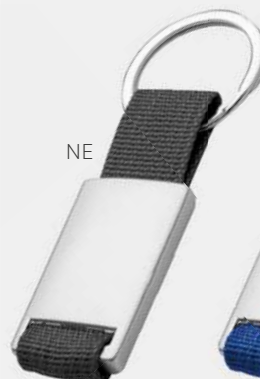

NE

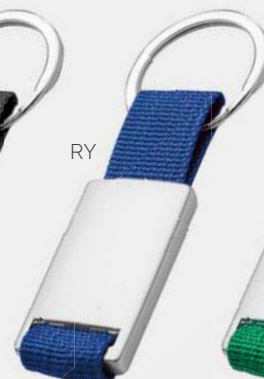

RY

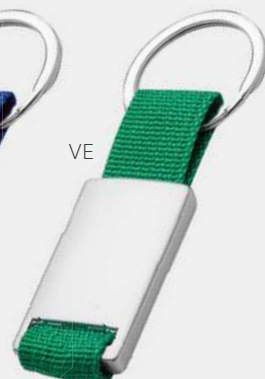

VE

### CA069 POCLETTE KEY

pochette portachiaavi in poliuretano bicolore  
catena portachiaavi, anello piatto in metallo  
chiusura con bottone, astuccio



9x8 cm ca  
1/100 CA IN SE



CAVALLARI  
STUDIO



### PE118 IMOLA

portachiaavi in plastica, gommino per touch screen



5,7x3,2 cm ca  
100/1000 SE TA UV



BI BL NE RO  
315

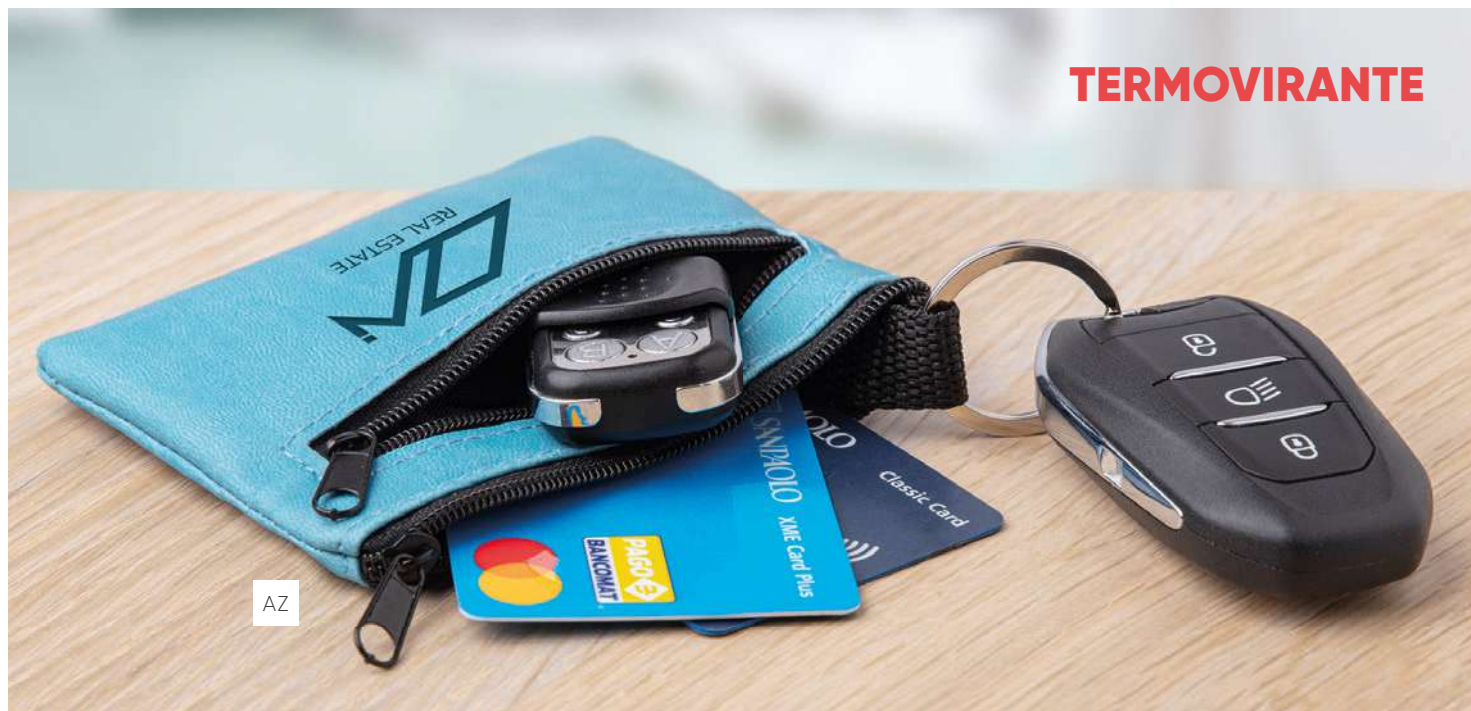

AZ

**PE033 FUNCTION**

portamonete in poliuretano termovirante, cerniera anteriore, tasca superiore, anello piatto portachiavi



11x8 cm ca

100/500 CA IN SE



AR



RO



BI



GI



NE



VE

## PORTACHIAVI CON GETTONE PER CARRELLO DELLA SPESA

Selezione di portachia-  
vi contenenti un gettone  
estraibile utile per  
sbloccare il carrello  
della spesa



### PE113 KARRY

portachia-  
vi magnetico in metallo, astuccio  
retro con gettone, frontale in acrilico



☐ Ø 3,5 cm ca

📦 50/200 🌐 IN (SI) SE TA UV



**GETTONE  
ESTRAIBILE  
PER CARRELLO**



RY



astuccio regalo incluso

### PE124 SMILE

portachivi in plastica, disco estraibile per carrello



2,6x6,5 cm ca  
100/1000 SE TA UV



### PE126 COIN

portachivi in plastica, disco estraibile per carrello



3x6 cm ca  
100/1000 SE TA UV







## SUSTAINABLE SELECTION

Portachiavi realizzati in materiali ecologici: legno, bamboo e sughero.



### PE067 ROT

portachiavi in legno, corpo circolare  
cordoncino colorato, anello piatto in metallo



4x0,2 cm ca

100/1000 IN SE TA UV



PORTACHIAVI  
IN LEGNO

### PE069 REC

portachiavi in legno, corpo rettangolare  
cordoncino colorato, anello piatto in metallo



5,5x3x0,2 cm ca

100/1000 IN SE TA UV



**PE060 TEXAS CORK**

portachiavi in alluminio  
fascia in sughero  
anello piatto in metallo



- 7x3 cm ca
- 50/300
- IN SE TA UV



NEW!

PORTACHIAVI  
IN SUGHERO



**PE078 TAO**

portachiavi in legno  
anello piatto in metallo  
due colori



- ∅ 4,5x0,3 cm ca
- 100/1000
- IN SE TA UV



NEW!

PORTACHIAVI  
IN LEGNO



**PE080 GAP**

portachiavi in bamboo, anello piatto in metallo  
supporto per smartphone



- 2,6x6x1,5 cm ca
- 100/500
- IN SE TA UV



BAMBOO



SUPPORTO  
IN LEGNO  
per smartphone



**PE075** ROOTS

portachiavi tondo in legno, anello piatto in metallo



☐ Ø 3,9x0,7 cm ca  
 ☐ 50/500 ☐ IN SE TA UV



 PORTACHIAVI  
IN LEGNO

**PE077** BRANCH

portachiavi rettangolare in legno, anello piatto in metallo



☐ 3,2x5,1x0,7 cm ca  
 ☐ 50/500 ☐ IN SE TA UV



 PORTACHIAVI  
IN LEGNO

**PE076** TRUCKportachiavi in legno  
anello piatto in metallo  
forma di veicolo, tre colori

☐ 7x3x0,5 cm ca  
 ☐ 100/1000 ☐ IN SE TA UV

**NEW!**

 PORTACHIAVI  
IN LEGNO

**PE079** VEHICLEportachiavi in legno  
anello piatto in metallo  
forma di automobile, due colori

☐ 6x2,7x0,2 cm ca  
 ☐ 100/1000 ☐ IN SE TA UV

**NEW!****PE076****PE079****NEW!**

Portachiavi in plastica trasparente  
parte superiore removibile  
cartoncino non incluso

01

Separa  
la base  
dalla parte  
superiore.



02

Stampa  
il tuo logo  
su cartoncino  
(non incluso)

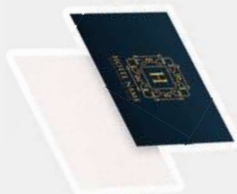

03

Richiudi  
a incastro  
la parte  
superiore  
trasparente.



### PE123 LABEL

portachiavi rettangolare



- 6,1x3,2 cm ca
- 100/1000
- SE TA UV



### PE136 ROUND LABEL

portachiavi circolare



- Ø 4,3 cm ca
- 100/1000
- SE TA UV



### PE137 LABEL OPENER

portachiavi apribottiglie



- 4,5x8,3 cm ca
- 1/500
- SE TA UV





**PE134 UTILITY OPENER**

portachiaavi in plastica, 1 metro  
apribottiglie in metallo, 1 led



8x3,2x0,8 cm ca  
10/200 SE TA UV



**PE143 GUINNESS**

portachiaavi apribottiglie in plastica



2,2x6,5 cm ca  
100/1000 SE TA UV





**PE138** KEY OPENER

portachiavi in metallo, apribottiglie



6x2,2 cm ca

50/500 IN SE TA UV



**PE144** ARX

portachiavi apribottiglie in metallo



0,9x7,9x1,5 cm ca

100/500 IN SE TA UV



### PE235 SKIZZO

portachivi con fascia in poliester  
moschettone di metallo in tinta



9x2 cm ca  
10/500 SE SU (BI IT)



moschettone  
in metallo



### PE133 TORCH KEY

portachivi torcia in plastica  
led alta luminosità



6,5x1,3 cm ca  
50/1000 TA UV



**PE358** PONENTE

portachiavi galleggiante in sughero  
corpo ovale, cordoncino colorato



4x9x1,5 cm ca  
1/500 SE IN UV



BL



VE

**PE359** ZEFIRO

portachiavi galleggiante in sughero  
corpo circolare, cordoncino colorato



7x1,5 cm ca  
1/500 SE IN UV



VE



BL



**PORTACHIAVI  
GALLEGGIANTE  
IN POLIURETANO**

**PE360** FLOATER

portachiavi galleggiante in poliuretano  
antistress, catena in metallo cromato



8x3,5x2 cm ca  
100/500 SE TA UV



BL



AR

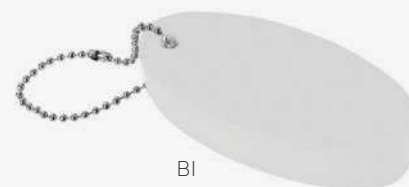

BI

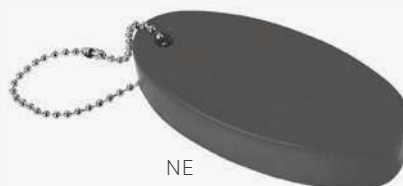

NE



RO



VE



VL



**PE392** MAISON

5x6 cm ca

**PE398** BATEAU

5,5x6,5 cm ca

**PE405** SURF

8,5x3,5 cm ca

## PORTACHIAVI GALLEGGIANTI MULTISTRATO

portachiaivi in EVA  
multistrato sagomato  
anello in metallo

100/500 SE TA UV

**PE401** ROUND

Ø 5 cm ca

**PE402** T-SHIRT

6x4,8 cm ca

# 09.

ACCENDINI  
E ACCESSORI





tubo orientabile

COLORI ASSORTITI  
confezione 5 colori diversi



**PE846 TURN**

accendigas in plastica e metallo  
tubo orientabile  
confezionato in colori assortiti



3x12 cm ca  
20/600 SE TA UV



**PE848 KITCHEN**

accendigas in plastica



3x10,5 cm ca  
SE TA UV  
SI 25/400  
BI-BL 25/500



**PE852 OPENER**

accendino in plastica, pietra focaia, funzione apribottiglie



2,4x8,7 cm ca  
50/1000 SE TA UV



BL



RO



BI



GI



NE



VE



**PE858 FLAMMY**

accendino in plastica, pietra focaia



2,3x8 cm ca  
50/1000 SE TA UV



AR BI BL GI NE RO VE

**PE859 VULCANO**

accendino in plastica, fiamma fissa



2,3x8 cm ca  
50/1000 SE TA UV

**ACCENDINO A FIAMMA FISSA**



BL BI GI NE RO SI

**PE863 FUEGO**

accendino piezoelettrico, plastica e metallo



- ☑ 2,3x8,7 cm ca
- ☑ 50/1000 ☒ SE TA UV

ACCENDINO  
**PIEZOELETRICO**

AR

BI

BL

NE

RO

VE

**PE864 BANG**

accendino piezoelettrico, plastica e metallo



- ☑ 2,4x8 cm ca
- ☑ 50/1000 ☒ SE TA UV

ACCENDINO  
**PIEZOELETRICO**

BI

BL

GI

NE

RO

SI

VE

**PE865 NEON**

accendino in plastica  
piezoelettrico  
colori assortiti



2,6xh8 cm ca  
50/1000 SE TA UV

COLORI  
ASSORTITI  
confezione 5  
colori diversi

**PE867 MAGMA**

accendino in plastica  
piezoelettrico  
confezione in colori assortiti



2,6xh8 cm ca  
50/1000 SE TA UV

**PE868 FLASH**

accendino piezoelettrico in plastica, torcia 1 led ad alta luminosità



2,4xh8 cm ca 50/1000  
SE TA UV



ACCENDINO CON  
**LUCE LED SUL FONDO**

tasto laterale per accensione

ACCENDINO  
**PIEZOELETRICO**



BI



BL



NE



SI

## POSACENERE TASCABILE E DA BORSA

una comoda soluzione per non  
danneggiare l'ambiente



### PE915 ASH

posaceneri in plastica  
con interno ignifugo  
tascabile e da borsa



8x8 cm ca

50/250 SE TA UV



BI



BL



AZ



GI



RO

10.

TECNOLOGIA

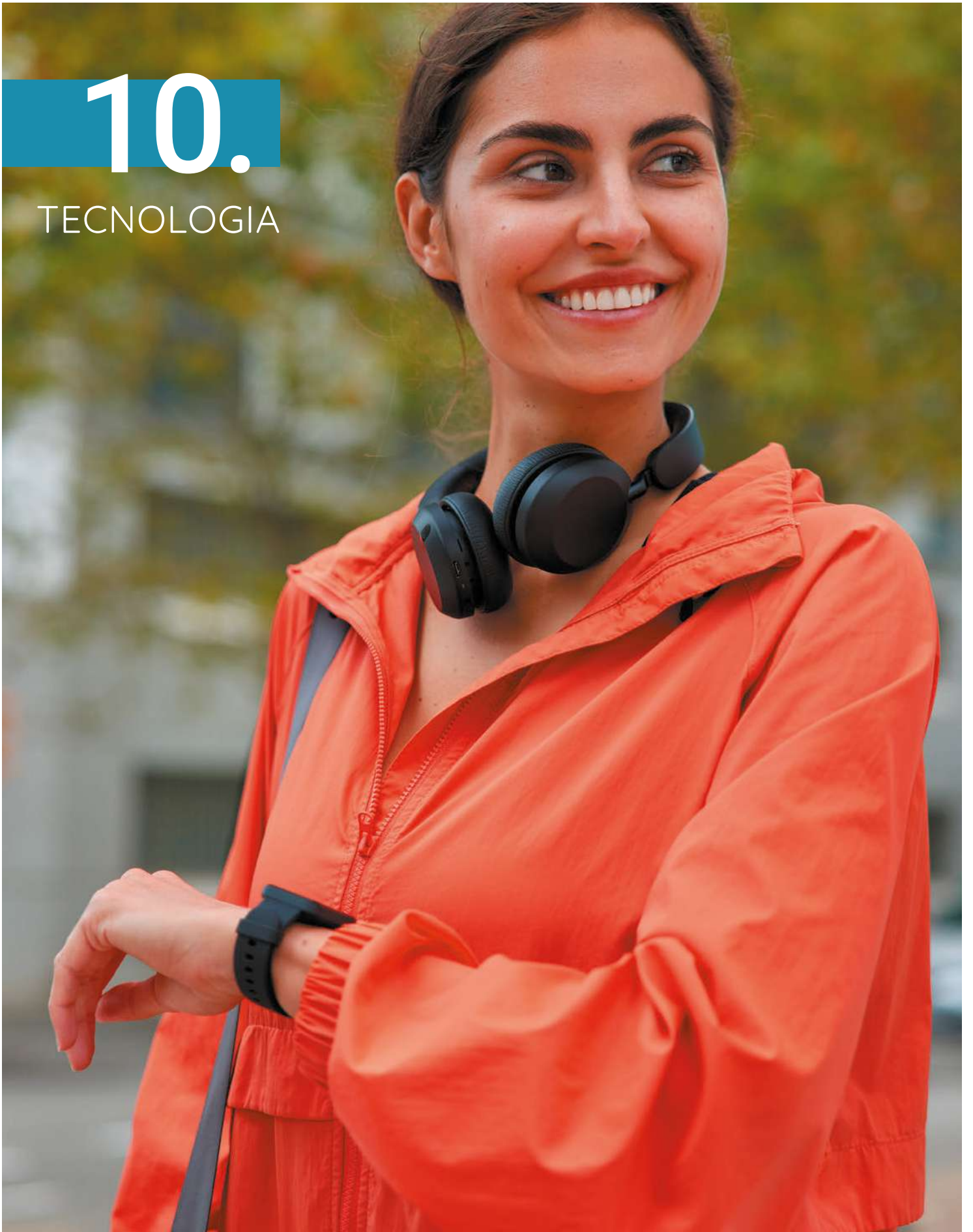



**PF191 CALLING**

smartwatch con cinturino in TPU  
funzione chiamate Bluetooth senza SIM  
schermo IPS 1,54", cornice in metallo, saturimetro  
pressione sanguigna, monitoraggio sonno  
contapassi, cardiofrequenzimetro, lettore musicale  
pressione sanguigna, telecamera remota, torcia  
funzione sveglia/allarme/cronometro



27x4x1,3 cm ca  
1/50 SE TA UV



base di  
ricarica  
inclusa

**PF190 ACTIVITY PLUS**

smartwatch con cinturino in TPU  
connessione Bluetooth  
schermo LCD 1,33 pollici touchscreen  
monitoraggio sonno, funzione sveglia  
water resistant, telecamera remota  
saturimetro, pressione sanguigna  
contapassi, cardiofrequenzimetro  
ricaricabile tramite usb  
compatibile con Android/iOS



25x3,6x1,3 cm ca  
1/50 SE TA



cinturino removibile  
dispositivo con USB per ricarica

**PF210 DAILY TIME PLUS**

smartwatch con cinturino in TPU, connettività bluetooth, batteria 180 mAh, interfaccia multilingue resistente all'acqua, schermo TFT 1,3



26x4,7x1,4 cm ca

1/50 SE TA



cavo di ricarica  
incluso



retro con  
sensore



## SPEAKER BLUETOOTH IN BAMBOO E RPET

**PF216 RPET SPEAKER**

speaker in bambù e RPET  
potenza 3W  
connessione Bluetooth 5.0  
cavo di ricarica Type-C incluso



Ø 5,3xh6,1 cm ca

1/50 IN TA UV



NEW!



## UMIDIFICATORE E STAZIONE METEO IN BAMBOO

 BAMBOO

PF279



 BAMBOO

PF187



### PF279 ESSENZA

diffusore di aromi ed oli essenziali  
umidificatore, capacità 130 ml  
1 intensità del vapore, cavo, astuccio



☑️ Ø 10x9,5 cm ca  
📦 1/50 🌐 IN TA



Umidificatore 130ml e diffusore di  
aromi con luci led

### PF187 METEOSAT

stazione meteorologica con fronte in bambù  
sensore di temperatura e umidità  
funzione calendario e sveglia  
supporto posteriore regolabile e pieghevole  
possibilità di installazione a parete  
alimentato a batterie (non incluse), astuccio



☑️ 13x13x2,4 cm ca  
📦 1/50 🌐 IN SE TA UV



Retro con  
pedino estraibile  
e foro fissaggio  
alle pareti



**PF289 BAMBOO SPEAKER**

speaker wireless in bamboo  
 connettività bluetooth, potenza 3w  
 ingresso micro sd, cavo incluso, astuccio



☑ Ø 7,3xh4,6 cm ca  
 ☑ 1/100 ☑ IN TA UV



**PF188 BAMBOO RADIO**



radiosveglia multifunzione in bamboo  
 antenna a scomparsa  
 alimentazione a batterie 2xAAA (non incluse)



☑ 12,5x8,5x4,7 cm ca  
 ☑ 1/50 ☑ IN SE TA UV



## BASI DI RICARICA WIRELESS IN BAMBOO



### PF266 BAMBOO RECHARGE

base di ricarica wireless in bamboo  
1 porta micro USB, cavo incluso, astuccio



Ø 10x0,7 cm ca  
1/100 IN SE TA UV



BAMBOO



### PF258 ROUND BAMBOO

base di ricarica wireless in bamboo  
cavo incluso, astuccio



Ø 9,1x0,9 cm ca  
1/100 IN SE TA UV



BAMBOO



### PF259 SQUARE BAMBOO

base di ricarica wireless in bamboo  
cavo incluso, 2 porte USB, astuccio



9,9x9x0,9 cm ca  
1/50 IN SE TA UV



**PF325 CHARGER ORGANIZER 2.0** 

organizer con caricatore wireless in bambù  
ricarica veloce 15 W  
supporto smartphone  
uscita USB da 2.000 mAh  
2 cariche simultanee



18,5x11,5xh1,4 cm ca  
1/50 IN SE TA UV

supporto per  
smartphone



BAMBOO

NEW!



base di ricarica wireless

## BASE DI RICARICA WIRELESS IN BAMBOO E RPET

**PF323 RPET CHARGER** 

caricatore wireless  
RPET e Bambù  
ricarica veloce 15W  
compatibile con tecnologia Qi  
protezione dal surriscaldamento  
cavo di ricarica Type-C incluso



9,5x9,5xh1 cm ca  
1/50 SE TA UV



BAMBOO



RPET  
ZERO  
SPRECHI



**PF333 CHARGER ORGANIZER 3.0**

organizer con caricatore wireless in bambù  
ricarica veloce 15 W, supporto smartphone e  
scomparto extra per oggetti, uscita USB  
2 cariche simultanee



## CARICATORE WIRELESS IN BAMBOO



- 25,5x1,5x13,5 cm ca
- 1/50
- IN SE TA UV



base di  
ricarica  
wireless



## SCALDATAZZA CARICATORE WIRELESS IN BAMBOO

**PF334 CHARGER CUP**

caricatore con scaldatazza in bambù  
compatibile con dispositivi dotati di tecnologia wireless Qi  
batteria wireless 10 W, connessione USB, cavo Type-C incluso



- 18x1,3x9,5 cm ca
- 1/50
- IN SE TA UV



**PF316 CRIB**

lampada con ricarica 10W wireless in bambù  
connessione Bluetooth, uscita USB,  
52 LED e 3 posizioni di illuminazione  
cavo Type-C incluso



23,5x18,5x8 cm ca  
1/20 IN SE TA UV



doppia funzione:  
lampada e caricatore wireless

**PF331 FOLDABLE CHARGER**

caricatore wireless 15W pieghevole in bambù  
e ABS compatibile con i dispositivi con ricarica  
Qi supporto telescopico integrato  
cavo di ricarica Type-C incluso



11x2,3x7,7 cm ca  
1/50 IN SE TA UV



base di ricarica wireless pieghevole e richiudibile





**PF170 RPET MOUSEPAD**  

tappetino mouse wireless in RPET e PU  
ricarica veloce 10W, cavo incluso  
supporto smartphone antiscivolo



26,5x20,5 cm ca  
1/50 TA UV

 **RPET  
ZERO SPRECHI**

Prodotto realizzato con poliestere  
riciclato nel rispetto della natura.



struttura pieghevole  
per uso supporto smartphone

**MOUSEPAD RPET CON CARICA VELOCE 10W****COMPUTER  
ASSISTANCE****PF330 CHARGER STAND** 

caricatore wireless pieghevole  
ricarica veloce 15 W simultanea per:  
smartphone, cuffie e smartwatch  
supporto per dispositivi



11x15,3x12 cm ca  
1/40 SE TA UV

base di ricarica  
smartphone

base di ricarica  
smartwatch

base di ricarica  
auricolari





BASI DI RICARICA WIRELESS

PF267 RECHARGE 7.0 

caricatore wireless in plastica, cavo incluso, astuccio



☑ Ø 10 cm ca  
 ☑ 1/200 ☑ SE TA UV



PF269 RECHARGE 5.0 

caricatore wireless in plastica, cavo incluso, astuccio



☑ Ø 7xh0,9 cm ca  
 ☑ 1/200 ☑ SE TA UV





PLASTICA  
RICICLATA



### PF183 TABS CHARGE ⚡

caricatore wireless 10W in ABS riciclato  
base di ricarica antiscivolo, cavo di ricarica



📏 10,6x1x7,3 cm ca

📦 1/100 🌐 SE TA

⚡ RICARICA WIRELESS  
VELOCE 10W



### PF314 R-ABS MOUSE

mouse wireless ottico in R-ABS  
batteria 500 mAh, bottone DPI, cavo incluso



📏 11,2x2,5x5,5 cm ca

📦 1/100 🌐 SE TA UV



PLASTICA  
RICICLATA



NEW!



cavo USB  
di ricarica  
incluso



ricevitore  
bluetooth  
incluso

**PF012 SOUND 5.0**

cuffie in plastica  
 ingresso jack 3,5 mm  
 struttura pieghevole  
 archetto 45x2,5cm ca  
 archetastuccio



16,5x18,6 cm ca  
 1/60 TA UV



**PF030 TOD**

auricolari con custodia in plastica, jack 3,5 mm  
 cavo 120 mm, tappo in silicone, moschettone



custodia: 2,6x11 cm ca  
 10/1000 SE TA UV





**AURICOLARI  
 JACK 3,5 MM  
 CON CUSTODIA**

**PF336 EAR PODS 5.3** 

auricolari connettività bluetooth 5.3, ricarica USB  
cavo Type-C incluso, custodia con batteria 300 mAh integrata  
pulsante di controllo integrato nell'auricolare

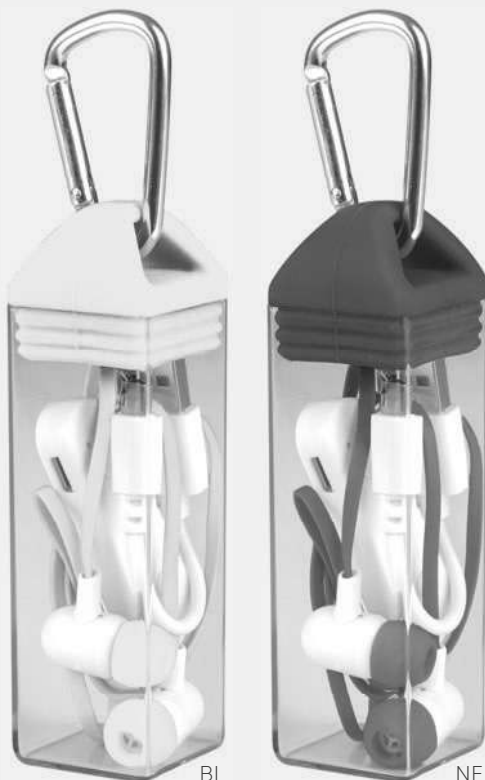
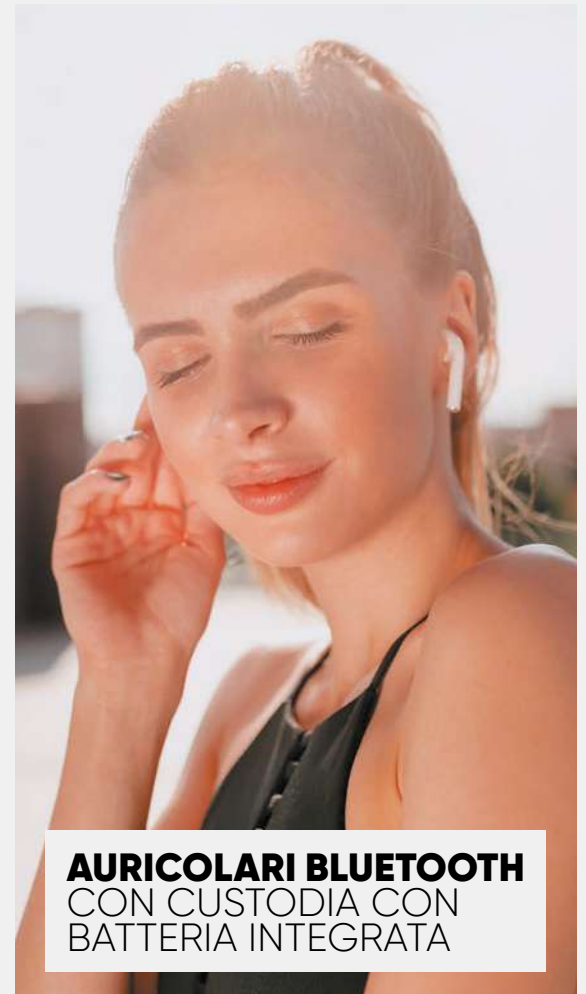

-  4,5x6,2x2,5 cm ca
-  1/100  SE TA UV

**PF016 EAR PODS 10.0**

auricolari bluetooth con custodia in plastica, cavo di ricarica, moschettone



-  custodia: 3x10x3 cm ca
-  1/200  SE TA UV



**AURICOLARI  
BLUETOOTH  
CON CUSTODIA**

# DOPPIO SET DI AURICOLARI CON CUSTODIA DI RICARICA

**PF337** DOUBLE EAR PODS 5.0  
 2 set di auricolari con custodia ricaricabile, batteria 300 mAh, connettività bluetooth 5.0 pulsante di controllo touch, indicatore di stato di carica, ricaricabile via USB



6x5,4x2,5 cm ca  
 1/100 SE TA UV



**NEW!**



Custodia con batteria integrata per ricarica degli auricolari



Custodia con doppio alloggiamento contenente due coppie di auricolari bluetooth

**PF277** EAR PODS 5.0 

auricolari, connettività bluetooth 5.0  
custodia con batteria integrata, cavo incluso



4,5x6,8x2,2 cm ca  
1/100 SE TA UV

Custodia con  
batteria integrata  
per ricarica  
degli auricolari

**PF256** EARPRO 

auricolari bluetooth, pulsante di controllo, ricarica USB  
base di ricarica, funzione vivavoce, cavo incluso



6x6,2x3,4 cm ca  
1/100 SE TA UV DI



Gommini di  
ricambio inclusi



Custodia con batteria  
integrata per ricarica  
degli auricolari





**SPEAKER**  
BLUETOOTH

**PF217 ABS SPEAKER**

speaker in ABS, Bluetooth 5.0, funzione radio, luci LED multicolore, cavo di ricarica Type-C incluso, potenza sonora 5W, slot scheda SD fino a 3 gb



10,1x15,5x5 cm ca

1/40 SE TA UV



porta USB



gancio integrato

**PF218 TWS SPEAKER**

speaker portatile con laccetto, bluetooth 5.0 e connessione jack da 3,5 mm LED multicolore, cavo di ricarica Type-C incluso, Potenza Sonora 5Wx2



Ø 7,5x18,6 cm ca

1/20 IN SE TA UV



connessione jack da 3,5 mm



tasti di controllo laterali



luce LED intercambiabile





**PF288 SHOWER**  

speaker wireless in plastica, potenza 3w, connettività bluetooth, cavo incluso impermeabile con ventosa, astuccio



Ø 8,5x5,5 cm ca  
1/50 TA UV



RO



**PF286 VOICE**

speaker wireless in alluminio, potenza 3w connettività bluetooth, cavo incluso, astuccio



Ø 5,9xh5 cm ca  
1/50 IN TA UV



**PF338 ABS SET POWER BANK**

Set caricatore, power bank e cavi accessori in ABS, custodia similpelle power bank 4000 mAh, 1 uscita di tipo C 20 W caricatore Q C3.0, ricarica rapida 18 W cavo micro USB/type c/lightning



14x4x9,5 cm ca  
1/40 SE TA UV



custodia da trasporto

NEW!



CARICABATTERIE DA PARETE  
**DOPPIA USCITA**

CAVO DI RICARICA ESTENSIBILE

POWERBANK  
**4.000 mAh**

**PF225 CREDITBANK**

powerbank in plastica, capacità 4000 mAh cavo integrato, micro USB-lightning, astuccio



10,5x6,9x1 cm ca  
1/100 SE TA UV



**4000 mAh**  
CON CAVO INTEGRATO

## POWERBANK PER SMARTPHONE E TABLET



## POWERBANK IN BAMBOO E RPET



**RPET**  
ZERO SPRECHI



**BAMBOO**



cavo Type-C incluso

### PF301 RPET & BAMBOO BANK

power bank in RPET e bambù, capacità batteria 5.000 mAh  
2 uscite USB, doppio ingresso/uscita Type-C, cavo di ricarica di tipo C



13,1x7x1,8 cm ca  
1/50 SE TA UV

**5.000 mAh**



### PF304 ALU BANK

power bank in alluminio, batteria 4000 mAh  
uscita USB e ingresso Micro USB, cavo incluso  
indicatori di stato di carica a LED



11x6,8x1 cm ca  
1/50 SE TA UV



**4.000 mAh**







**POWERBANK  
PER SMARTPHONE  
E TABLET**

**PF307 5 CONNECTIONS BANK**  

power bank in alluminio, batteria 10.000 mAh  
uscita USB con due cariche contemporanee  
triplo ingresso: lightning, Micro USB e type-C  
indicatori di stato di carica a LED



-  14x7,5x1 cm ca
-  1/50  SE TA UV





LIGHTNING MICRO USB TYPE C USB 1 USB 2

**PF306 ALU RECYCLED BANK**

power bank in alluminio riciclato, capacità batteria 4000 mAh  
2 uscite USB e doppio ingresso e uscita Type-C  
indicatori di stato di carica a LED, cavo incluso



-  13x6,5x1,1 cm ca
-  1/50  SE TA UV



NE



BL



RO



SI

**POWEBANK  
4000 MAH  
IN ALLUMINIO  
RICICLATO**





**PF203 POWER LIGHT**  
powerbank in plastica, 1 luce LED  
capacità 10000 mAh, astuccio



14,3x6,5x2,2 cm ca  
1/40 SE TA UV

**10000 MAH  
CON TORCIA**



RO

BL

GR

VE

BI

**PF024 RETRACHT**

cavi di ricarica in plastica 3 in 1  
sistema con cavo retrattile, cavo 1 m



∅ 4 cm ca  
1/500 SE TA UV



AZ

IPHONE

MICRO  
USB

TYPE C



**CAVI DI  
RICARICA  
4 IN 1**



BI

NE

VL

**PF026 CABLE KNIFE**

cavi di ricarica in plastica 4 in 1



9,2x2x1,5 cm ca  
1/500 SE TA UV



**CAVI DI  
RICARICA  
4 IN 1**

**PF029 CONNECTION**

cavi di ricarica in plastica 4 in 1  
lunghezza cavi 12 cm



2,7x18 cm ca  
10/200 SE TA UV

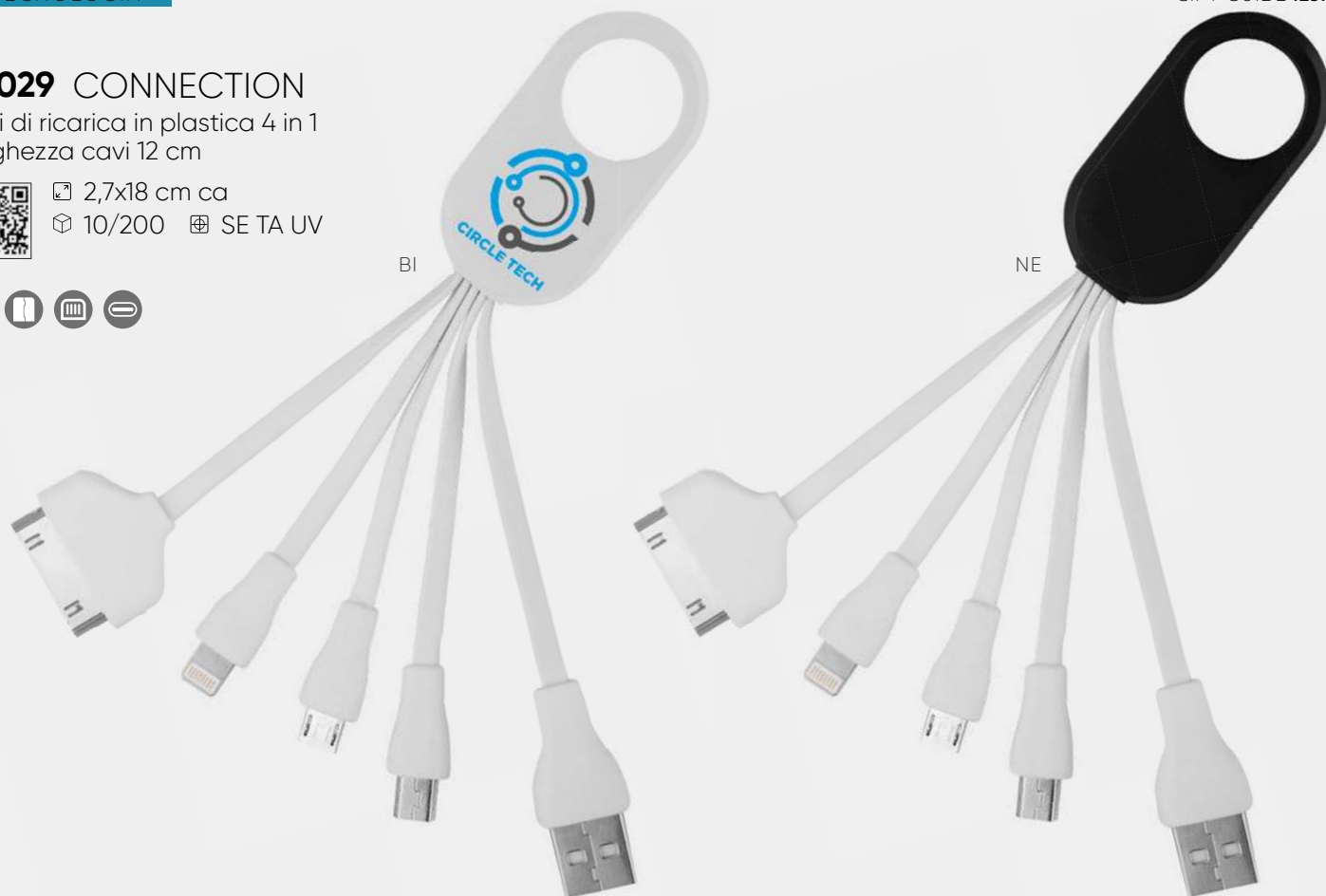

**PF525 CABLE CUBE**

cavi di ricarica in plastica 2 in 1  
supporto per smartphone



3x4,3 cm ca  
50/400 SE TA UV



**CAVI DI RICARICA 2 IN 1**  
MICRO USB - LIGHTNING



### PF602 STAND

supporto per cellulare  
plastica e metallo  
elastico per grip  
alette pieghevoli  
adesivo sul retro



2,2x7,4 cm ca  
10/1000 SE



BI

BL

NE



**ELASTICO  
PER GRIP**



**SUPPORTO PER  
SMARTPHONE  
CON RETRO  
ADESIVO**

### PORTACHIAVI CAVI DI RICARICA

Compatibili con dispositivi  
iPhone e Android

### PF515 CABLE TAG

cavo di ricarica 3 in 1 in plastica



2,5x4,5 cm ca  
50/1000 SE TA UV



LIGHTNING



TYPE C

targhetta  
personalizzabile



RO

adattatore  
a USB type C  
da lightning  
micro USB



AR

BI

NE

VL

**MEMORIA USB  
IN PLASTICA  
E METALLO  
CORREDATA  
DI ASTUCCIO  
DI ASTUCCIO**



**PF104-04 MEMORY 4**

capacità 4 GB



5,5x1,91x0,7 cm ca  
1/1 IN SE TA UV



AR



BL



NE



VE

**PF104-08 MEMORY 8**

capacità 8 GB



5,5x1,91x0,7 cm ca  
1/1 IN SE TA UV



BI



GI



RO



VI

**PF108-04 PEN DRIVE**

memoria USB in plastica e metallo  
capacità 4 GB, astuccio  
penna a sfera in lacca lucida  
inchiostro nero



14x1,4 cm ca  
1/1 SE TA UV



BI

NE

**PF106-04 PASSEPARTOUT**

memoria USB in plastica  
capacità 4 GB, astuccio incluso



5x8,2 cm ca  
1/1 SE TA UV

**MEMORIA USB  
PERSONALIZZABILE  
CON STAMPA UV**



**MEMORIA USB 4 GB  
E PENNA A SFERA**



## RICHIEDI LA TUA PENNA USB CON STAMPA PERSONALIZZATA



US001



US002



US003



US004



US005



US006



US007



US008

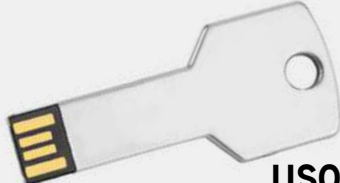

US009



US010



US011



US012



US013



11.

ACCESSORI  
AUTO E  
BRICOLAGE

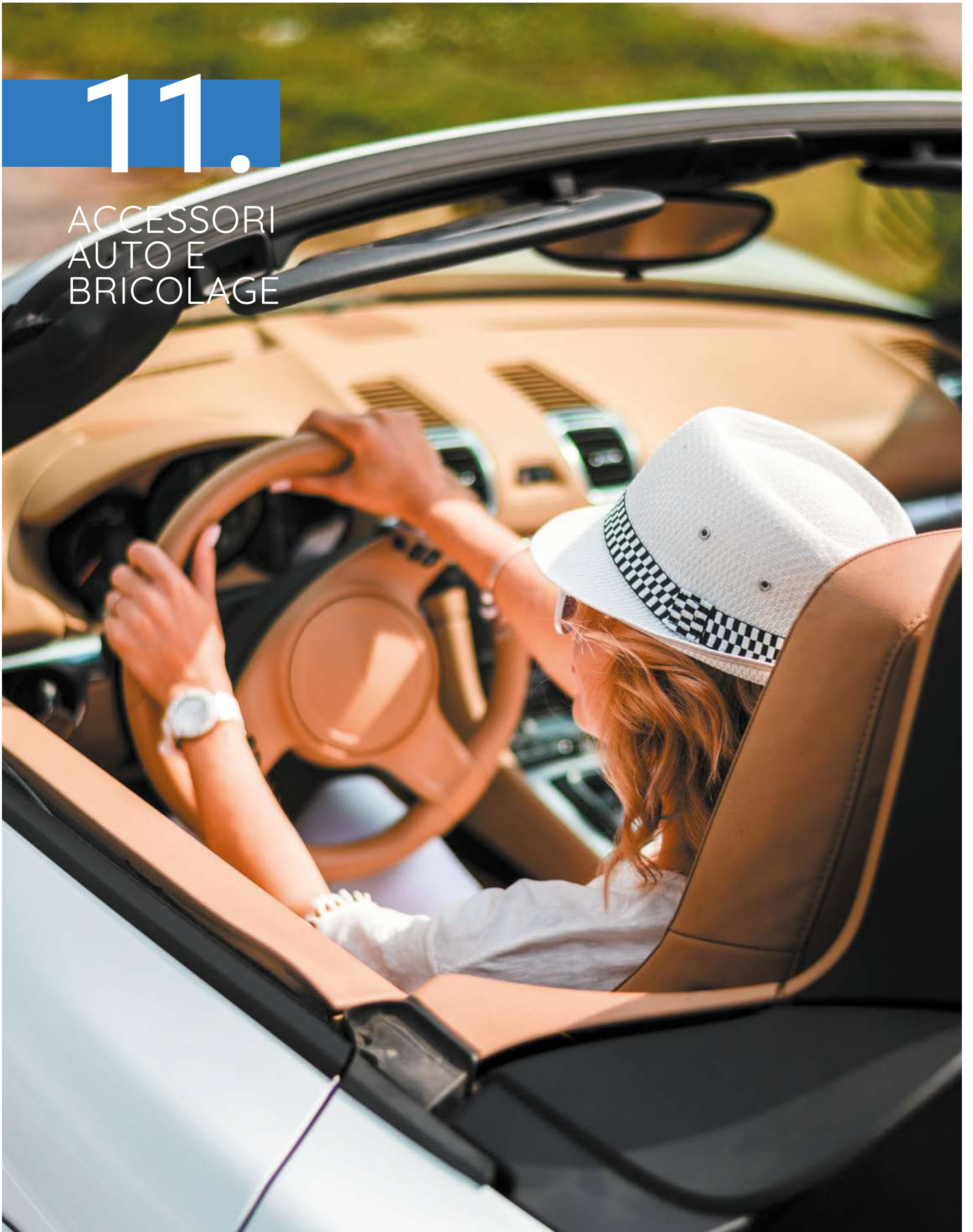

**PN057 GRIP**

portacellulare in plastica, base con ventose



☑ Ø 6 cm ca  
 ☐ 50/250 ☒ SE TA UV



BI



SI



NE

**SUPPORTO  
CON VENTOSE****SUPPORTO  
MAGNETICO****PF387 FLEX CAR**supporto orientabile per cellulare  
plastica e metallo  
adesivo magnetico

☑ 3,5x5 cm ca  
 ☐ 1/200 ☒ TA UV



Adesivo magnetico  
da applicare sul  
retro dello smartphone



BL

SI

### PF389 MAGNET CAR

supporto per cellulare in plastica e metallo  
adesivo magnetico



3,3x3 cm ca  
1/200 TA UV



Adesivo magnetico  
da applicare sul  
retro dello smartphone

### PN053 CHARGEUR

caricatore auto in plastica e metallo  
uscita USB 1000 mA



2,4x5,5 cm ca  
120/600 TA UV



NE

BI



### PN045 FLAT

caricatore auto, plastica e metallo  
uscita USB 1000 mA



3,2xh6,2x4,6 cm ca  
100/500 SE TA UV



BI



NE



BL

Ampia  
superficie  
personalizzabile

# PORTADOCUMENTI IN SIMILPELLE



**PN060 AUSTRALIA**  
portadocumenti in similpelle  
chiusura con bottone



19,5x13,2 cm ca  
50/100 SE UV



BL



BS

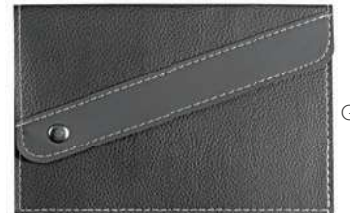

GR



MA



NS



RO



RY

BY

**PN065 CODE**

portadocumenti in pvc  
chiusura con pattina  
marcatatura neutra a secco



- ☑ 19x13 cm ca
- 📦 50/100
- ⊕ SE UV

**PORTADOCUMENTI  
CON MARCATURA  
A SECCO**



BL



BO

MA

NE

RO

**PN085 IDEA**

portadocumenti in pvc, chiusura con bottone



- ☑ 18x13,7 cm ca
- 📦 20/600
- ⊕ SE UV



RY



BI

BL

GR

RO

VE

# CAVALLARI STUDIO

**CA065** POCLETTE SMALL  
borsello portadocumenti in poliuretano  
bicolore con interno a contrasto  
chiusura con bottoni a pressione  
astuccio Cavallari Studio



23x15,5 cm ca  
1/50 CA IN SE



BC

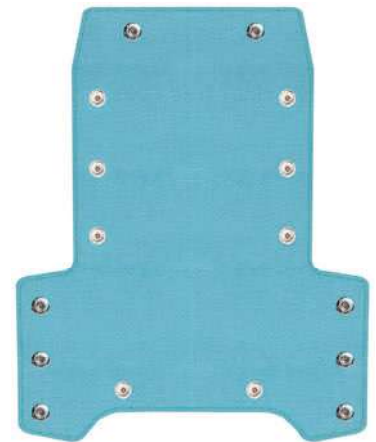

Struttura apribile  
interamente



BC



BO



GR



MC



MR



NR

### PN083 MONACO

portadocumenti auto in tam, 3 ante, 3 ante, varie tasche interne



aperto: 42x19 cm ca    chiuso: 13x19 cm ca  
 25/250    SE UV



BL



GR



NE

### PN086 BAHRAIN

portadocumenti in tam, 4 schede estraibili



19x15,5 cm ca  
 25/100    SE UV



BL



GR

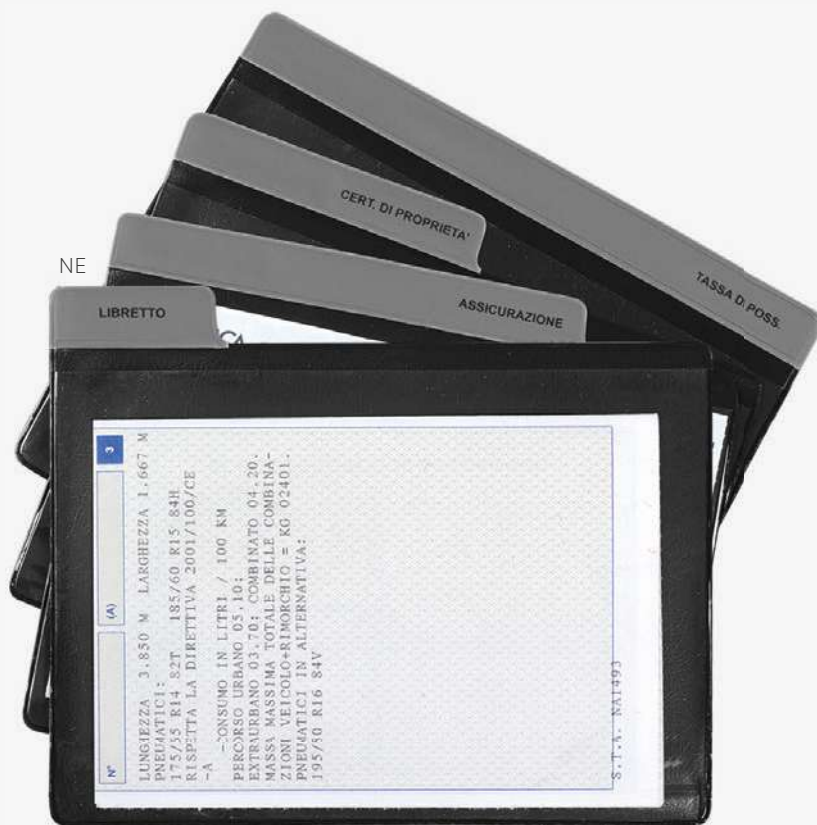

NE



### PN098 DENVER

portadocumenti auto in tam, bottone



18,7x13 cm ca  
25/100 SE UV



AR

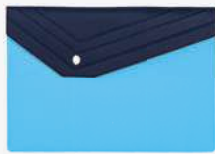

AZ



BU

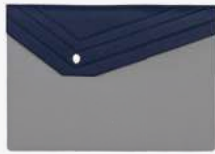

GR



RO



VE



VL



BL

### PN101 INDIANAPOLIS

portadocumenti in similpelle, chiusura con bottone



13x16,5 cm ca  
50/300 SE UV



RO



AR



AZ



BL



BU



GI



GR



VE



VL



PORTA  
DOCUMENTI  
**AUTO IN TAM**

**PN102 ABU DHABI**  
portadocumenti auto in tam  
chiusura con pattina



18,3x13 cm ca  
20/100 SE UV



AR



AZ



BL



BU



FX



GI



GR



RO



VL

**PN150 SNAP**  
portadocumenti in pvc



☑ 25,5x18,5 cm ca  
☑ 100/500 ☑ SE UV



BI



VE

BL



**PN151 BILL**  
portadocumenti in pvc



☑ 13x18 cm ca  
☑ 10/1000 ☑ SE UV

VE



BI



BL



## DISCHI ORARI MULTIFUNZIONE MAXI E MINI

### PN158 STEP

disco orario multifunzione in plastica  
lama in metallo per  
taglio cintura di sicurezza  
portabiglietto di parcheggio sul retro  
retro con gettoni per carrello  
in misure diverse



11x15 cm ca  
50/100 SE TA UV



tre gettoni estraibili di differenti misure  
per lo sblocco del carrello spesa



lama di emergenza per taglio della cintura di sicurezza



portaticket del parcheggio in finestra posteriore



### PN154 TIME

disco orario maxi in cartone  
custodia trasparente in pvc



11,5x15 cm ca  
25/500 SE UV



doppia  
faccia  
fronte/retro

### PN153 PARKING

disco orario mini in cartone, pvc adesivo  
rotella in cartone rigido, fogli interi da 8 con foratura



7,3x11,5 cm ca  
96/2504 SE UV

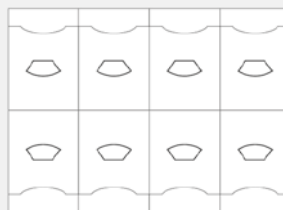

fornito in  
fogli interi da 8  
con foratura

### PN156 PERIOD

disco orario multifunzione in plastica  
raschiaghiaccio, spatola in gomma  
retro con gettone per carrello  
misuratore usura battistrada



12x15,5 cm ca  
50/100 SE TA UV



strumento per la misurazione  
dell'usura dei pneumatici



gettone estraibile per lo  
sblocco del carrello spesa



**PORTATARGA  
AUTO CON  
FISSAGGIO  
UNIVERSALE**

**PN200 KIT**

kit fermatarga in resina resistente  
compatibile con gli articoli:

PN204 PN212

2 graffette antivibrazione

3 bottoni fermatarga blu

1 bottone fermatarga bianco



100/100



**3 BOTTONI  
FERMATARGA  
BLU**



**1 BOTTONE  
FERMATARGA  
BIANCO**



**2 GRAFFETTE  
ANTIVIBRAZIONE**



**PN204 CASH ALLUMINIUM**

portatarga anteriore auto  
alluminio verniciato



37,5x13,5 cm ca

100/100 SE UV

**KIT PN200  
SU RICHIESTA**



**PN212 BOND**

portatarga posteriore auto alluminio antiossidante



52x13,5 cm ca

100/100 SE UV

**KIT PN200  
SU RICHIESTA**



**PN210 PLUM**

portatarga anteriore auto  
alluminio antiossidante



37x13,5 cm ca  
100/100 SE UV

**PN215 TRIM**

portatarga posteriore auto in plastica antiurto, montaggio con viti o rivetti (non inclusi)



52x13,5 cm ca  
100/100 SE UV

**PN220 MCQUEEN**

portatarga posteriore auto  
polipropilene alta resistenza  
montaggio con bottoni fermatarga inclusi  
listello di colore argento fornito smontato



52,5x13,5 cm ca  
100/100 SE UV



LISTELLO FORNITO **SMONTATO**



**PN201 ARMOR**

portatarga posteriore auto in acciaio verniciato



53,5x13,5 cm ca  
1/100 SE UV

**PORTATARGA PER AUTO  
IN ACCIAIO VERNICIATO**

NF

**PN203 CASH**

portatarga anteriore auto acciaio verniciato



37,5x13,5 cm ca  
100/100 SE UV

NE

**PN226 DRILLED**

portatarga posteriore auto in polipropilene alta resistenza, montaggio con viti o rivetti non inclusi



52x13,5 cm ca  
50/50 SE UV

NE

**PN227 STIFF**

portatarga anteriore auto polipropilene alta resistenza



36,5x13 cm ca  
100/100 SE UV

NE





## PORTATARGA MOTO E SCOOTER CON FISSAGGIO UNIVERSALE



### PN208 MASSY

portatarga moto  
alluminio antiossidante



19,5x23 cm ca  
100/100 SE UV

### PN228 VEZA

portatarga scooter  
plastica antiurto



15,3x15 cm ca  
100/100 SE

### PN230 MOTID

portatarga moto  
polipropilene alta resistenza



18,5x21 cm ca  
100/100 SE

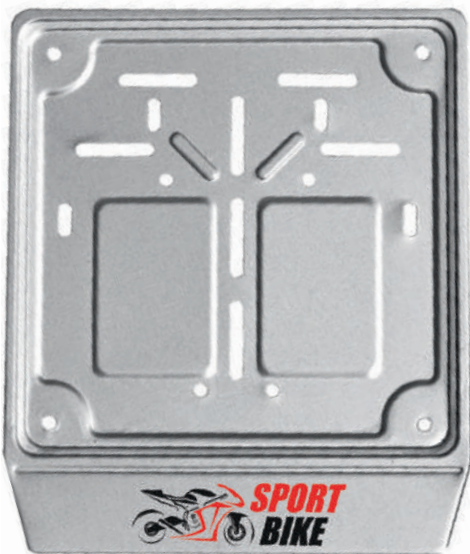

PORTATARGA MOTO  
ALLUMINIO ANTIOSSIDANTE



PORTATARGA SCOOTER  
PLASTICA ANTIURTO



PORTATARGA MOTO  
POLIPROPILENE ALTA  
RESISTENZA

### PM824 SAFETY JACKET

gilet di sicurezza 100% poliester, profili rifrangenti



65x65 cm ca  
10/100 SE TR



GI



AR

### PN265 FRAME

panno autoin microfibra



30x35 cm ca  
10/500 SE



GI





# PORTACARD RFID



portacard in tam  
protezione RFID  
interno bicolore

## PN268 BANCOMAT

10 tasche



7,5x10,3 cm ca  
23/350 SE UV



AR

BL

NE

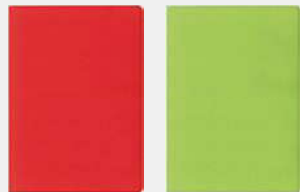

RO

VL



## PN269 BASIC CARD

2 tasche



5,5x9,5 cm ca  
50/800 SE UV



AR

AZ

BL

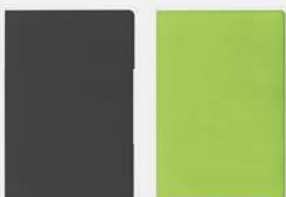

NE

VL



RO



### PN264 WHEAT CARD

porta card in paglia di frumento  
protezione RFID



9x6x0,5 cm ca  
100/1000 SE TA UV



PAGLIA DI FRUMENTO



### PH482 SAVE CARD 7

portacard in alluminio, capienza 7 cards, protezione RFID



6,2xh9,5x0,8 cm ca  
50/200 SE TA UV



BL

GR

SI



### PN270 TARJETA

portapatente in pvc  
portacards 3 ante



6,5x9,5 cm ca  
100/1000 SE UV



BL



NE



RO



RY



SI

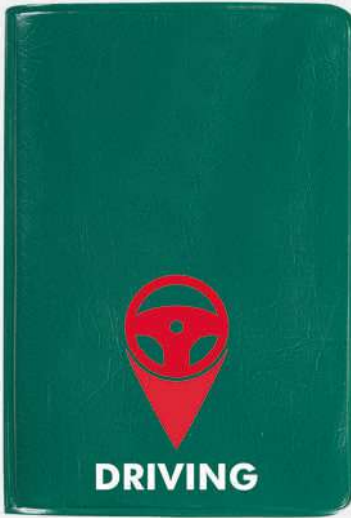

VE



### PN272 TAMMY

portapatente in tam  
portacards 3 ante



6,5x9,5 cm ca  
100/1000 SE UV



AZ



RO



SI



VE



BL



**PN273 FORM**

portapatente in pvc, portacards 6 ante



6,5x9,5 cm ca  
50/500 SE UV



BI



BL



NE



RO



RY



SI



VL

**PORTACARD IN PVC  
INTERNO 6 ANTE**



VE

**PORTACARD IN TAM  
INTERNO 6 ANTE**



BL

**PN274 FIDELITY**

portapatente in tam  
portacards 6 ante



7,5x10,3 cm ca  
50/500 SE UV



AZ

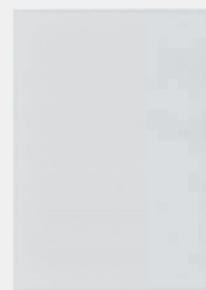

BI



RO



VE

### PN279 CHART

portapatente in pvc, portacards 1 tasca



9,5x6,5 cm ca  
102/1428 SE UV



TR

### PN280 LICENSE

portapatente in tam, portacards 1 tasca



9,5x6,5 cm ca  
50/1200 SE UV



AR

BI

BL

VE

RO



### PN284 FIRM

portacards rigido in plastica trasparente



9x6 cm ca  
200/1000 SE TA UV



BL

RO

TR



GI

### PN281 CARD

portapatente in pvc  
capienza 2 cards



6,2x9,5 cm ca  
120/960 SE UV



BI



BL



NE



RO



SI



VE



VL



RY



AZ



### PN282 BRIDGE

portapatente in tam  
capienza 2 cards



6,2x9,5 cm ca  
100/500 SE UV



AR



BI



BL



RO



VE



**PN330 WOOD MET**

doppio metro premium quality in faggio/carpine  
verniciatura in UV, finitura multistrato con rivetti in acciaio  
resistente all'abrasione e agli agenti atmosferici  
giunti a snodo in poliammide nascosti  
stecche strette, dritte e lisce



☑ 23,5x3,3 cm ca  
☑ 10/100 ☑ SE TA UV

**PN351 TANGANIK**

doppio metro monocolor in legno, aste strette



☑ 23,5x3,2 cm ca  
☑ 12/120 ☑ SE UV

**PN353 FIR**

doppio metro bicolor in legno, aste strette



☑ 23,5x3,2 cm ca  
☑ 12/120 ☑ SE UV

**PN354 TOUGH**

doppio metro in plastica



☑ 23,5x3,2 cm ca  
☑ 10/100 ☑ SE UV



## ROLLINE E STOP MASTER



### PN300 ROLLY

rollina in plastica e metallo, lunghezza 20 m, corredato di astuccio



☐ Ø 13 cm ca  
☐ 1/50 ☐ SE TA UV



SY



NE



SI

## STOPMASTER

stopmaster in plastica e metallo,  
clip in metallo, guaina in gomma  
corredato di astuccio

### PN362 LONG 5

lunghezza 5 m



☐ 6,5x7 cm ca  
☐ 10/60 ☐ SE TA UV

### PN364 LONG 3

lunghezza 3 m



☐ 6x6,5 cm ca  
☐ 10/120 ☐ SE TA UV



**PN387 CUTTY SOLID**

taglierino in plastica e metallo  
lama a sezioni, tasto per bloccaggio



3x15 cm ca  
100/600 SE TA UV



BI

BL

GI

RO

**PN388 CLAPPY**

taglierino in plastica e metallo  
lama a sezioni, tasto per bloccaggio



3x16,5 cm ca  
10/100 SE TA UV

**PN450 ST. JOSEPH**

matita carpentiere in legno, fornita non temperata



1,1xh17,5 cm ca  
100/1000 SE TA UV



matita fornita  
non temperata



# 12.

OMBRELLI E  
IMPERMEABILI



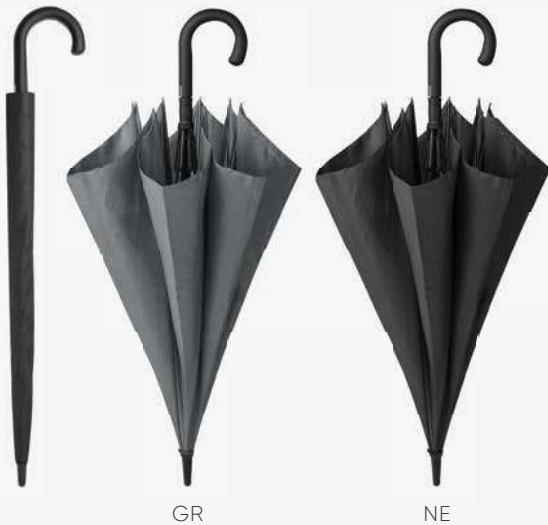

GR

NE

## CA600 SHELTER

maxi ombrello automatico in poliestere pongee  
struttura in fibra di vetro, chiusura con velcro  
fusto e puntale in metallo nero  
fusto disegno fibra di carbonio  
custodia in colore abbinato



☑ Ø 120xh93 cm ca ☑ 10/30  
☑ fusto: Ø 1,2 cm ca ☑ SE TR



struttura rinforzata  
in fibra di vetro

BL

logo Cavallari  
sul manico

cavallari



altezza:  
cm 93



diametro:  
cm 120



apertura:  
automatica

MAXI



AR

AZ

BL

GI

VE

BI



## PL091 ROOF

maxi ombrello automatico in nylon taffetà 170T  
manico bicolore in eva chiusura con velcro  
fusto e puntale in metallo nero  
struttura in fibra di vetro



☑ Ø 125xh93 cm ca ☑ 10/30  
☑ fusto: Ø 1,4 cm ca ☑ SE TR



manico  
bicolore

RO

struttura rinforzata  
in fibra di vetro



altezza:  
cm 93



diametro:  
cm 125



apertura:  
automatica

MAXI



altezza:  
cm 103



diámetro:  
cm 135



struttura  
antivento



apertura:  
automatica



NEW!

### PL085 AUTOM

ombrello automatico in poliestere pongee  
fusto e struttura in fibra di carbonio  
antivento, chiusura in velcro  
manico in EVA



- ☐ Ø 135xh103 cm ca    ☐ 10/20
- ☐ fusto: Ø 1,4 cm ca    ☐ SE SU (BI) TR



fusto in  
fibra di  
carbonio



struttura rinforzata  
in fibra di vetro  
e antivento



### PL089 MADERA

ombrello automatico in RPET  
 struttura in fibra di vetro  
 chiusura con velcro  
 fusto e puntale in legno impermeabilizzato  
 manico in legno con finitura opaca



☑ Ø108xh88,5 cm ca ☑ 10/30  
 ☑ fusto: Ø1,4 cm ca ☑ SE TR



RO

OMBRELLO  
 REALIZZATO  
**IN PET RICICLATO**



**RPET  
 ZERO  
 SPRECHI**



altezza:  
 cm 88,5



diametro:  
 cm 108



apertura:  
 automatica



RY

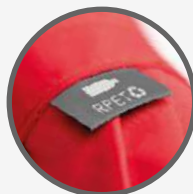

label RPET

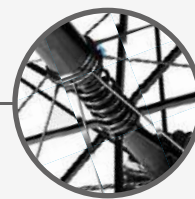

struttura rinforzata  
 in fibra di vetro



AR

BL

GR

RY

VE

BI



### PL087 BOIS

ombrello automatico in nylon taffetà 170T  
 struttura in fibra di vetro, chiusura con velcro  
 fusto e puntale in legno impermeabilizzato  
 manico in legno con finitura opaca



☑ Ø108xh88,5 cm ca ☑ 10/30  
 ☑ fusto: Ø1,4 cm ca ☑ SE SU (BI) TR



altezza:  
 cm 88,5



diametro:  
 cm 108



apertura:  
 automatica



BO

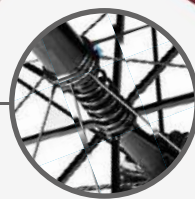

struttura rinforzata  
 in fibra di vetro



BI



BO

VE



altezza:  
cm 93



diametro:  
cm 125



apertura:  
automatica

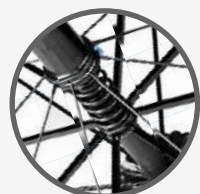

struttura rinforzata  
in fibra di vetro



manico  
traforato

BL

### PL105 PLATA

maxi ombrello automatico  
nylon taffetà 170T, profilo a contrasto  
fusto e puntale in metallo  
manico traforato  
struttura in fibra di vetro  
chiusura con velcro



- ☑ Ø 125xh93 cm ca ☑ 10/30
- ☑ fusto: Ø 1,4 cm ca ☑ SE SU (BI) TR



SI-GR

SI-BL



altezza:  
cm 88,5



diametro:  
cm 105



apertura:  
automatica

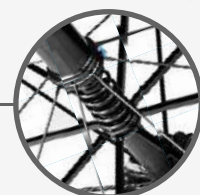

struttura rinforzata  
in fibra di vetro

SI-BO

### PL102 LUNAR

ombrello automatico in nylon taffetà 170T  
fusto, manico e puntale in alluminio  
struttura in fibra di vetro, chiusura con velcro



- ☑ Ø 105xh88,5 cm ca ☑ 10/30
- ☑ fusto: Ø 1,4 cm ca ☑ SE TR





altezza:  
cm 93



diámetro:  
cm 125



apertura:  
automatica



## PL107 ZEUS

maxi ombrello automatico  
nylon taffetà 170T, manico in eva  
fusto e puntale in metallo nero  
struttura in fibra di vetro  
chiusura con velcro



☑ Ø 125xh93 cm ca ☑ 10/30  
☑ fusto: Ø 1,4 cm ca ☑ SE SU (BI) TR





altezza:  
cm 93



diametro:  
cm 125



apertura:  
automatica

MAXI

**PL109 MOONY**

maxi ombrello automatico in nylon taffetà 170T  
manico in eva, fusto e puntale in metallo nero  
struttura in fibra di vetro, chiusura con velcro



- ☐ Ø 125xh93 cm ca ☐ 10/30
- ☐ fusto: Ø 1,4 cm ca ☐ SE TR

struttura rinforzata  
in fibra di vetro



altezza:  
cm 83



diametro:  
cm 105



apertura:  
automatica

**PL124 SHINE**

ombrello automatico in nylon taffetà 170T  
struttura in fibra di vetro, chiusura con velcro  
manico e puntale in plastica silver



- ☐ Ø 105xh83 cm ca ☐ 10/30
- ☐ fusto: Ø 1 cm ca ☐ SE TR

struttura rinforzata  
in fibra di vetro

## SPECIALE SUBLIMAZIONE

La sublimazione garantisce un'ottima resa di stampa permettendoti di non avere limiti nella scelta di colori e soggetti.

### PL112 SUBLI RAIN

ombrello automatico in nylon taffetà 170T  
fusto in metallo, manico in eva  
struttura in fibra di vetro, chiusura con velcro  
puntale e bordino colorati



☑ Ø 105xh83 cm ca ☑ 10/30  
☑ fusto: Ø 1 cm ca ☑ SE SU TR



altezza:  
cm 83



diámetro:  
cm 105



apertura:  
automatica



SU  
BLI

SE  
SU  
TR

SE  
SU  
TR



struttura rinforzata  
in fibra di vetro

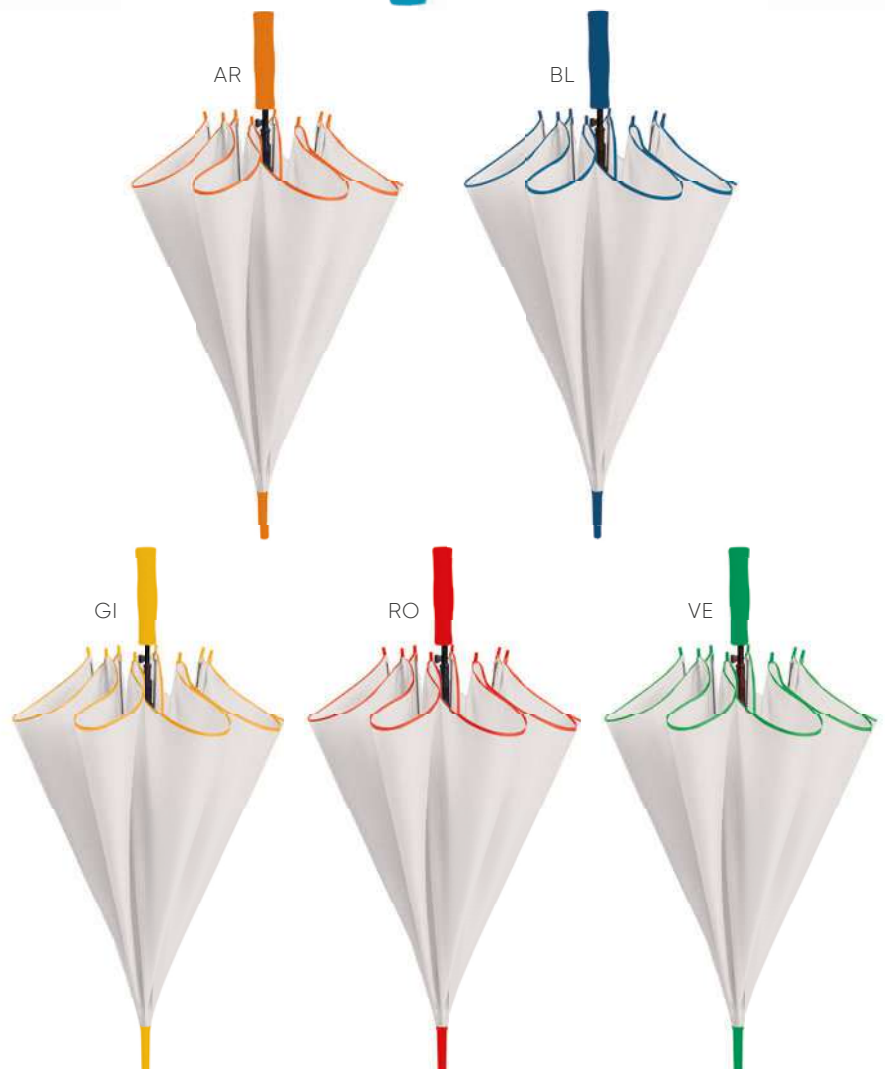



altezza:  
cm 84



diámetro:  
cm 105



apertura:  
automatica



struttura  
antivento

### PL113 DAILY

ombrello automatico in poliestere pongee  
struttura in fibra di vetro, antivento  
chiusura in velcro, fusto in metallo



☑ Ø 105xh84 cm ca ☑ 10/30

☑ fusto: Ø 1,4 cm ca ☑ SE SU (BI) TR





altezza:  
cm 81,5



diametro:  
cm 105



apertura:  
automatica

## PL119 ACTIVE

ombrello automatico in nylon taffetà 170T  
puntale in plastica nera  
fusto in metallo, manico in eva  
struttura in fibra di vetro  
chiusura con velcro



☑ Ø 105xh81,5 cm ca ☑ 10/30  
☑ fusto: Ø 1 cm ca ☑ SE SU (BI) TR





altezza:  
cm 86



diametro:  
cm 105



apertura:  
automatica

### PL127 RAINBOW

ombrello automatico in nylon taffetà 170T  
struttura in fibra di vetro  
chiusura con velcro  
fusto e puntale in metallo nero  
manico in plastica



☒ Ø 105xh86 cm ca ☒ 10/30  
☒ fusto: Ø 1 cm ca ☒ SE SU (BI) TR



## MINI OMBRELLO PIEGHEVOLE CON STRUTTURA ANTIVENTO



altezza:  
cm 28



diametro:  
cm 97



apertura:  
automatica



struttura  
antivento

  
cavallari

NEW!

manico con bottone



struttura antivento



custodia in tinta



### CA650 STREET

mini ombrello automatico in poliestere pongee, struttura e fusto in metallo, chiusura in velcro antivento, manico in plastica, custodia inclusa



☐ Ø 97xh28 cm ca ☐ chiuso: h28 cm ca  
☐ 10/30 ☐ fusto: Ø1 cm ca ☐ SE TR



BL



GR



NE

### PL129 BROLLY

mini ombrello automatico in nylon taffetà 170T  
 apertura e chiusura automatica  
 3 sezioni antivento, fusto in metallo nero  
 struttura in fibra di vetro, laccio da polso  
 rib in metallo temperato e rinforzato  
 manico in plastica, chiusura con velcro



☑️ Ø 97xh55 cm ca ☑️ chiuso: h21 cm ca  
 ☑️ 10/30 ☑️ fusto: Ø1 cm ca ☑️ SE TR



altezza:  
cm 55



diametro:  
cm 97



apertura:  
automatica



BL



BO



NE



apertura-  
chiusura  
automatica

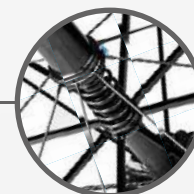

struttura rinforzata  
in fibra di vetro

### PL131 DAMP

mini ombrello automatico in poliestere pongee  
 fusto in metallo nero, 3 sezioni antivento  
 rib in metallo temperato e rinforzato  
 manico in plastica colorata in tinta  
 chiusura con velcro



☑️ Ø 94xh53 cm ca ☑️ chiuso: h32 cm ca  
 ☑️ 10/30 ☑️ fusto: Ø1 cm ca ☑️ SE SU (BI) TR



altezza:  
cm 53



diametro:  
cm 94



apertura:  
automatica



BL



BI



NE



RO



fodera  
in tinta

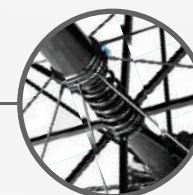

struttura rinforzata  
in fibra di vetro



**PL134 COLORAIN**

mini ombrello in nylon taffetà 170T, apertura manuale  
fusto in metallo, 3 sezioni antivento  
laccio da polso colorato, chiusura con velcro  
manico in plastica colorata in tinta



☑ Ø 88xh56 cm ca ☑ chiuso: h24 cm ca  
☑ 10/30 ☑ fusto: Ø 1 cm ca ☑ SE SU (BI) TR



altezza:  
cm 56



diametro:  
cm 88



apertura:  
automatica



fodera  
in tinta

manico  
in tinta

**PL135 POCKET**

mini ombrello automatico in nylon taffetà 170T  
rib in metallo temperato e rinforzato  
manico in plastica silver antigraffio  
fusto in metallo, chiusura con velcro



☑ Ø 92xh50 cm ca ☑ chiuso: h39,5 cm ca  
☑ 10/50 ☑ fusto: Ø 1 cm ca ☑ SE SU (BI) TR



altezza:  
cm 50



diametro:  
cm 92



apertura:  
automatica



manico in  
plastica silver

fodera  
in tinta

### PL136 HELSINKI

mini ombrello in nylon taffetà 170T  
 apertura manuale, fusto in metallo  
 3 sezioni antivento, interno a contrasto  
 laccio da polso, chiusura con velcro  
 manico in plastica silver antigraffio



altezza:  
cm 56



diametro:  
cm 88



☑ Ø 88x56 cm ca ☑ chiuso: h24 cm ca  
 ☑ 10/30 ☑ fusto: Ø1 cm ca ☑ SE TR



### GIACCA E PONCHO IMPERMEABILI

### PL260 PONCHO

poncho gofrato in pvc, 300 g  
 impermeabile con cappuccio  
 aperture laterali  
 bottoni a pressione, pouch



☑ taglie: XL - XXL  
 ☑ pouch: 22x21 cm ca  
 ☑ 10/50 ☑ SE





GI

**PL270 SAILING**

impermeabile gofrato in pvc con cappuccio, 2 tasche laterali  
chiusura con bottoni a pressione, corredato di pouch 22x20 cm ca  
spessore pvc: mm 0,12 ca



📏 taglie: XL - XXL

📦 10/50 🌐 SE



RO



RY

**PL280 LLUVIA**

giacca anti pioggia in pvc gofrato  
bottoni a pressione  
fodera interna retinata  
chiusura con zip, 2 tasche laterali  
cappuccio cm 38 ca  
spessore pvc: mm 0,30 ca



📏 taglie: M - L - XL - XXL

📦 5/25 🌐 SE

GIACCA  
ANTIPIOGGIA  
CON FODERA  
RETINATA



GI



BL

# 13.

ABBIGLIAMENTO  
E TESSILE

**NAKOTA**  
**START FROM**  
**ZERO**



# NAKOTA

## START FROM ZERO

Poiché la maglietta è il capo d'abbigliamento più indossato al mondo, confort e resistenza devono essere le caratteristiche indispensabili.

# ZERO



### STRESS:

Il mix tra il design moderno delle linee, la morbidezza del tessuto in cotone e le finiture perfettamente cucite regala alla t-shirt una vestibilità confortevole.

### PILLING:

La tecnica del bruciapelo evita la formazione di fibre e pilling che si presentano con l'uso e la manutenzione del capo.

### SHRINKING:

Una particolare lavorazione ne impedisce il restringimento dopo numerosi lavaggi.

La qualità del materiale consente una resa di stampa impeccabile. È possibile personalizzare con qualsiasi logo anche l'interno del collo della t-shirt per soddisfare le esigenze più eterogenee. Nessuna sbavatura o imperfezione.



T-shirt adulto 100% cotone semi pettinato  
cuciture laterali, nastro di rinforzo collo  
tessuto avvolgente e soffice

**PM000** Busta su richiesta



**NK150 NAKOTA 150 COLOR**

T-shirt colorata 100% cotone semi pettinato



XS S M L XL XXL XXXL  
150 g/m<sup>2</sup> 10/100



AR



BL



GI

**NK151 NAKOTA 150 WHITE**

T-shirt bianca 100% cotone semi pettinato



XS S M L XL XXL XXXL  
150 g/m<sup>2</sup> 10/100



NE



RO



VE



**NK100 ZERO**

T-shirt adulto 100% cotone pettinato cuciture laterali, nastro di rinforzo collo trattamento antipilling, colori reattivi tessuto avvolgente e soffice



☑ XS S M L XL XXL XXXL

📦 150 g/m2 📦 10/100

**PM000** Busta su richiesta



**ANTI PILLING**

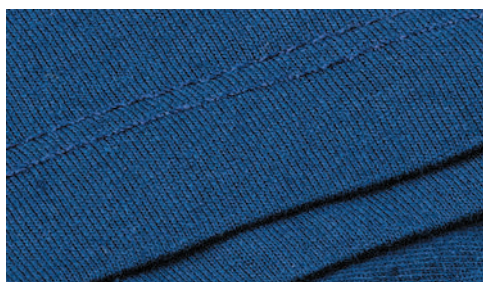

AR



GR



NE



RO



RY



VE



**NK101 WHITE ZERO**

T-shirt adulto cotone pettinato  
cuciture laterali, nastro di rinforzo collo  
trattamento antipilling, colori reattivi  
tessuto avvolgente e soffice



XS S M L XL XXL XXXL

150 g/m<sup>2</sup> 10/100

**NK102 WHITE JUNIOR ZERO**

T-shirt bambino cotone pettinato  
cuciture laterali, nastro di rinforzo collo  
trattamento antipilling, colori reattivi  
tessuto avvolgente e soffice



XXS XXXS XXXXS

150 g/m<sup>2</sup> 10/100

**PM000** Busta su richiesta



**PM000** Busta su richiesta







**NK103 JUNIOR ZERO**

T-shirt bambino 100% cotone pettinato cuciture laterali, nastro di rinforzo collo trattamento antipilling, colori reattivi tessuto avvolgente e soffice



- XXS XXXS XXXXS
- 150 g/m2  10/100

**PM000** Busta su richiesta



BL



GI



RY



VE



### MIAMI

Polo mezza manica 100% cotone piquet pettinato ribattitura doppio ago su collo, maniche e orlo nastro di rinforzo interno, spacchi laterali 3 bottoni + 1 bottone di ricambio incluso



### NK200

Polo mezza manica colori reattivi



S M L XL XXL  
180 g/m2 5/20



AR



BL



GI

### NK201BI

Polo mezza manica bianca



S M L XL XXL  
180 g/m2 5/20



ML



NE



RO



VE



BI



collo con profili tricolore



ribattitura doppio ago su collo, maniche e orlo



maniche con profili tricolore

**NK205 ITALIA**

polo mezza manica con profili tricolore  
 100% cotone piquet pettinato  
 collo e giromanica a costina rinforzata  
 ribattitura doppio ago su:  
 collo, maniche e orlo  
 2 bottoni di cui 1 a scomparsa  
 colori reattivi, spacchi laterali  
 nastro di rinforzo interno



S M L XL XXL

180 g/m<sup>2</sup> 5/20

BL



RY

**PM000** Busta su richiesta



### LOS ANGELES

polo mezza manica 65% poliestere 35% cotone piquet, ribattitura doppio ago su collo, maniche e orlo, spacchi laterali, nastro di rinforzo interno, 3 bottoni, colletto e giromanica a costina rinforzata, bottone di ricambio incluso



#### NK210

Polo colori reattivi



☑ S M L XL XXL  
 ☑ 180 g/m2 ☑ 5/20



NK211BI



NK210BL



NK210NE

#### NK211BI

Polo bianca



☑ S M L XL XXL  
 ☑ 185 g/m2 ☑ 5/20



collo elasticizzato



ribattitura doppio ago su collo, maniche e orlo



polsini elasticizzati

### NK300 CLASSIC

felpa girocollo 60% cotone 40% poliestere  
 ribattitura doppio ago su collo, maniche e orlo  
 collo, polsini e girovita elasticizzati, colori reattivi



☑ S M L XL XXL  
 ☑ 280 g/m2 ☑ 1/30



BI



BL



ML



NE



RO



VE



cappuccio con cordoncini



ribattitura doppio ago su collo, maniche e orlo



polsini e girovita elasticizzati

### NK305 HOODIE

felpa con cappuccio e cordoncini  
 60% cotone 40% poliestere  
 colori reattivi, tasca a marsupio  
 polsini e girovita elasticizzati  
 ribattitura doppio ago su collo, maniche e orlo



☑ S M L XL XXL  
 📏 280 g/m2 📦 1/30



BI



BL



ML



NE



RY



VE



collo a lupetto con zip e cursore



ribattitura doppio ago su collo, maniche e orlo



polsini elasticizzati

## NK310 COMFORT

felpa con collo a lupetto 60% cotone 40% poliestere, collo, polsini e girovita elasticizzati  
zip corta con cursore removibile, ribattitura doppio ago su collo, maniche e orlo  
nastro di rinforzo interno da spalla a spalla, colori reattivi



☑ S M L XL XXL

📏 280 g/m2 📦 1/20



AR



BL



NE



ML



colletto antivento con zip e cursore removibile



ribattitura doppio ago su collo, maniche e orlo



polsini elasticizzati

### NK315 STADIUM

felpa con cappuccio 60% cotone 40% poliestere, zip lunga con cursore removibile  
 polsini e girovita elasticizzati, colletto antivento, due tasche a marsupio, colori reattivi  
 ribattitura doppio ago su collo, maniche e orlo, nastro di rinforzo interno da spalla a spalla



☑ S M L XL XXL  
 ☑ 280 g/m2 ☑ 1/20



BL



ML



NE



RY





RY



collo a lupetto con tricolore



ribattitura doppio ago su collo, maniche e orlo



polsini elasticizzati con tricolore

**NK320 TRICOLORE**

felpa con collo a lupetto  
 60% poliestere 40% cotone  
 ribattitura doppio ago su:  
 collo, maniche e orlo  
 nastro di rinforzo interno:  
 da spalla a spalla  
 collo e polsini con tricolore  
 colori reattivi  
 zip lunga nascosta  
 2 tasche con zip  
 doppio cursore removibile  
 polsini e girovita elasticizzati

 S M L XL XXL

 280 g/m2  1/20

BI



BL





cappuccio e collo antivento

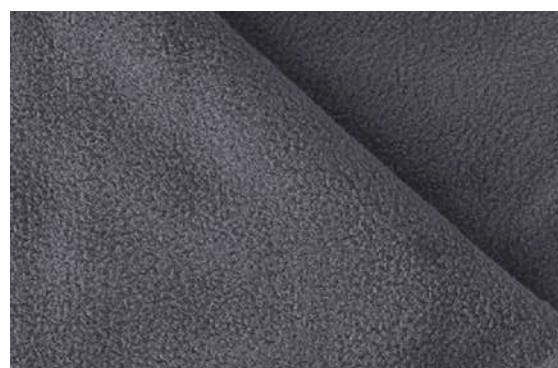

fodera interna in micropile

### NK325 CANADA

giubbino con cappuccio, colori reattivi  
 esterno 100% cotone  
 fodera interna micropile 100% poliestere  
 ribattitura doppio ago su collo, polsini e orlo  
 collo antivento  
 2 tasche a marsupio  
 zip lunga  
 nastro di rinforzo interno



M L XL XXL  
 280 g/m2 1/20



BL



NE

**PM090 NEW JERSEY**

berretto 5 pannelli 100% cotone jersey  
 fascia tergisudore,occhielli ricamati,  
 frontalino rinforzato, visiera rigida  
 sagomata, colori reattivi



📄 taglia unica  
 📦 50/200

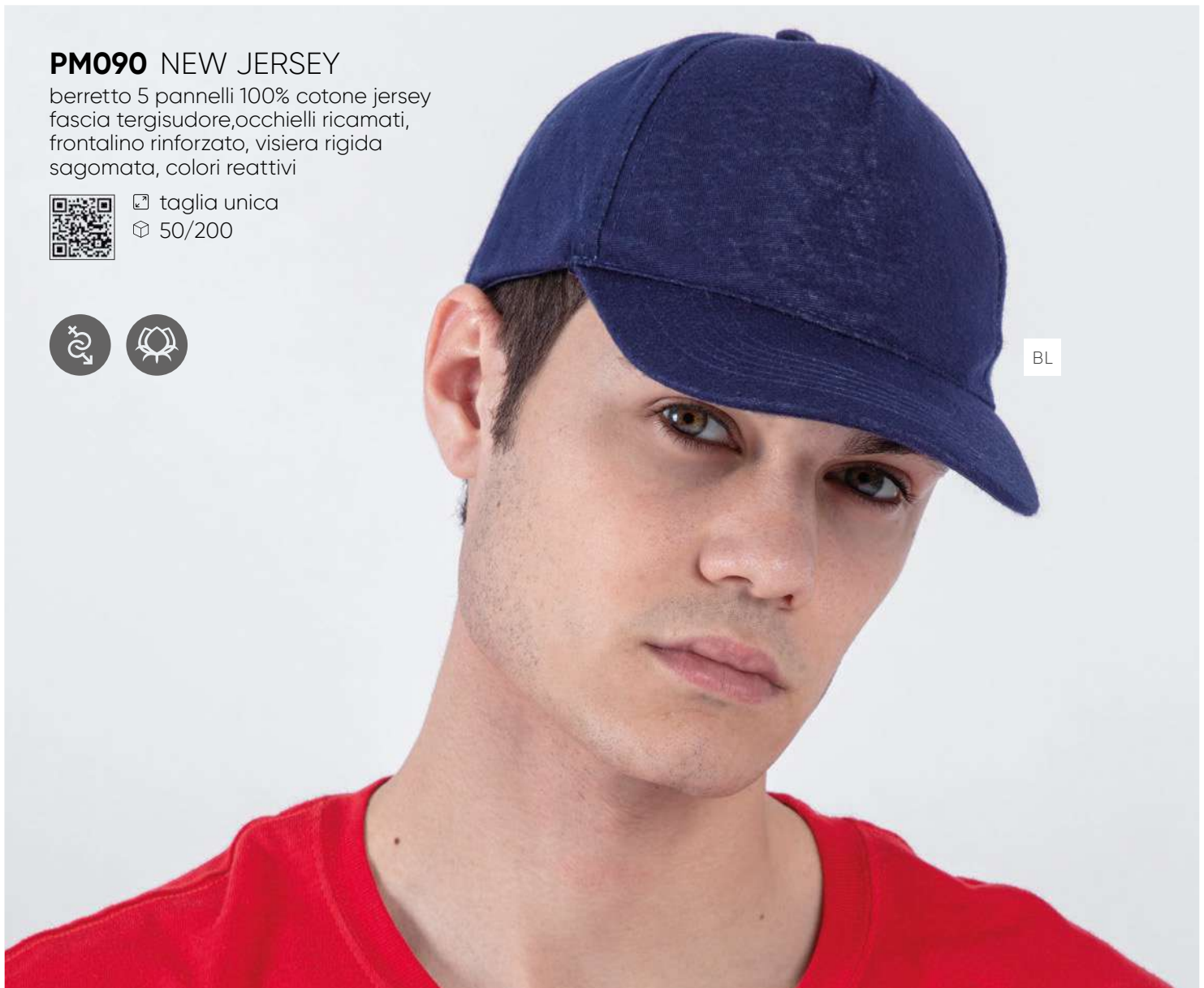

BERRETTO UNISEX  
 5 PANNELLI  
**100% COTONE  
 JERSEY**



chiusura con velcro



cotone jersey

**PM092** KOPY

berretto 5 pannelli in RPET, fascia tergisudore in colore abbinato, occhielli ricamati, frontalino rinforzato, visiera rigida sagomata chiusura in velcro regolabile in colore abbinato



☑️ taglia unica  
📦 50/200



BL



chiusura in velcro



tessuto RPET



**ZERO SPRECHI**  
BERRETTO RPET  
ECO-FRIENDLY



BI



NE



RO



VE

**PM093 STRIPE**

berretto 5 pannelli, 100% cotone twill 108/58  
 fascia tergisudore, occhielli ricamati  
 colori reattivi, frontalino rinforzato  
 visiera doppio pannello rigida sagomata  
 chiusura in velcro



📄 taglia unica

📦 50/200



RY



chiusura in velcro



BERRETTO UNISEX  
 5 PANNELLI  
**100% COTONE**  
**TWILL 108/58**



AR



AZ



BL



GI



IT



NE



RO



VE

### PM102 GOLF ITALY

berretto 5 pannelli 100% cotone twill 108/58  
 fascia tergisudore in colore abbinato  
 bandiera Italia ricamata, chiusura in velcro  
 occhielli ricamati, frontalino rinforzato  
 visiera rigida sagomata, colori reattivi



taglia unica  
 50/200

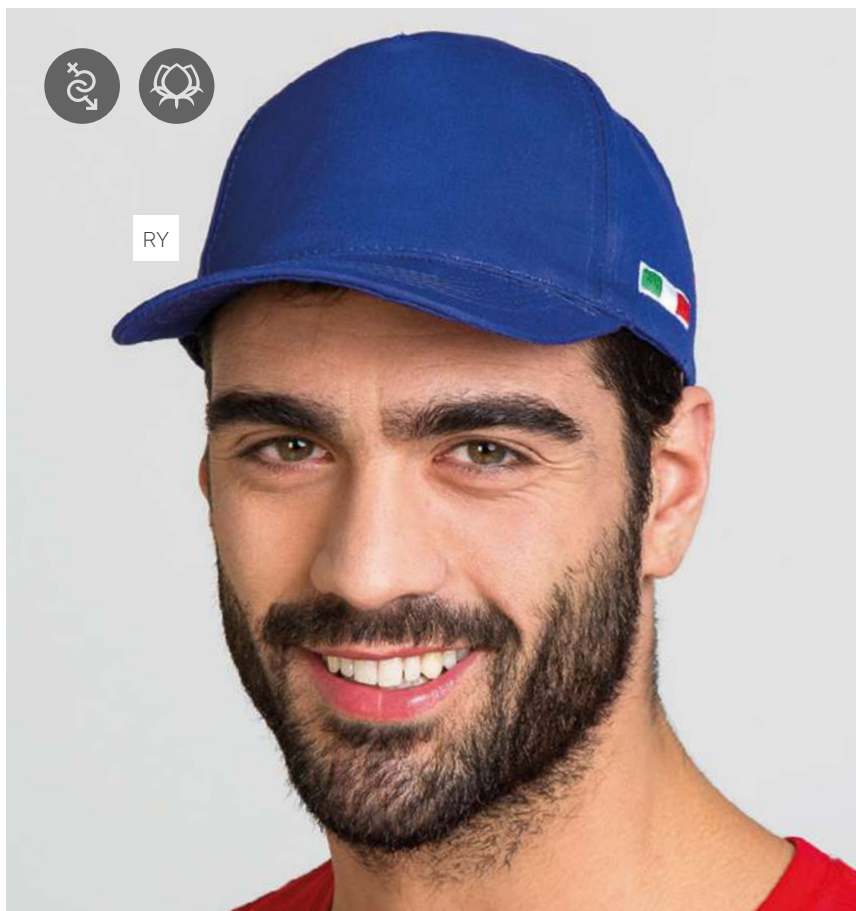

### PM103 WINNER

berretto 5 pannelli 100% cotone twill 108/58  
 colori reattivi, occhielli ricamati  
 fascia tergisudore in colore abbinato  
 frontalino rinforzato, chiusura in velcro  
 visiera rigida sagomata  
 tricolore stampato su visiera



taglia unica  
 50/200





**PM101** BABY

berretto 5 pannelli bambino 100% cotone twill 108/58, colori reattivi  
 fascia tergisudore in colore abbinato, occhielli ricamati, frontalino rinforzato  
 visiera rigida sagomata, chiusura in velcro



- taglia unica
- 50/200



AR



AZ



BI



BL



chiusura in velcro



GI



RO



RY

### PM105 BASIC GOLF

berretto 5 pannelli 100% cotone twill 108/58  
 fascia tergisudore in colore abbinato  
 occhielli ricamati, frontalino rinforzato  
 visiera rigida sagomata, colori reattivi  
 chiusura in velcro



📄 taglia unica

📦 50/200



chiusura in velcro

AR

AZ



### BERRETTO 5 PANNELLI UNISEX 100% COTONE TWILL 108/58



BI



BL



BO



GI



GR



NE



RO



RS



RY



VE



VL



VM



VS



WB



**PM108 BASEBALL**

berretto 5 pannelli 100% cotone twill 108/58  
 fascia tergisudore in colore abbinato  
 occhielli ricamati, frontalino rinforzato  
 visiera rigida sagomata con piping a contrasto  
 colori reattivi, chiusura in velcro



📄 taglia unica

📦 50/200



chiusura in velcro

RO

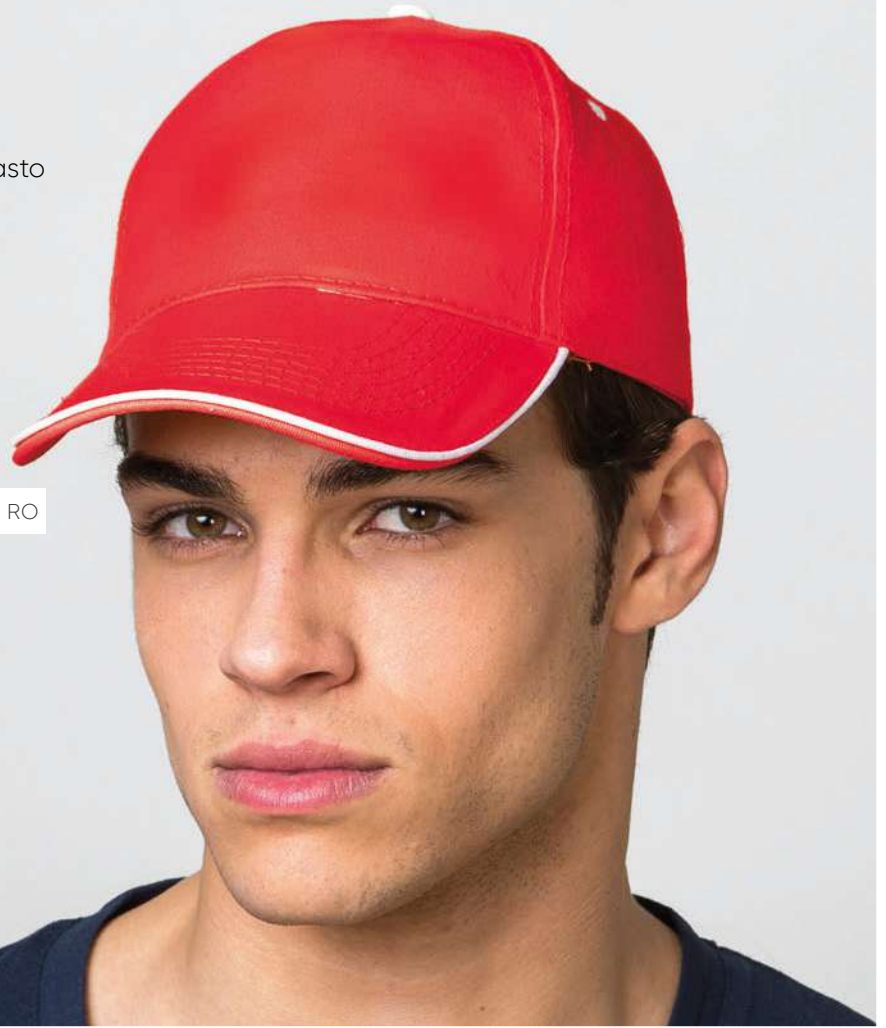

**BERRETTO 5 PANNELLI UNISEX**  
**100% COTONE TWILL 108/58**



AR



BI



BL



GI



NE



RY



VS

### PM150 3 PANNELLI

berretto 3 pannelli 100% cotone twill 108/58  
visiera rigida, chiusura con elastico



- ☑️ taglia unica
- 📦 50/300

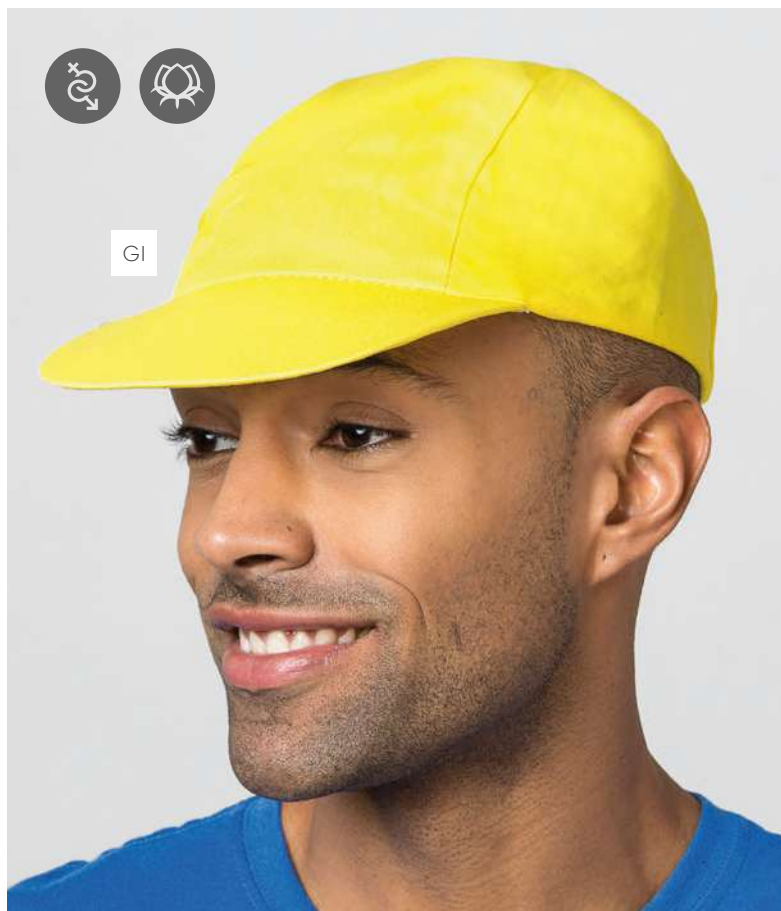

### PM155 SKYLINE

cappello 3 pannelli 100% cotone twill 108/58  
fascia tergisudore, colori reattivi



- ☑️ taglie preassortite 1L 2XL 1XXL
- 📦 100/300



**PM175 COOL**

cappello 100% poliestere, fascia tergisudore



taglia unica

50/200

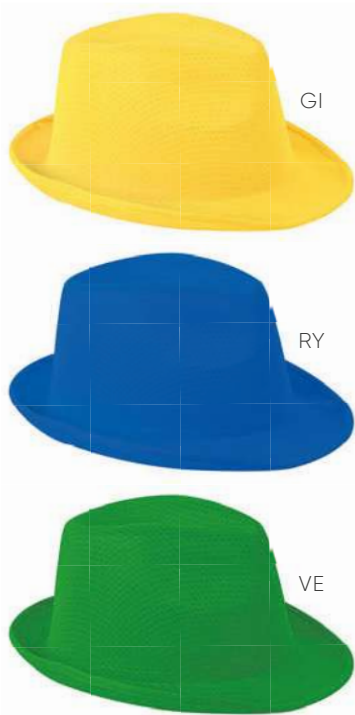
**PM185 TRIUMPH**bandana 100% poliestere taffetà  
fazzoletto da collo, colori reattivi

99x66x50 cm ca

100/1000

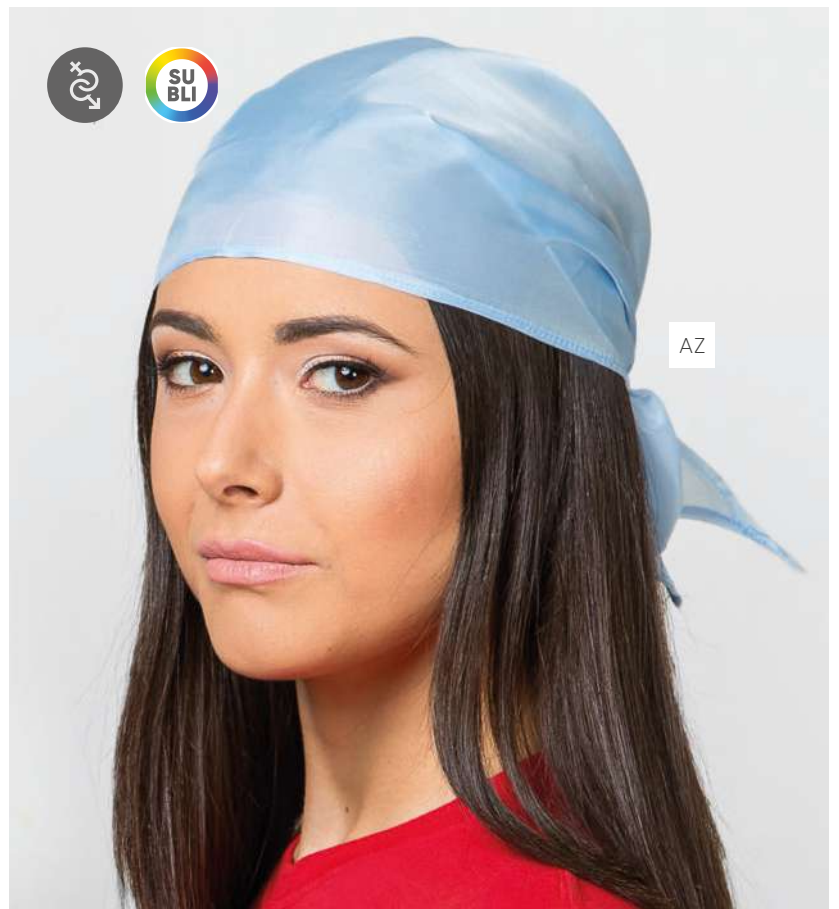

**PM188 HARLEY**

bandana 80% poliestere 20% cotone  
colori reattivi, fazzoletto da collo  
lacci cm 20 per lato



77x53x30 cm ca  
100/400

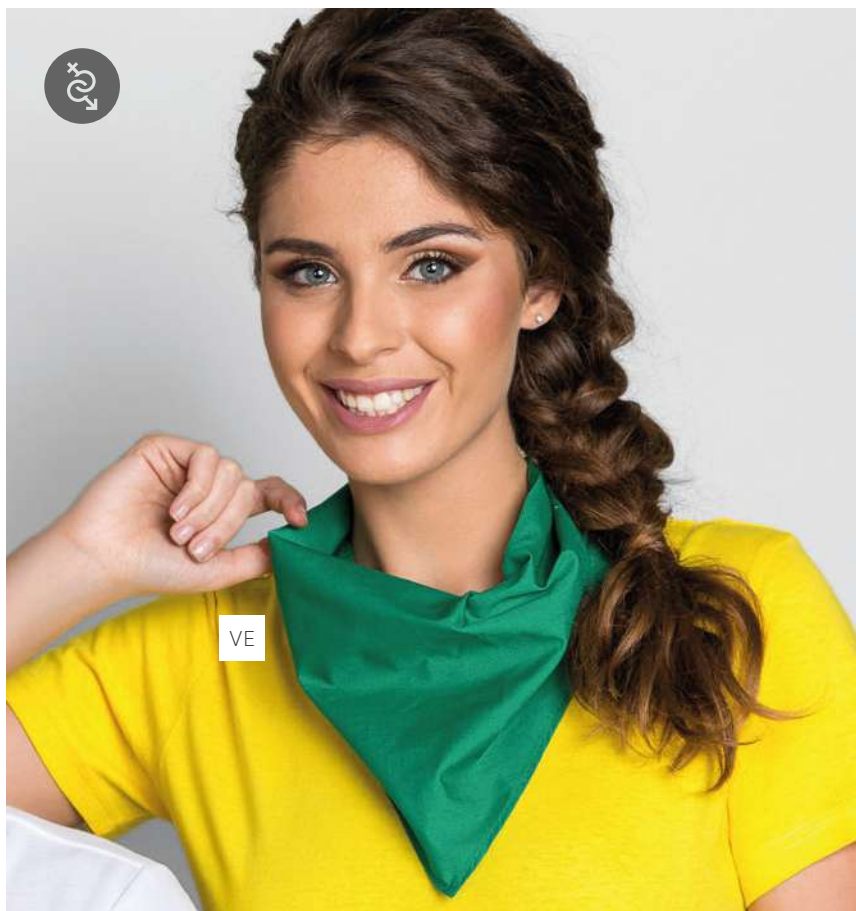

**PM189 ANISA**

fazzoletto/bandana  
65% poliestere 35% cotone





52x52 cm ca  
50/400



**PM190 HOGAN**

bandana colori reattivi  
80% poliestere 20% cotone



-  taglia unica
-  50/400

**PM192 TRAINING**

cappellino doppio strato  
49% poliestere, 35% rayon  
10% acrilico, 6% altre fibre  
etichetta serigrafabile cm 6x3 ca



-  taglia unica
-  55 g  50/200

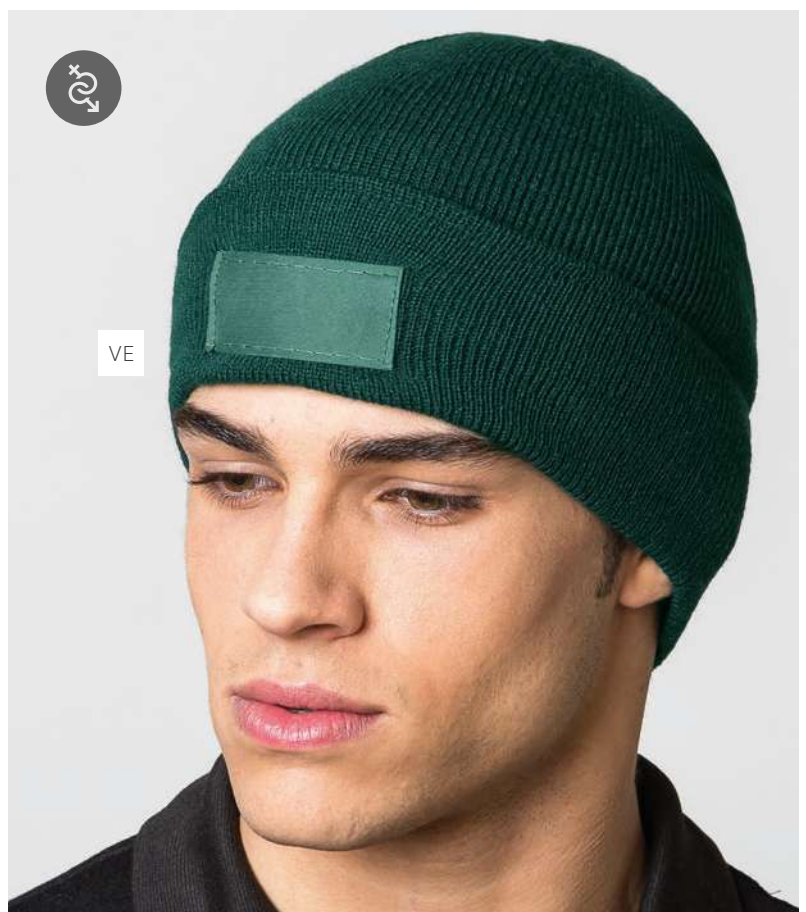

### PM197 SNOWBOARD

cappellino 100% acrilico, doppio strato extrapesante



- taglia unica
- 80 g 50/200



BL



NE



RO



RY



AR

### PM199 FROST

cappellino 100% acrilico  
doppio strato extrapesante  
fodera interna in pile 100% poliestere



- taglia unica
- 80 g 50/100



BL



GR



RY



VM



NE



fodera  
interna  
in pile



RO

**PM194 POLAR**

cappellino 100% poliestere pile antipilling  
etichetta serigrafabile cm 6x3 ca



- ☑ taglia unica
- 📦 280 g 📦 50/200

**PILE  
ANTIPILLING**

BL

GR

NE

RO

VM

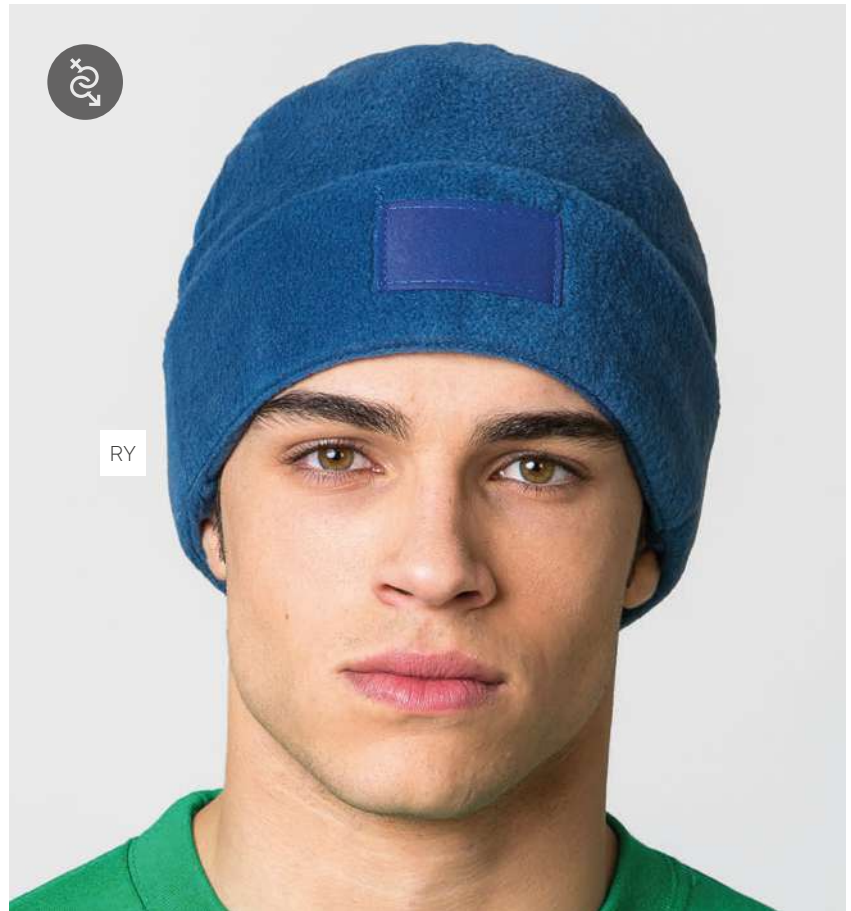

RY

**PM202 NECK**

scaldacollo/copricapo 100% poliestere  
fascia per capelli, pile antipilling  
etichetta serigrafabile cm 6x3 ca



- ☑ 27x24,5 (Ø 56) cm ca
- 📦 280 g 📦 50/200



BL

NE

RY

VM

AF

GF

VF

AF, GF & VF  
**COLORI FLUO**

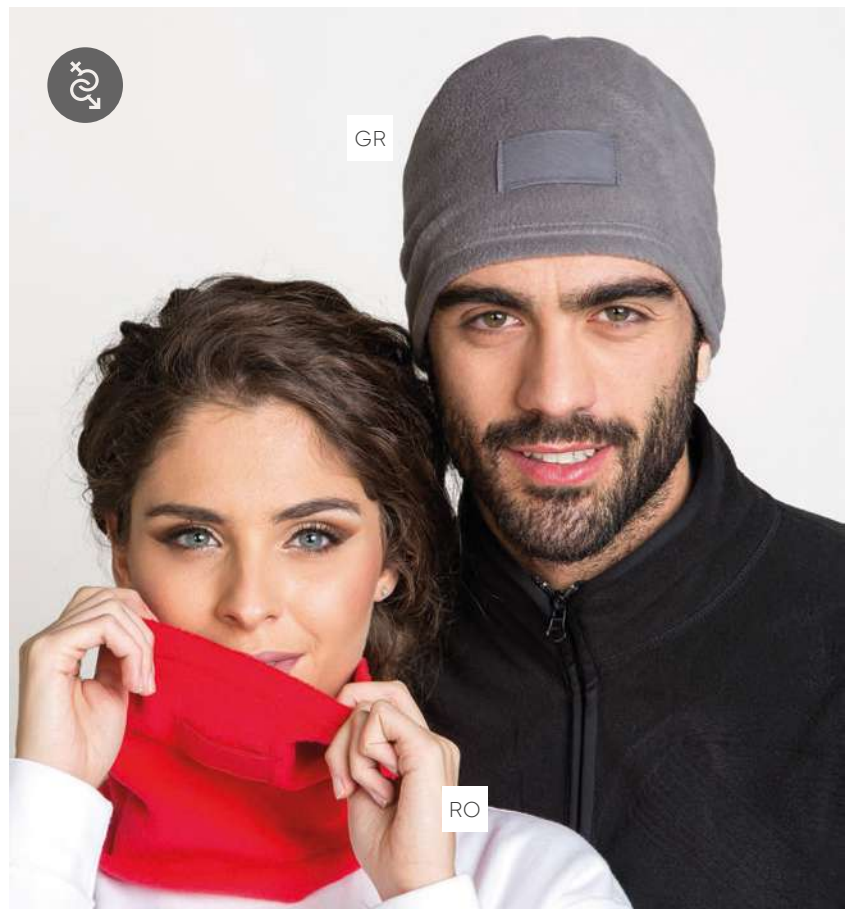

GR

RO

### PM203 DAKAR

bandana multiuso tubolare 100% poliestere  
protezione da vento o polvere



24x48 cm ca  
140 g 10/300



AR



AZ



BI



BL



GI



NE



RO

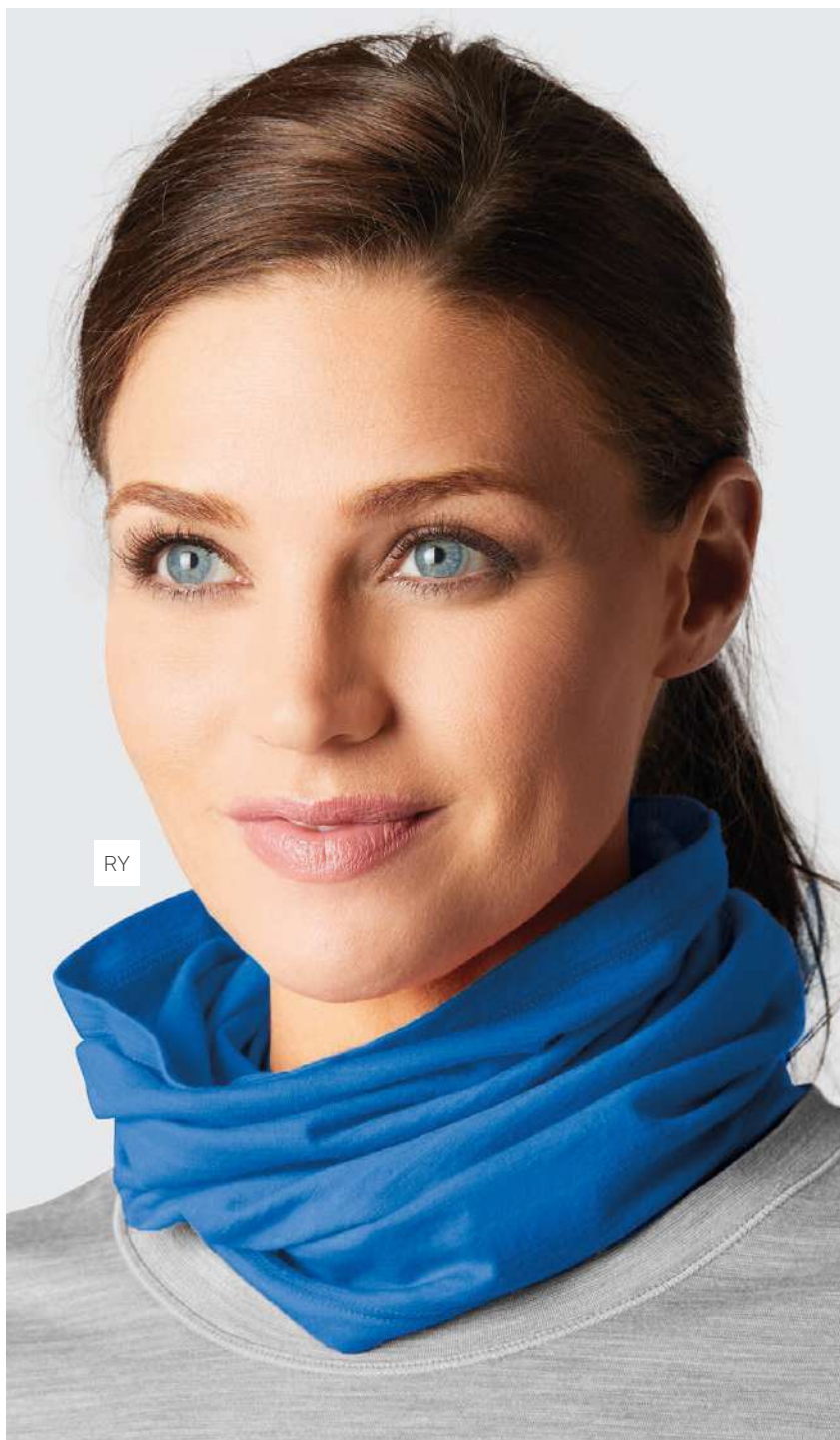

## SCALDACOLLO E BANDANA **MULTIUSO**

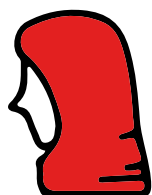

FOULARD

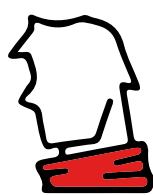

SCALDACOLLO



BANDANA



FASCIA SPORT



COPRICAPO

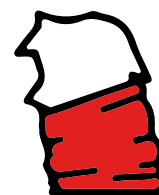

COPRICOLLO  
MEZZO VISIO



**PM210 SPORT ADULT**

T-shirt adulto 100% poliestere  
tessuto mesh extra traspirante  
trattamento cool plus, colorazioni fluo  
asciugatura rapida, girocollo a costina rinforzata  
ribattitura doppio ago su collo maniche e orlo  
nastro di rinforzo interno, maniche raglan  
colori reattivi, adatta alla stampa sublimatica



☑ S M L XL XXL  
📦 120 g 📦 10/60



GI



VE



BI



RY

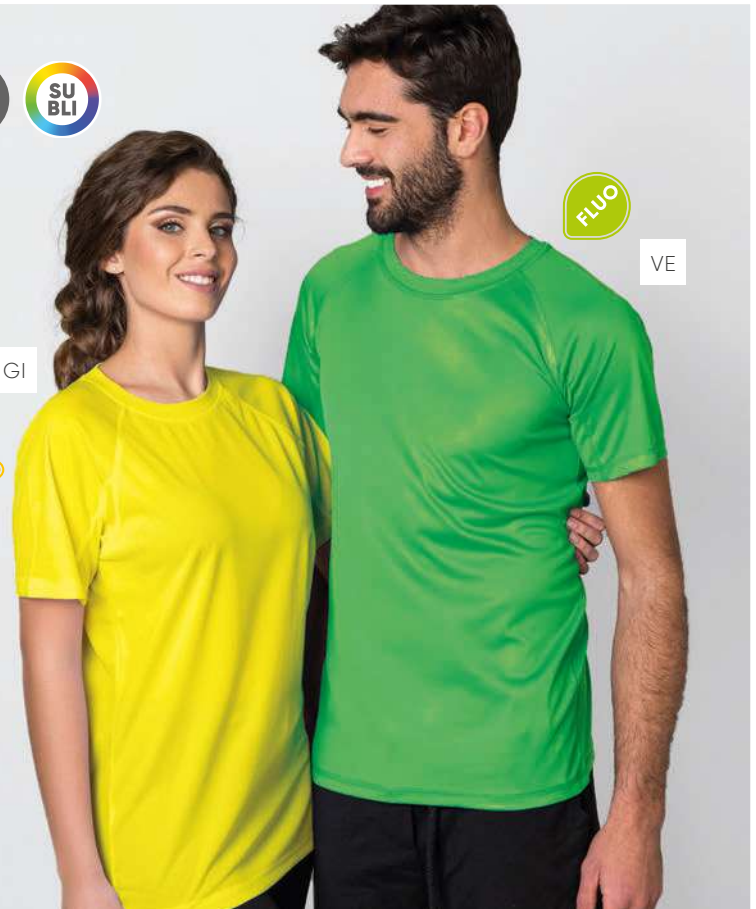

AR

**PM215 TEKNO**

T-shirt adulto 100% poliestere, tessuto mesh extra traspirante  
asciugatura rapida, trattamento cool plus, colori reattivi  
girocollo a costina rinforzata, maniche raglan  
ribattitura doppio ago su collo, maniche e orlo  
nastro di rinforzo interno, adatta alla stampa sublimatica



☑ S M L XL XXL  
📦 120 g 📦 10/60



GI



RO



RY

AR & GI **COLORI FLUO**

### PM220 FRESH

canotta adulto 100% poliestere mesh extra traspirante, colori reattivi  
 trattamento cool plus, asciugatura rapida  
 ribattitura doppio ago su collo, giromanica  
 e orlo adatta alla stampa sublimatica



XS S M L  
 140 g 10/100



AF & GF **COLORI FLUO**



AF

BI

RO

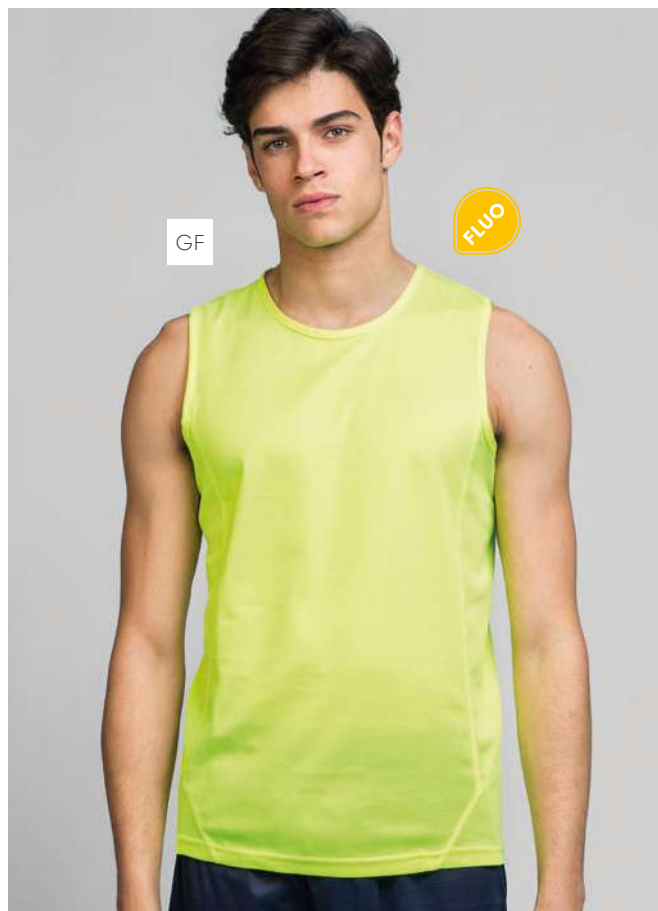

### PM225 BERMUDA

pantaloncini con elastico  
 100% poliestere mesh extra traspirante  
 cordoncino in vita, colori reattivi  
 trattamento cool plus, asciugatura rapida  
 adatto alla stampa sublimatica



S XL XXL  
 5/100



BI

RO



**PM252 BAHAMAS**

costume boxer 100% poliestere, taschino posteriore  
vita elasticizzata con coulisse, tessuto idrorepellente  
rete interna



S M L XL XXL  
1/100



BL



NE



VL



AZ

**PM254 HAWAII**

costume boxer bicolore 100% poliestere  
rete interna, tessuto idrorepellente  
vita elasticizzata con coulisse



S M L XL XXL  
1/100



AZ



RO

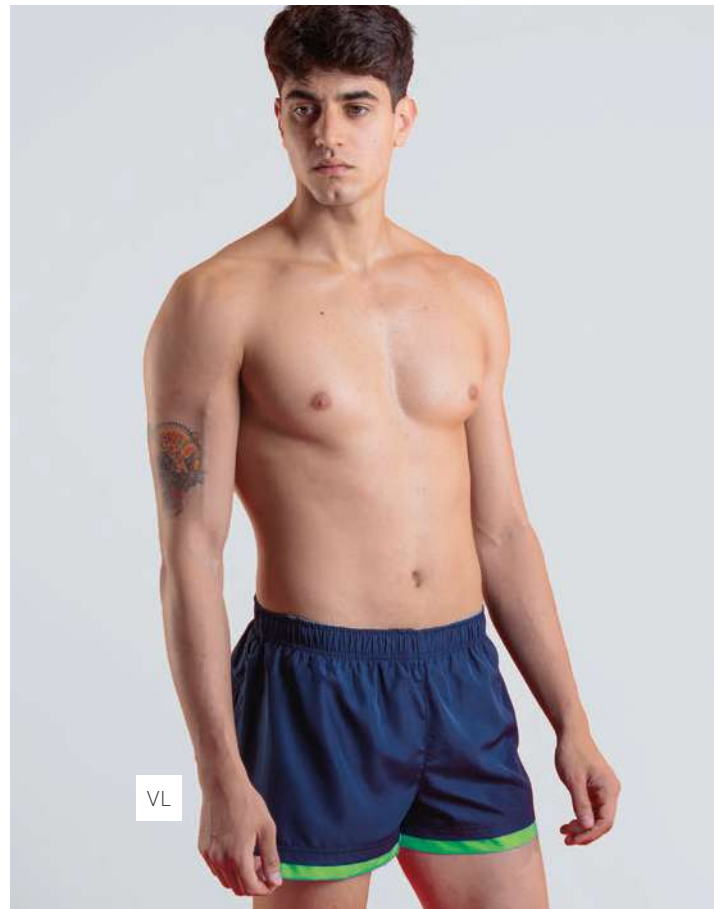

VL

**PM301 LADY 150**

T-shirt donna 100% cotone pettinato  
 ribattitura doppio ago su collo maniche e orlo  
 cuciture laterali  
 nastro di rinforzo interno  
 girocollo a costina rinforzata  
 colori reattivi



S M L 155 g  
 10/100

**PM325 FREEDOM 150 WHITE**

t-shirt adulto cotone pettinato  
 girocollo a costina rinforzata, cuciture laterali  
 ribattitura doppio ago su collo, maniche e orlo  
 nastro di rinforzo interno



XS S M L XL XXL XXXL  
 150 g 5/60



BI



**PM315 FORMENTERA**

T-shirt adulto colori reattivi  
 colore BI: 100% cotone pettinato  
 colore ML: 85% cotone 15% viscosa  
 scollo a V costina rinforzata  
 nastro di rinforzo interno  
 ribattitura doppio ago  
 su collo maniche e orlo



☑ S M L XL  
 📦 150 g 📦 5/60



T-SHIRT ADULTO  
**UNISEX**  
**SCOLLO A V**

**PM320 IBIZA**

T-shirt adulto 100% cotone pettinato  
 cuciture laterali, colori reattivi  
 4 bottoni + 1 di ricambio nastro di rinforzo  
 interno in colore abbinato ribattitura  
 doppio ago su collo maniche e orlo



☑ S M L XL XXL  
 📦 150 g 📦 5/60



NE





**JUNIOR** t-shirt bambino, girocollo a costina rinforzata, ribattitura doppio ago su, collo maniche e orlo nastro di rinforzo interno

**PM328 JUNIOR COLOR**

t-shirt colorata



XXXXS XXXS XXS XS

150 g 10/100

**PM000** Busta su richiesta



**PM333 JUNIOR WHITE**

t-shirt bianca



XXXXS XXXS XXS XS

150 g 10/100

**PM000** Busta su richiesta



PM333BI



PM328AR



PM328GI



PM328RO



PM328RY



PM328VE



## FUERTEVENTURA

Polo mezza manica 100% cotone, nastro di rinforzo interno, spacchi laterali ribattitura doppio ago su collo maniche e orlo, colori reattivi



### PM360 ADULT

polo adulto  
3 bottoni + 1 di ricambio



S M L XL XXL  
200 g 5/20



Bl: PM359



AR: PM360



BO: PM360



GI: PM359-PM360

### PM359 JUNIOR

polo bambino  
2 bottoni + 1 di ricambio



XXXXS XXXS XXS XS  
200 g 5/20



ML: PM360



NE: PM360



RO: PM359-PM360



RY: PM359-PM360

**PM511 NORTH POLE**

pile antipilling 100% poliestere  
 collo a lupetto  
 colori reattivi  
 zip lunga  
 2 tasche laterali  
 zip nascosta in tinta  
 ribattitura doppio ago su:  
 collo, polsini e orlo  
 nastro di rinforzo interno su collo



☑ M L XL XXL  
 📦 270 g 📦 1/20



BL



RY





**PM540 FINLANDIA**

gilet in pile antipilling  
 100% poliestere micropile  
 collo a lupetto, colori reattivi  
 zip lunga con cursore removibile  
 tasche laterali e zip a scomparsa  
 ribattitura doppio ago su:  
 collo, manica e orlo  
 nastro di rinforzo interno  
 da spalla a spalla



☑ M L XL XXL  
 📏 270 g 📦 1/20



BL



NE



RO





tasca sul petto



tasca interna

### PM695 SOUTH POLE

giubbino impermeabile waterproof  
 100% poliestere, interno trapuntato  
 imbottitura extrapesante  
 polsini elastici, zip a scomparsa  
 cursore removibile  
 copricerniera con bottoni a pressione  
 tasca interna, 2 tasche laterali con zip  
 tasca frontale con zip (lato destro)



M L XL XXL

1/10



GR



RO

**PM701 MADRID**

giubbino smanicato impermeabile  
 80% poliestere 20% cotone  
 imbottitura pesante, 2 doppie tasche  
 tasca esterna con zip (lato sinistro)  
 tasca frontale con velcro (lato destro)  
 tasca interna con velcro  
 zip a scomparsa, cursore removibile  
 copricerniera con bottoni a pressione  
 elastico giromanica antivento  
 etichetta interna removibile



M L XL XXL

1/20



elastico giromanica



tasca interna





maniche asportabili



tasca interna

### PM703 AMBURGO

giubbino 100% poliestere pongee impermeabile  
 maniche asportabili, tasca interna  
 zip lunga con cursore removibile  
 polsini elastici regolabili con velcro  
 tasche con velcro e occhiello catarifrangente



M L XL XXL

1/10



BL

**PM704 BAYERN**

giubbino 100% poliestere pongee  
impermeabile  
cappuccio estraibile  
maniche asportabili  
profili rifrangenti  
1 tasca con zip, tasca sul petto  
portabadge a scomparsa  
tasca interna, 2 doppie tasche  
patta e chiusura con velcro  
polsino elastico con velcro



☑ M L XL XXL

📦 1/10



maniche asportabili



cappuccio estraibile



tasca interna



BL



RO



elastico giromanica



taschino interno

### PM706 BURGOS

giubbino smanicato 100% poliestere pongee imbottitura pesante e fodera in poliestere zip a scomparsa con cursore removibile, profili rifrangenti, copricerniera con bottoni a pressione, elastico giromanica antivento, 2 tasche con zip, tasca frontale sul petto con portabadge a scomparsa, 2 doppie tasche con patta e chiusura con velcro, tasca interna portacellulare, tasca interna portafogli



M L XL XXL

1/20



BL



NE

**PM714 OVIEDO**

giubbino smanicato  
 100% poliestere pongee  
 impermeabile, tasca interna  
 zip lunga con cursore removibile  
 tasche con velcro  
 occhielli catarinfrangenti



M L XL XXL

1/20



BL



tasca interna



### PM716 LISBONA

giubbino smanicato 100% poliestere  
 zip lunga con cursore removibile  
 tasca interna, due tasche laterali  
 tasca frontale verticale  
 portabadge a scomparsa



M L XL XXL

1/20



tasca interna



tasca verticale portabadge





**PM780 LONDON**

impermeabile antivento  
 100% poliestere  
 polsini elastici  
 interno a contrasto  
 cappuccio a scomparsa  
 laccio stringivita  
 tasche laterali  
 ripiegabile in pouch



M L XL XXL  
 1/36



BL



NE



ripiegabile  
 in pouch



RY

**PM809 WESTWARD**

gilet multitasche

80% poliestere 20% cotone

chiusura con zip

doppia tasca sul retro

profili rifrangenti

gancio portachiavi

tasca frontale con portabadge

fodera interna in tessuto traspirante



M L XL XXL

1/50



gancio portachiavi



fodera interna traspirante

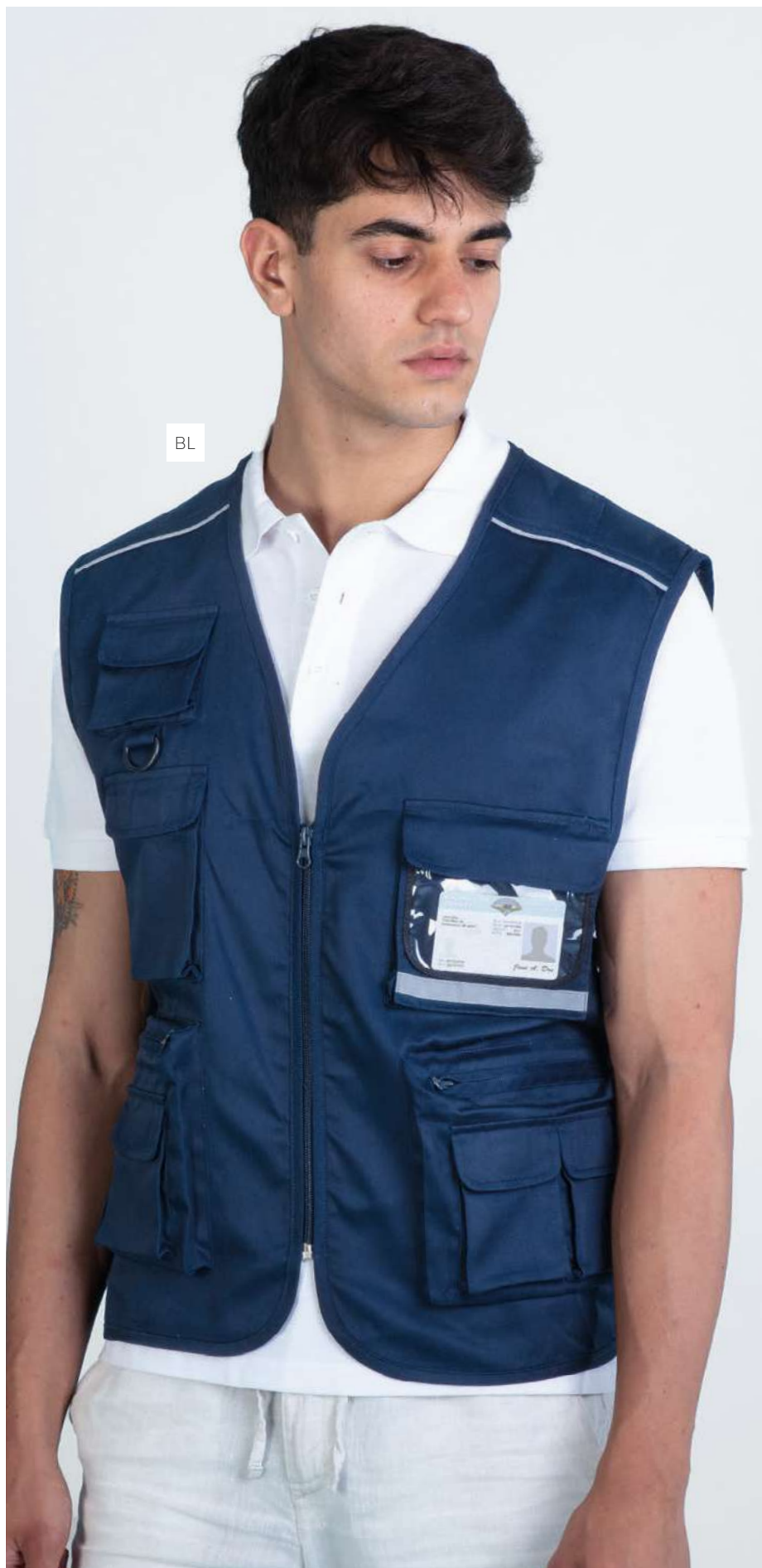



gancio portachiavi



fodera interna traspirante

**PM811 MULTIPLO**

gilet multitasche  
80% poliestere 20% cotone  
chiusura con zip, gancio portachiavi  
doppia tasca sul retro  
fodera interna in tessuto traspirante



M L XL XXL  
1/50



BG



BL



**PM600** MULTIUSO

camice multiuso no-stiro 65% poliestere 35% cotone  
 materiale traspirante antiristringimento  
 2 tasche sui fianchi 1 tasca sul petto multiuso  
 chiusura con bottoni, rifinita con cintura a vita



S M L XL XXL XXXL

200 g 10/100



**PM815** GOAL

casacca in tnt, chiusura laterale con velcro



53x65 cm ca

10/100

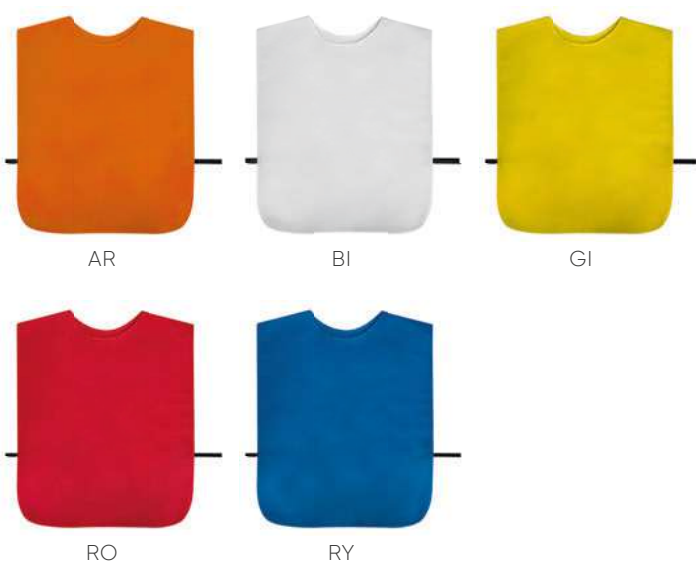

cintura posteriore a vita



PM819AR

PM819RY

**PM819 DERBY**

casacca adulto 100% poliestere, 1 elastico per lato



64x54 cm ca  
10/100



BI



BL



GI



VE



PM824AR

**PM824 SAFETY JACKET**

gilet di sicurezza 100% poliestere, profili rifrangenti



65x65 cm ca  
10/100



GI

14.

TELI E  
ASCIUGAMANI





## EFFETTO GHIACCIO A CONTATTO CON L'ACQUA

Tessuto super assorbente  
100% poliestere  
traspirante e ultraleggero



1. BAGNA IL TELO



2. STRIZZA IL TELO



3. INDOSSALO



### PM905 ICE TOWEL



30x100 cm ca  
10/200 SE

### PM906 LIGHT TOWEL



28x75 cm ca  
10/200 SE SU (BI)

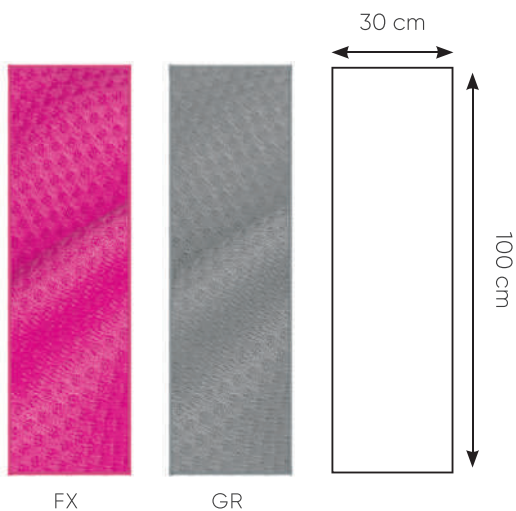
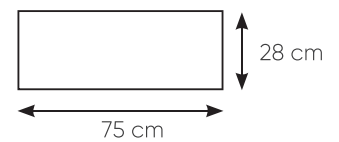



**TELI MARE  
E PALESTRA  
IN MICROFIBRA**



**PM900 FITNESS**



50x100 cm ca  
1/100 SE SU(BI)

**PM911 SWIMMY**



75x150 cm ca  
1/30 SE SU(BI)

**PM915 BIG SWIMMY**



100x150 cm ca  
3/24 SE SU(BI)



AR

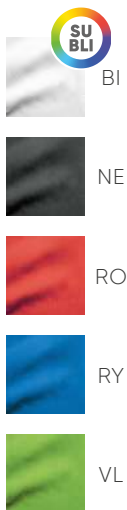

RO

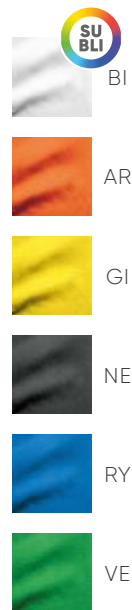

RY

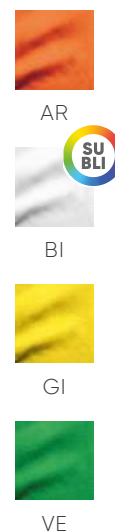



## TELO PALESTRA COTONE AIR JET

I tessuti di questo materiale sono particolarmente resistenti all'usura e al pilling, la brillantezza e la delicatezza della superficie rimangono inalterate anche dopo numerosi lavaggi.



### PM921 ENERGY

telo palestra 100% cotone air jet, banda "easy print" personalizzabile 40x6 cm ca



📏 50x90 cm ca 📦 6/60  
⚖️ 380 gr 🏠 SE

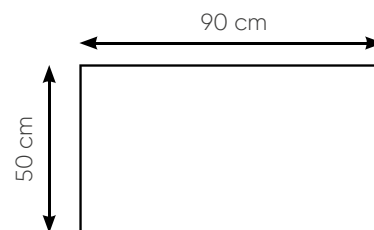

AZ



BL



FX



GR

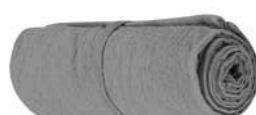

NE



**TELI CON BANDA  
EASY PRINT**  
PER UNA FACILE  
PERSONALIZZAZIONE



100% COTONE  
SPUGNA BORDATA



**PM925 GYM**

banda "easy print" personalizzabile 40x10 cm ca



50x100 cm ca 6/60  
400 gr SE



BL



NE



RO

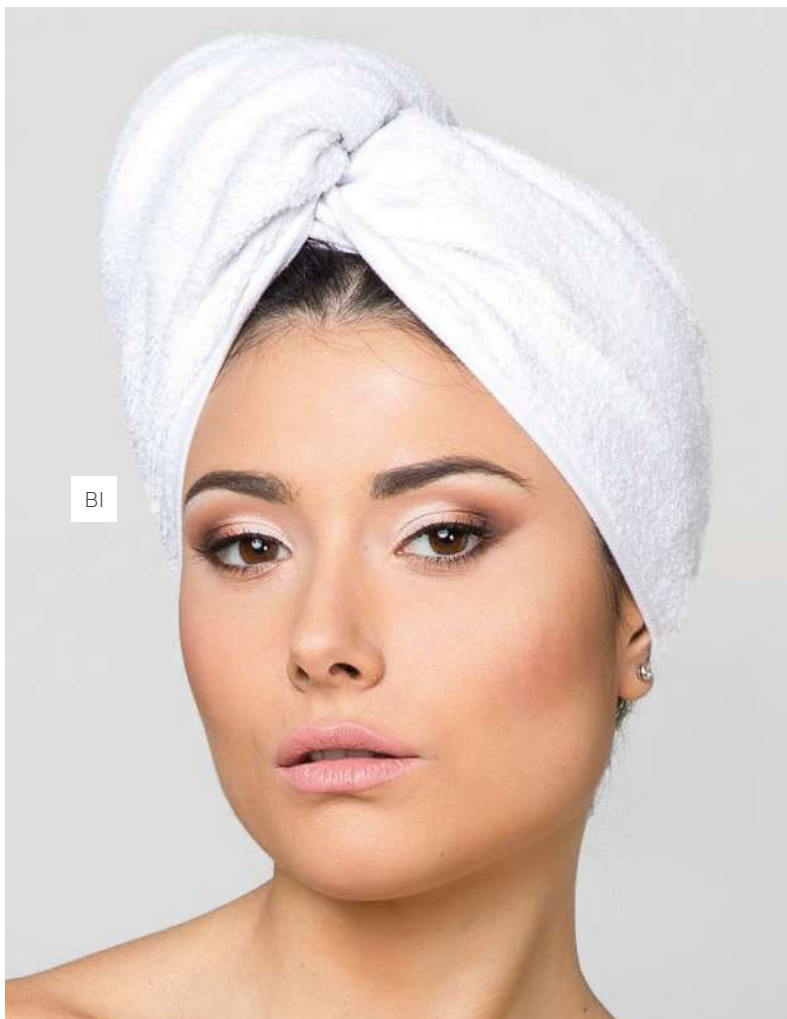

BI

**PM930 SUNNY**

banda "easy print" personalizzato 50x7 cm ca



70x140 cm ca 3/36

400 gr SE

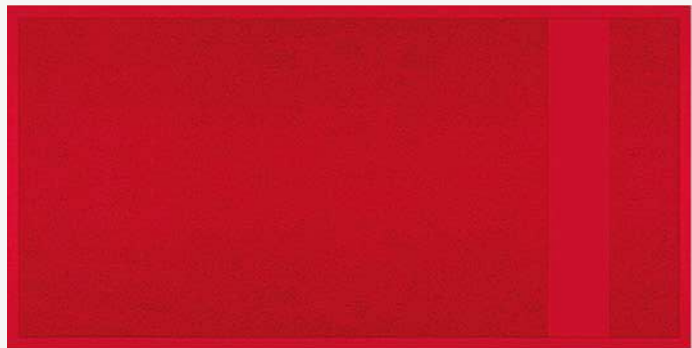

RO



AR



AZ



BI



BL



GI

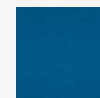

RY



VL

**PM938 MYKONOS**

banda "easy print" personalizzato 70x8 cm ca



100x180 cm ca 3/24

400 gr SE

RY

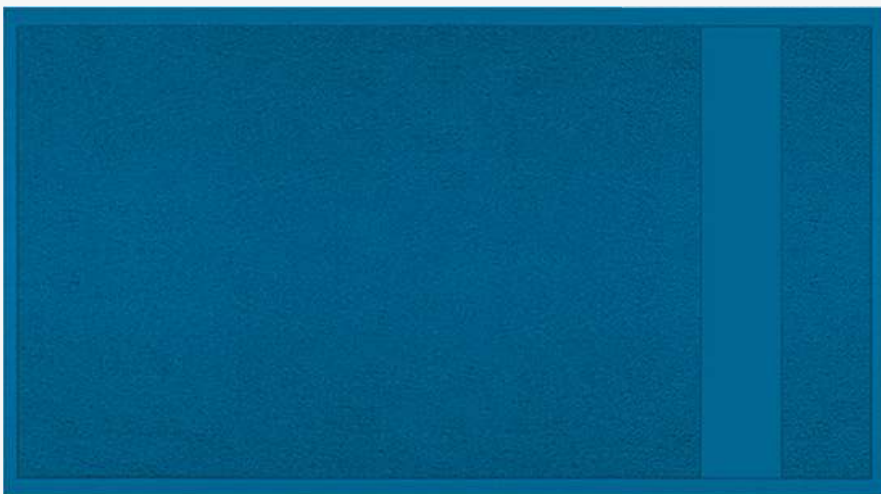

AR



AZ



BI



BL



GI



RO



VL



# ASCIUGAMANI SPUGNA BORDATA 100% COTONE

**DISPONIBILI IN 4 FORMATI:**

- cm 30x30 per mani
- cm 40x60 per intimo
- cm 60x110 per viso
- cm 100x150 per doccia



## PM940 LAVETTA

banda "easy print"  
25x2 cm ca



- 30x30 cm ca
- 10/100
- 420 gr SE

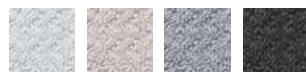

BI EC GR NE

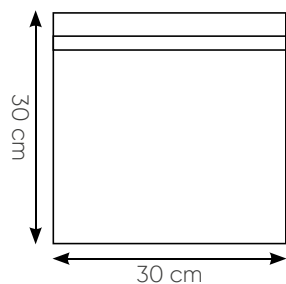

## PM942 INTIMO

banda "easy print"  
35x4 cm ca



- 40x60 cm ca
- 10/100
- 420 gr SE

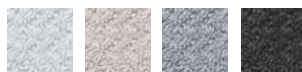

BI EC GR NE

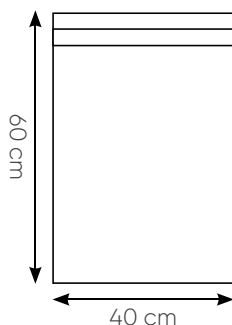

## PM944 VISO

banda "easy print"  
50x6 cm ca



- 60x110 cm ca
- 6/60
- 420 gr SE

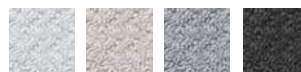

BI EC GR NE

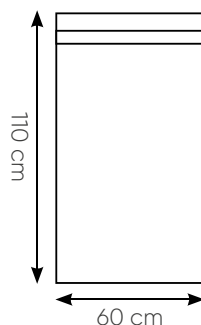

## PM946 DOCCIA

banda "easy print"  
80x8 cm ca



- 100x150 cm ca
- 3/24
- 420 gr SE

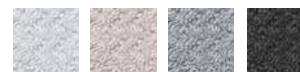

BI EC GR NE

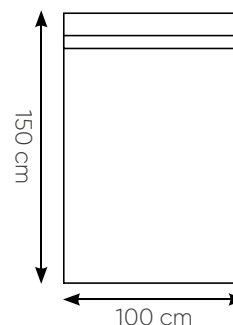

<b>GIFT</b>	
<b>A</b>	
Accendini	329-332
Apribottiglia	161-165, 323, 324
Asciugamani	453-457
Astuccio Portapenne	5
Asuccio per Tazza	141-142
Auricolari	346-349
<b>B</b>	
Basi di ricarica	339-345
Bavaglio Ristorante	152
Beauty case	295-303
Block Notes	71
Borracce in acciaio	116-130
Borracce in alluminio	131-135
Borracce in tritan	136
Borracce/Lattine	125, 128
Borsa P/Pizza	147
Borse P/Pranzo	144, 145
Borse P/Vino	148-151
Borse Mare	232-234
Borse da Viaggio	289
Borse P/computer e P/tablet	59, 62, 252-264, 270
Borse Portadocumenti	59-65
Borse Shopping in Carta	167-176
Borse Shopping in Cotone	221-249
Borse Shopping in Cotone Canvas	229-232
Borse Shopping in Cotone Organico	227-229
Borse Shopping in Cotone Riciclato	224-226
Borse Shopping in Juta	233-235
Borse Shopping in Poliestere	177, 189-191
Borse Shopping in Polietilene	196
Borse Shopping in Polipropilene	178-179
Borse Shopping TNT	192-220
Borse Shopping TNT Glitter	198
Borse Shopping TNT Laminato	197
Borse Shopping TNT RPET	192-195
Borse Termiche	180-188
Borsellino da Collo	81
Borsoni e Zaini Sport	282-287
Box Portabottiglie	148
Buste Portadocumenti	76, 77, 363-369
Buste Portavino	174
<b>C</b>	
Calendario da Scrivania	83, 86
Calendario Mousepad	111
Caricatori da Muro	352
Carrelli Spesa	177
Cartelle Sottobraccio	66-70
Cartelline Portablocco	70
Cavatappi	161-163
Cavi di Ricarica	355-357
Coltellini Multiuso	162, 163
Cuffie	346
<b>D</b>	
Dischi Orari	370, 371
Display in plexiglass	157-159
Doppi Metri	383
<b>E</b>	
Etichette per Valigia	291
<b>F</b>	
Fermacarte/Fermasoldi	75
Flaconi Spray	308
Flessometri	364
<b>G</b>	
Gancio Appendiborse	314
Gancio per Borracce	117, 119, 126, 130, 135, 137

Gilet	376, 450, 451
Grembiuli	153-156
<b>I</b>	
Impermeabili	400, 401
<b>K</b>	
Kit di ricarica per auto	352
Kit Fermatarga	372
<b>L</b>	
Lampada Caricabatterie	342
Lampada da Campeggio	309
Lampada USB	109, 342
Lanyard	78-81
Lente d'Ingrandimento	112
Lunch Bag	186-188
Lunch box	144, 145
<b>M</b>	
Marsupio	280
Matita in carta di giornale	54
Matita inesauribile	50
Matite	54-57, 385
Matite Sprout	55
Metri	383, 384
Mousepad	109-111, 343
<b>N</b>	
Necessaire da Viaggio	295-303
<b>O</b>	
Ombrelli	387-400
Ombrelli Antivento	388, 394, 397
Orologi smart	
<b>P</b>	
Panno Auto	376
Pastelli	52-54
Penne in Alluminio	6, 7, 13, 19, 20
Penne in Bamboo	8, 45-50
Penne in Caffè	50
Penne in Carta	43, 44, 50
Penne in Metallo	8-18
Penne in Paglia di Frumento	42-45
Penne in Plastica	21-41
Penne in Plastica Antibatterica	21-40
Penne Spray	21-23
Penne in RPET	51
Penne in Sughero	8, 45, 50, 51
Penne Touch	15-20, 22-28, 42, 44, 47-49
Poncho Antipioggia	401
Portabadge	78
Portabiglietti da Visita	72, 74, 75
Portabottiglia	148-151, 174
Portacalice con Tracolla in Tnt	152
Portacard/Portapatente	72-75, 377-382
Portachiavi Galleggianti	326, 327
Portachiavi in Ecopelle	312
Portachiavi in Legno	319-321
Portachiavi in Metallo	311-314, 324
Portachiavi in Plastica	315, 318, 322, 323, 325
Portachiavi in Poliestere	314, 325
Portachiavi in Poliuretano	311, 315, 316
Portachiavi portamonete	315, 316
Portacontrassegni per Auto	363-369
Portadocumenti da Viaggio	292-294
Portadocumenti per Farmacia	369
Portadocumenti per Auto	363-369
Portamonete	315, 316
Portamenù	157, 158, 160
Portapassaporto	292-294
Portapenne da Scrivania	82-84

Portapillole	308
Portapranzo	144, 145
Portatarga	372-375
Posacenere Tascabile	333
Post-it e Portafoglietti	86-89, 105-108
Powerbank	352-355
P/Carte da Scrivania	86-89, 105-108

<b>R</b>	
Radiosveglia	338
Rendiresto	159
Righelli	112, 113
Rolline Metriche	384

<b>S</b>	
Sacche zaino	222-224, 276-279
Scaldatazza	341
Scatola Portabottiglie	148
Sedia Pieghevole	309
Set da Viaggio	292
Set Matite e Pastelli	52-54, 57
Set Spazzola e Specchio	304
Smartwatch	335, 336
Sinalini	153-156
Speaker	335, 338, 350, 351
Spinner apribottiglia	164
Stilofofo	30
Stopmaster	384
Spazzole	304-307
Specchietti da Borsa	304-306
Stand di Ricarica Qi	339-345
Stazione Metereologica	337
Supporto Smartphone per Auto	361, 362
Svuotatasche	84, 85

<b>T</b>	
Tagliapizza	165
Taglierini	385
Targhette Valigia	291
Tappi per borracce	117, 119-123, 129, 130, 137
Tazze in Ceramica	138-140
Tazze in Vetro	141-143
Teli	453-457
Tracolle	59, 60, 62-65, 281
Trolley da Viaggio	289

<b>U</b>	
Umidificatore	337
USB Pen Drive	358, 359

<b>V</b>	
Ventagli	307

<b>Z</b>	
Zaini	251-279

## ABBIGLIAMENTO E TESSILE

<b>B</b>	
Bandane	425-427
Berretto Ciclista	424

<b>C</b>	
Camice	450
Canotta unisex	432
Cappelli	417-425, 427-429
Casacca	376, 450, 451
Costumi	433

<b>F</b>	
Fasce per Capelli	429, 430
Felpe	411-416, 438, 439

<b>G</b>	
Gilet	441, 444-446, 448, 449, 451
Giubbini	440-447

<b>I</b>	
Impermeabile	447

<b>P</b>	
Pantaloncino	432
Pile	416, 438, 439
Polo Adulto	408-410, 437
Polo Bambino	437

<b>S</b>	
Sciarpa	
Scaldacollo	

<b>T</b>	
T-Shirt Adulto	404-406, 431, 434, 435
T-Shirt Bambino	406, 407, 436
T-Shirt Donna	434

COD.	PAG.	COD.	PAG.	COD.	PAG.	COD.	PAG.	COD.	PAG.
CA026	251	PB582	99	PC417	122, 123	PC786	162	PD218	33
CA031	252	PB583	94	PC418	120, 121	PC801	164	PD335	34, 40
CA033	253	PB587	95	PC419	122, 123	PC812	164	PD343	33
CA035	254	PB588	96	PC421	126	PC815	165	PD346	35
CA037	255	PB589	97	PC426	132	PD011	7	PD348	36
CA039	256	PB594	100	PC427	132	PD022	8, 51	PD353	36, 40
CA043	257	PB599	101	PC428	129	PD025	6	PD384	37
CA046	258	PB600	102	PC430	131	PD026	6	PD388	37, 40
CA047	61	PB603	97	PC431	124	PD030	7	PD418	42
CA055	259	PB607	41	PC432	130	PD031	10	PD419	42
CA056	260	PB607	102	PC433	128	PD032	9	PD462	47
CA065	365	PB611	96	PC434	125	PD041	15	PD480	38
CA067	61	PB614	103	PC435	125	PD043	16	PD485	39
CA069	315	PB616	103	PC436	128	PD044	16	PD488	41
CA077	84	PB620	104	PC437	124	PD045	11	PD491	43
CA083	84	PB621	104	PC438	129	PD046	11	PD494	43
CA600	387	PC001	120, 121, 122,	PC456	151	PD048	12	PD495	44
CA650	397		123, 137	PC466	139	PD050	18	PD497	46
NK100	405	PC002	120, 121, 122,	PC467	140	PD051	12	PD499	46
NK101	406		123, 137	PC467NB	140	PD055	18	PD501	47
NK102	406	PC003	117, 119, 130, 137	PC478	143	PD058	15	PD503	47
NK103	407	PC004	117, 119, 126, 129,	PC484	133	PD062	13	PD504	47
NK150	404		130, 135, 137	PC487	152	PD063	13	PD505	48
NK151	404	PC085TR	157	PC490	134	PD071	21, 40	PD508	45
NK200	408	PC086TR	157	PC493	134	PD072	20	PD511	50
NK201	408	PC087TR	157	PC494	135	PD074	17	PD517	44
NK205	409	PC088TR	157	PC496	136	PD076	19	PD518	51
NK210	410	PC089TR	158	PC500	152	PD079	22	PD519	49
NK211	410	PC090TR	158	PC579	153	PD080	23	PD521	48
NK300	411	PC091TR	158	PC602	154	PD082	23	PD522	50
NK305	412	PC092TR	158	PC605	155	PD083	14	PD523	8, 50
NK310	413	PC290	138	PC606	154	PD088	20	PD524	49
NK315	414	PC295	138	PC607	156	PD089	24	PD525	45
NK320	415	PC365	141	PC608	156	PD090	25	PD527	49
NK325	416	PC370	142	PC670	160	PD091	25	PD529	8, 50
PA782	111	PC375	142	PC675	160	PD092	26	PD530	52
PA840	71	PC392	145	PC690	159	PD104	26	PD532	52
PA842	71	PC393	144	PC696TR	159	PD108	27	PD536	54
PA844	71	PC394	145	PC697TR	159	PD128	28	PD540	53
PB495	105	PC408	127	PC715	165	PD152	30	PD545	53
PB569	92	PC411	126	PC760	161	PD154	30	PD548	54
PB575	93	PC413	127	PC765	161	PD173	29	PD562	55
PB576	93	PC414	116-117	PC775	162	PD194	31	PD563	57
PB577	90	PC415	120, 121	PC780	163	PD207	29	PD565	55
PB581	98	PC416	118, 119	PC783	163	PD209	32, 40	PD566	55

COD.	PAG.	COD.	PAG.	COD.	PAG.	COD.	PAG.	COD.	PAG.
PD568	55	PE402	327	PF288	351	PG040	169	PG138	198
PD569	55	PE405	327	PF289	338	PG041	169	PG139	198
PD570	56	PE846	329	PF301	353	PG051	170	PG140	199
PD572	54	PE848	329	PF304	353	PG052	170	PG143	196
PD575	56	PE852	329	PF306	354	PG053	170	PG145	200
PD582	57	PE858	330	PF307	354	PG054	170	PG146	201
PD583	52	PE859	330	PF314	345	PG055	170	PG147	202
PE001	314	PE863	331	PF316	342	PG061	171	PG148	201
PE010	311	PE864	331	PF323	340	PG062	171	PG150	202
PE012	311	PE865	332	PF325	340	PG063	171	PG151	203
PE029	312	PE867	332	PF330	343	PG064	171	PG152	204
PE031	312	PE868	332	PF331	342	PG065	171	PG153	205
PE032	314	PE915	333	PF333	341	PG066	172	PG154	206
PE033	316	PF012	346	PF334	341	PG067	172	PG156	207
PE060	320	PF014-08	358	PF336	347	PG068	172	PG157	208
PE067	319	PF016	347	PF337	348	PG069	172	PG158	209
PE069	319	PF024	355	PF338	352	PG070	172	PG159	210
PE075	321	PF026	355	PF345	82	PG071	173	PG160	211
PE076	321	PF029	356	PF387	361	PG073	173	PG161	210
PE077	321	PF030	346	PF389	362	PG075	173	PG162	212
PE078	320	PF060	109	PF411	75	PG077	173	PG163	216
PE079	321	PF104-04	358	PF515	357	PG079	173	PG165	219
PE080	320	PF106-04	358	PF525	356	PG080	148	PG166	213
PE095	313	PF108-04	358	PF602	357	PG081	148	PG167	214
PE096	313	PF170	343	PG011	167	PG088	177	PG168	213
PE100	313	PF183	345	PG012	167	PG091	178	PG170	219
PE113	317	PF187	337	PG013	167	PG093	178	PG171	214
PE118	315	PF188	338	PG014	167	PG094	179	PG173	217
PE123	322	PF190	335	PG015	167	PG095	179	PG174	215
PE124	318	PF191	335	PG016	174	PG102	148	PG175	218
PE126	318	PF203	355	PG018	174	PG104	148	PG176	215
PE133	325	PF210	336	PG019	175	PG106	189	PG177	225
PE134	323	PF216	336	PG020	174	PG108	190	PG179	224
PE136	322	PF217	350	PG021	174	PG110	191	PG181	236
PE137	322	PF218	350	PG022	176	PG111	149	PG182	240
PE138	324	PF225	352	PG023	175	PG112	149	PG183	221
PE143	323	PF256	349	PG025	176	PG115	150	PG184	248
PE144	324	PF258	339	PG032	168	PG116	150	PG185	239
PE235	325	PF259	339	PG033	168	PG128	147	PG186	240
PE358	326	PF266	339	PG034	168	PG129	196	PG187	242
PE359	326	PF267	344	PG035	168	PG131	193	PG188	248
PE360	326	PF269	344	PG036	169	PG132	193	PG189	222
PE392	327	PF277	349	PG037	169	PG133	192	PG191	221
PE398	327	PF279	337	PG038	169	PG134	197	PG192	221
PE401	327	PF286	351	PG039	169	PG135	197	PG193	221



COD.	PAG.	COD.	PAG.	COD.	PAG.	COD.	PAG.	COD.	PAG.
PG194	245	PG401	220	PH222	59	PH640	108	PJ113	188
PG195	239	PG402	220	PH224	64	PH669	109	PJ200	309
PG196	227	PG406	244	PH225	64	PH670	110	PJ300	307
PG197	223	PG407	227	PH234	63	PH679	111	PJ504	79
PG198	227	PG420	240	PH240	65	PH701	85	PJ505	81
PG199	240	PG421	247	PH252	65	PH805	112	PJ506	80
PG200	241	PG422	229	PH265	203	PH810	112	PJ510	80
PG201	243	PG423	229	PH292	66	PH820	113	PJ560	81
PG202	245	PG424	229	PH300	67	PH823	113	PJ580	292
PG203	246	PG426	228	PH311	68	PI210	308	PJ582	293
PG206	241	PG433	227	PH315	68	PI225	308	PJ583	293
PG207	242	PG436	228	PH450	70	PI310	295	PJ585	294
PG210	240	PG437	225	PH455	70	PI311	296	PJ602	294
PG211	247	PG440	236	PH480	72	PI312	297	PJ650	291
PG213	241	PG441	237	PH482	73, 378	PI313	298	PJ700	291
PG214	249	PG446	151	PH485	73	PI314	298	PJ701	290
PG216	238	PG447	225	PH491	75	PI315	296	PJ705	292
PG218	289	PG448	151	PH502	76	PI318	299	PL085	388
PG235	270	PG450	230	PH504	76	PI320	299	PL087	389
PG240	271	PG451	230	PH507	77	PI321	300	PL089	389
PG241	234	PG452	238	PH510	77	PI322	300	PL091	387
PG242	233	PG453	237	PH523	78	PI330	301	PL102	390
PG244	235	PG455	232	PH530	78	PI333	301	PL105	390
PG245	233	PG456	232	PH544	78	PI334	302	PL107	391
PG246	234	PG462	194	PH545	78	PI335	302	PL109	392
PG248	235	PG463	194	PH547	82	PI337	303	PL112	393
PG251	270	PG465	195	PH550	82	PI340	303	PL113	394
PG261	276	PG466	195	PH551	83	PI351	304	PL119	395
PG265	282	PG468	192	PH553	83	PI360	308	PL124	392
PG267	283	PG477	226	PH555	83	PI395	304	PL127	396
PG271	284	PG480	279	PH585	86	PI415	305	PL129	398
PG273	285	PG487	231	PH590	86	PI490	305	PL131	398
PG274	286	PG499	231	PH593	87	PI521	306	PL134	399
PG278	277	PG500	261	PH598	87	PI522	306	PL135	399
PG279	276	PG501	262	PH606	88	PI525	307	PL136	400
PG280	278	PG502	263	PH615	88	PJ100	180	PL260	400
PG281	287	PG503	264	PH616	89	PJ102	181	PL270	401
PG293	272	PG513	265	PH617	91	PJ103	182	PL280	401
PG300	273	PG514	266	PH618	91	PJ104	183	PM090	417
PG310	274	PG516	267	PH619	106	PJ105	182	PM092	418
PG316	275	PG517	268	PH625	106	PJ106	183	PM093	419
PG361	280	PG521	269	PH630	107	PJ107	184	PM101	421
PG364	281	PH106	60	PH633	89	PJ108	185	PM102	420
PG367	281	PH204	59	PH635	107	PJ109	186	PM103	420
PG368	281	PH205	62	PH636	69	PJ112	187	PM105	422

COD.	PAG.	COD.	PAG.	COD.	PAG.	COD.	PAG.	COD.	PAG.
PM108	423	PM905	453	PN269	74, 377				
PM150	424	PM906	453	PN270	379				
PM155	424	PM911	454	PN272	379				
PM175	425	PM915	454	PN273	380				
PM185	425	PM921	455	PN274	380				
PM188	426	PM925	456	PN279	381				
PM189	426	PM930	457	PN280	381				
PM190	427	PM938	457	PN281	382				
PM192	427	PM940	458	PN282	382				
PM194	429	PM942	458	PN284	381				
PM197	428	PM944	458	PN300	384				
PM199	428	PM946	458	PN330	383				
PM202	429	PN045	362	PN351	383				
PM203	430	PN053	362	PN353	383				
PM210	431	PN057	361	PN354	383				
PM215	431	PN060	363	PN362	384				
PM220	432	PN065	364	PN364	384				
PM225	432	PN083	366	PN387	385				
PM252	433	PN085	364	PN388	385				
PM254	433	PN086	366	PN391	309				
PM301	434	PN098	367	PN450	385				
PM315	435	PN101	367	US001	359				
PM320	435	PN102	368	US002	359				
PM325	434	PN150	369	US003	359				
PM328	436	PN151	369	US004	359				
PM333	436	PN153	371	US005	359				
PM359	437	PN154	371	US006	359				
PM360	437	PN156	371	US007	359				
PM511	438	PN158	370	US008	359				
PM540	439	PN200	372	US009	359				
PM600	450	PN201	374	US010	359				
PM695	440	PN203	374	US011	359				
PM701	441	PN204	372	US012	359				
PM703	442	PN208	375	US013	359				
PM704	443	PN210	373	ZD253	5				
PM706	444	PN212	372	ZD260	5				
PM714	445	PN215	373						
PM716	446	PN220	373						
PM780	447	PN226	374						
PM809	448	PN227	374						
PM811	449	PN228	375						
PM815	450	PN230	375						
PM819	451	PN264	75, 378						
PM824	376, 451	PN265	376						
PM900	454	PN268	74, 377						

Questo catalogo è stampato su carta certificata FSC®



# Time.24



DICEMBRE 2023											
L	M	M	G	V	S	D					
					1	2	3				
					4	5	6	7	8	9	10
					11	12	13	14	15	16	17
					18	19	20	21	22	23	24
					25	26	27	28	29	30	31

FEBBRAIO 2024											
L	M	M	G	V	S	D					
					1	2	3	4			
					5	6	7	8	9	10	11
					12	13	14	15	16	17	18
					19	20	21	22	23	24	25
					26	27	28	29			

gen  
iona

2024

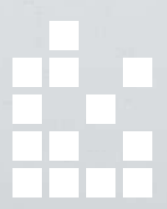

# Time.24

indice dei contenuti

**01** CALENDARI OLANDESI  
Fluo, trittici, passafoglio, olandesi classici, olandesi illustrati p. 03-34

**02** CALENDARI DA TAVOLO  
Calendari da tavolo, calendario mousepad p. 35-51

**03** ALMANACCO ITALIANO  
Calendari 12 fogli carta avorio, calendari da tavolo carta avorio p. 52-61

**04** CALENDARI ILLUSTRATI  
Calendari 12 fogli, calendari silhouette p. 62-90

**05** CALENDARI ILLUSTRATI DA TAVOLO  
Calendari da tavolo carta bianca p. 91-95

**06** PLANNING, BLOCCHI E INTERNI  
Planning da tavolo, blocchi per appunti, interni per agende p. 96-100

**07** AGENDE BLOCCO MOBILE  
Termoviranti, gommato, printflex, italy, tascabili, parure p. 101-117

**08** AGENDE BLOCCO FISSO  
Termoviranti, gommato, printflex, italy, tascabili, parure p. 118-183

**09** NOTES  
Parure notes e penna, notes p. 184-201



Gli articoli contrassegnati da questo simbolo sono realizzati con carta proveniente da materiale certificato FSC®, materiale riciclato e/o legno controllato.





formato  
19x14,5 cm ca



Festività  
Internazionali



3 colori fluo in sequenza alternata



**PA706 Fluo table**

Spiralato da tavolo mensile 13 fogli  
carta bianca 90 gr, supporto cartoncino bianco 450 gr



f.to calendario: 19x14,5 cm ca

f.to piedino: 19x3,5 cm ca

100



Tabella 2025  
in ultima  
pagina



DECEMBER DÉCEMBRE DEZEMBER								DICEMBRE 2023	
SETTIMANA WEEK WOCHE	LUNEDÌ MONDAY MONTAG	MARTEDÌ TUESDAY MARDI DIENSTAG	MERCOLEDÌ WEDNESDAY MERCREDI MITTWOCH	GIOVEDÌ THURSDAY JEUDI DONNERSTAG	VENERDÌ FRIDAY VENDREDI FREITAG	SABATO SATURDAY SAMEDI SAMSTAG	DOMENICA SUNDAY SONNTAG		
48					1	2	3		
49	4	5	6	7	8	9	10		
50	11	12	13	14	15	16	17		
51	18	19	20	21	22	23	24		
52	25	26	27	28	29	30	31		

JANUARY JANVIER JANUAR								GENNAIO 2024	
SETTIMANA WEEK WOCHE	LUNEDÌ MONDAY MONTAG	MARTEDÌ TUESDAY MARDI DIENSTAG	MERCOLEDÌ WEDNESDAY MERCREDI MITTWOCH	GIOVEDÌ THURSDAY JEUDI DONNERSTAG	VENERDÌ FRIDAY VENDREDI FREITAG	SABATO SATURDAY SAMEDI SAMSTAG	DOMENICA SUNDAY SONNTAG		
1	1	2	3	4	5	6	7		
2	8	9	10	11	12	13	14		
3	15	16	17	18	19	20	21		
4	22	23	24	25	26	27	28		
5	29	30	31						

FEBRUARY FÉVRIER FEBRUAR								FEBBRAIO 2024	
SETTIMANA WEEK WOCHE	LUNEDÌ MONDAY MONTAG	MARTEDÌ TUESDAY MARDI DIENSTAG	MERCOLEDÌ WEDNESDAY MERCREDI MITTWOCH	GIOVEDÌ THURSDAY JEUDI DONNERSTAG	VENERDÌ FRIDAY VENDREDI FREITAG	SABATO SATURDAY SAMEDI SAMSTAG	DOMENICA SUNDAY SONNTAG		
5				1	2	3	4		
6	5	6	7	8	9	10	11		
7	12	13	14	15	16	17	18		
8	19	20	21	22	23	24	25		
9	26	27	28	29					

DECEMBER DÉCEMBRE DEZEMBER								DICEMBRE 2023	
SETTIMANA WEEK WOCHE	LUNEDÌ MONDAY MONTAG	MARTEDÌ TUESDAY MARDI DIENSTAG	MERCOLEDÌ WEDNESDAY MERCREDI MITTWOCH	GIOVEDÌ THURSDAY JEUDI DONNERSTAG	VENERDÌ FRIDAY VENDREDI FREITAG	SABATO SATURDAY SAMEDI SAMSTAG	DOMENICA SUNDAY SONNTAG		
48					1	2	3		
49	4	5	6	7	8	9	10		
50	11	12	13	14	15	16	17		
51	18	19	20	21	22	23	24		
52	25	26	27	28	29	30	31		

JANUARY JANVIER JANUAR								GENNAIO 2024	
SETTIMANA WEEK WOCHE	LUNEDÌ MONDAY MONTAG	MARTEDÌ TUESDAY MARDI DIENSTAG	MERCOLEDÌ WEDNESDAY MERCREDI MITTWOCH	GIOVEDÌ THURSDAY JEUDI DONNERSTAG	VENERDÌ FRIDAY VENDREDI FREITAG	SABATO SATURDAY SAMEDI SAMSTAG	DOMENICA SUNDAY SONNTAG		
1	1	2	3	4	5	6	7		
2	8	9	10	11	12	13	14		
3	15	16	17	18	19	20	21		
4	22	23	24	25	26	27	28		
5	29	30	31						

FEBRUARY FÉVRIER FEBRUAR								FEBBRAIO 2024	
SETTIMANA WEEK WOCHE	LUNEDÌ MONDAY MONTAG	MARTEDÌ TUESDAY MARDI DIENSTAG	MERCOLEDÌ WEDNESDAY MERCREDI MITTWOCH	GIOVEDÌ THURSDAY JEUDI DONNERSTAG	VENERDÌ FRIDAY VENDREDI FREITAG	SABATO SATURDAY SAMEDI SAMSTAG	DOMENICA SUNDAY SONNTAG		
5				1	2	3	4		
6	5	6	7	8	9	10	11		
7	12	13	14	15	16	17	18		
8	19	20	21	22	23	24	25		
9	26	27	28	29					



formato  
33x79 cm ca

Carta  
Naturale



AR

VE

DECEMBER DÉCEMBRE DEZEMBER								DICEMBRE 2023	
SETTIMANA WEEK WOCHE	LUNEDÌ MONDAY MONTAG	MARTEDÌ TUESDAY MARDI DIENSTAG	MERCOLEDÌ WEDNESDAY MERCREDI MITTWOCH	GIOVEDÌ THURSDAY JEUDI DONNERSTAG	VENERDÌ FRIDAY VENDREDI FREITAG	SABATO SATURDAY SAMEDI SAMSTAG	DOMENICA SUNDAY SONNTAG		
48					1	2	3		
49	4	5	6	7	8	9	10		
50	11	12	13	14	15	16	17		
51	18	19	20	21	22	23	24		
52	25	26	27	28	29	30	31		

JANUARY JANVIER JANUAR								GENNAIO 2024	
SETTIMANA WEEK WOCHE	LUNEDÌ MONDAY MONTAG	MARTEDÌ TUESDAY MARDI DIENSTAG	MERCOLEDÌ WEDNESDAY MERCREDI MITTWOCH	GIOVEDÌ THURSDAY JEUDI DONNERSTAG	VENERDÌ FRIDAY VENDREDI FREITAG	SABATO SATURDAY SAMEDI SAMSTAG	DOMENICA SUNDAY SONNTAG		
1	1	2	3	4	5	6	7		
2	8	9	10	11	12	13	14		
3	15	16	17	18	19	20	21		
4	22	23	24	25	26	27	28		
5	29	30	31						

FEBRUARY FÉVRIER FEBRUAR								FEBBRAIO 2024	
SETTIMANA WEEK WOCHE	LUNEDÌ MONDAY MONTAG	MARTEDÌ TUESDAY MARDI DIENSTAG	MERCOLEDÌ WEDNESDAY MERCREDI MITTWOCH	GIOVEDÌ THURSDAY JEUDI DONNERSTAG	VENERDÌ FRIDAY VENDREDI FREITAG	SABATO SATURDAY SAMEDI SAMSTAG	DOMENICA SUNDAY SONNTAG		
5				1	2	3	4		
6	5	6	7	8	9	10	11		
7	12	13	14	15	16	17	18		
8	19	20	21	22	23	24	25		
9	26	27	28	29					

GI

### PA500 Trio

Trittico 3 blocchi dorsati e perforati  
carta naturale 70 gr, testata rinforzata  
corredato di cursore



- f.to calendario: 33x79 cm ca
- f.to testata: 33x20 cm ca
- 50



La carta proviene da materiale certificato FSC®, materiale riciclato e/o legno controllato.

formato 31x69 cm ca



Festività Internazionali

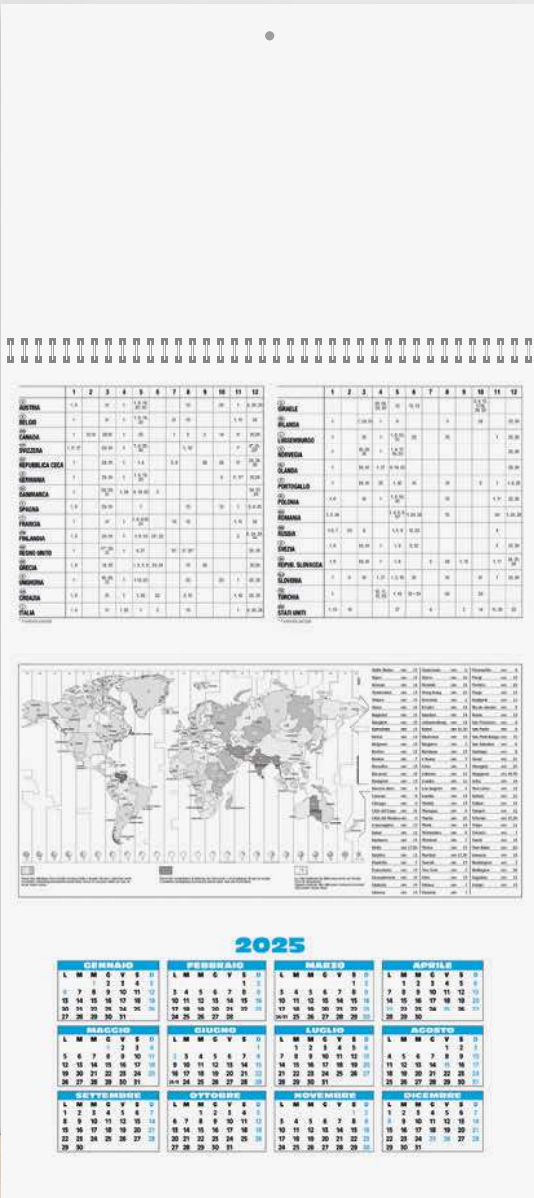

Supporto in cartoncino con: Festività Internazionali Fusi Orari & Tabella 2025

PA508 Spiral

Trittico 1 spirale trimestrale 12 fogli, carta naturale 70 gr cursore incluso già montato, testata e supporto in cartoncino 600 gr



- f.to calendario: 31x69 cm ca
- f.to testata: 31x20 cm ca
- 50

formato  
31x86 cm ca



La carta proviene da materiale certificato FSC®, materiale riciclato e/o legno controllato.

Festività Internazionali

**DICEMBRE 2023 DECEMBER**

Settimana Week	Lunedì Monday	Martedì Tuesday	Mercoledì Wednesday	Giovedì Thursday	Venerdì Friday	Sabato Saturday	Domenica Sunday
48					1	2	3
49	4	5	6	7	8	9	10
50	11	12	13	14	15	16	17
51	18	19	20	21	22	23	24
52	25	26	27	28	29	30	31

**GENNAIO 2024 JANUARY**

Settimana Week	Lunedì Monday	Martedì Tuesday	Mercoledì Wednesday	Giovedì Thursday	Venerdì Friday	Sabato Saturday	Domenica Sunday
1	1	2	3	4	5	6	7
2	8	9	10	11	12	13	14
3	15	16	17	18	19	20	21
4	22	23	24	25	26	27	28
5	29	30	31				

**FEBBRAIO 2024 FEBRUARY**

Settimana Week	Lunedì Monday	Martedì Tuesday	Mercoledì Wednesday	Giovedì Thursday	Venerdì Friday	Sabato Saturday	Domenica Sunday
5				1	2	3	4
6	5	6	7	8	9	10	11
7	12	13	14	15	16	17	18
8	19	20	21	22	23	24	25
9	26	27	28	29			

Supporto in cartoncino con:  
**Festività Internazionali**  
**Fusi Orari & Tabella 2025**

**PA510** Spiral Plus

Trittico 3 spirali trimestrale 12 fogli carta naturale 70 gr, cursore incluso già montato testata e supporto in cartoncino 600 gr



- f.to calendario: 31x86 cm ca
- f.to testata: 31x20 cm ca
- 50



formato 31x86 cm ca



La carta proviene da materiale certificato FSC®, materiale riciclato e/o legno controllato.

**NEW!**

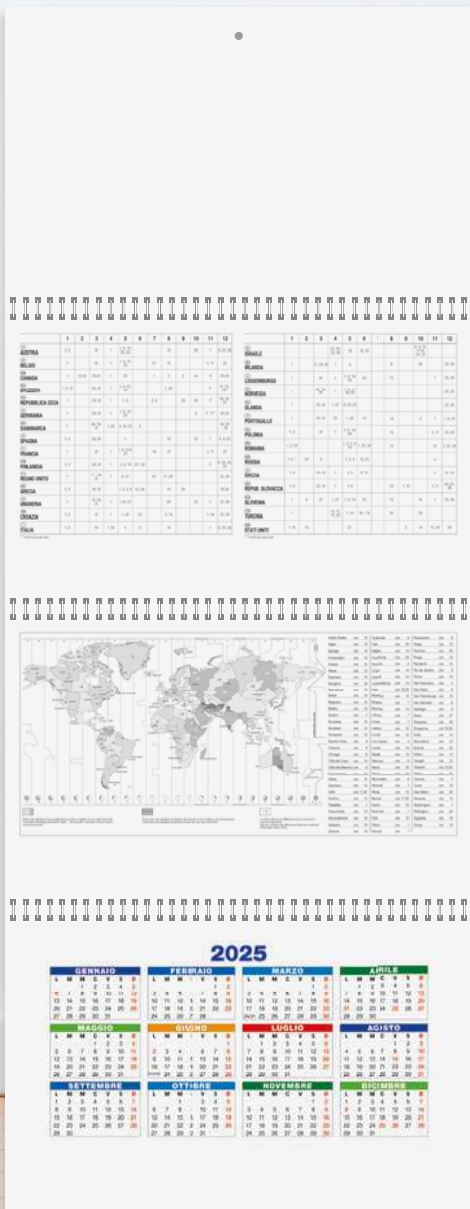

Supporto in cartoncino con:  
**Festività Internazionali**  
**Fusi Orari & Tabella 2025**

**PA516** Spiral Color

Trittico 3 spirali trimestrale 12 fogli carta naturale 70 gr, cursore incluso già montato testata e supporto in cartoncino 600 gr



- f.to calendario: 31x86 cm ca
- f.to testata: 31x20 cm ca
- 50



DECEMBER  
DECEMBRE  
DEZEMBER

## DICEMBRE 2023

SETTIMANA WEEK WOCHE	LUNEDÌ MONDAY MONTAG	MARTEDÌ TUESDAY DIENSTAG	MERCOLEDÌ WEDNESDAY MITTWOCH	GIOVEDÌ THURSDAY DONNERSTAG	VENERDÌ FRIDAY FREITAG	SABATO SATURDAY SAMSTAG	DOMENICA SUNDAY SONNTAG
48					1	2	3
49	4	5	6	7	8	9	10
50	11	12	13	14	15	16	17
51	18	19	20	21	22	23	24
52	25	26	27	28	29	30	31

JANUARY  
JANVIER  
JANUAR

## GENNAIO 2024

SETTIMANA WEEK WOCHE	LUNEDÌ MONDAY MONTAG	MARTEDÌ TUESDAY DIENSTAG	MERCOLEDÌ WEDNESDAY MITTWOCH	GIOVEDÌ THURSDAY DONNERSTAG	VENERDÌ FRIDAY FREITAG	SABATO SATURDAY SAMSTAG	DOMENICA SUNDAY SONNTAG
1	1	2	3	4	5	6	7
2	8	9	10	11	12	13	14
3	15	16	17	18	19	20	21
4	22	23	24	25	26	27	28
5	29	30	31				

FEBRUARY  
FEVRIER  
FEBRUAR

## FEBBRAIO 2024

SETTIMANA WEEK WOCHE	LUNEDÌ MONDAY MONTAG	MARTEDÌ TUESDAY DIENSTAG	MERCOLEDÌ WEDNESDAY MITTWOCH	GIOVEDÌ THURSDAY DONNERSTAG	VENERDÌ FRIDAY FREITAG	SABATO SATURDAY SAMSTAG	DOMENICA SUNDAY SONNTAG
5				1	2	3	4
6	5	6	7	8	9	10	11
7	12	13	14	15	16	17	18
8	19	20	21	22	23	24	25
9	26	27	28	29			

Testata Termosaldata

NEW!

GENNAIO		2024		♏
		CAPRICORNO		2312 - 2021
DIC 2023	<b>01</b> Lunedì	1-365	<b>17</b> Mercoledì	17-349
1 VEN	Maria Madre di Dio - Capodanno	01	s. Antonio abate	
2 SAB	<b>02</b> Martedì	2-364	<b>18</b> Giovedì	18-348
3 DOM	ss. Basilio e Gregorio		s. Liberata	
4 LUN	<b>03</b> Mercoledì	3-363	<b>19</b> Venerdì	19-347
5 MAR	s. Genoveffa		s. Mario	
6 MER	<b>04</b> Giovedì	4-362	<b>20</b> Sabato	20-346
7 GIO	ss. Ermes e Caio		ss. Sebastiano e Fabiano	
8 VEN	<b>05</b> Venerdì	5-361	<b>21</b> Domenica	21-345
9 SAB	s. Amelia		s. Agnese	
10 DOM	<b>06</b> Sabato	6-360	<b>22</b> Lunedì	22-344
11 LUN	Epifania di N.S.	06	s. Vincenzo	04
12 MAR	<b>07</b> Domenica	7-359	<b>23</b> Martedì	23-343
13 MER	Battesimo di Gesù		s. Emenenziana	
14 GIO	<b>08</b> Lunedì	8-358	<b>24</b> Mercoledì	24-342
15 VEN	s. Massimo	02	s. Francesco di Sales	
16 SAB	<b>09</b> Martedì	9-357	<b>25</b> Giovedì	25-341
17 DOM	s. Giuliano		Conversione di s. Paolo	
18 LUN	<b>10</b> Mercoledì	10-356	<b>26</b> Venerdì	26-340
19 MAR	s. Aldo		ss. Tito e Timoteo	
20 MER	<b>11</b> Giovedì	11-355	<b>27</b> Sabato	27-339
21 GIO	s. Iginio		s. Angela Merici	
22 VEN	<b>12</b> Venerdì	12-354	<b>28</b> Domenica	28-338
23 SAB	s. Cesira		s. Tommaso d'Aquino	
24 DOM	<b>13</b> Sabato	13-353	<b>29</b> Lunedì	29-337
25 LUN	s. Ilario		s. Costanzo	05
26 MAR	<b>14</b> Domenica	14-352	<b>30</b> Martedì	30-336
27 MER	s. Felice		s. Martina	
28 GIO	<b>15</b> Lunedì	15-351	<b>31</b> Mercoledì	31-335
29 VEN	s. Mauro	03	s. Giovanni Bosco	
30 SAB	<b>16</b> Martedì	16-350		
31 DOM	s. Marcello			

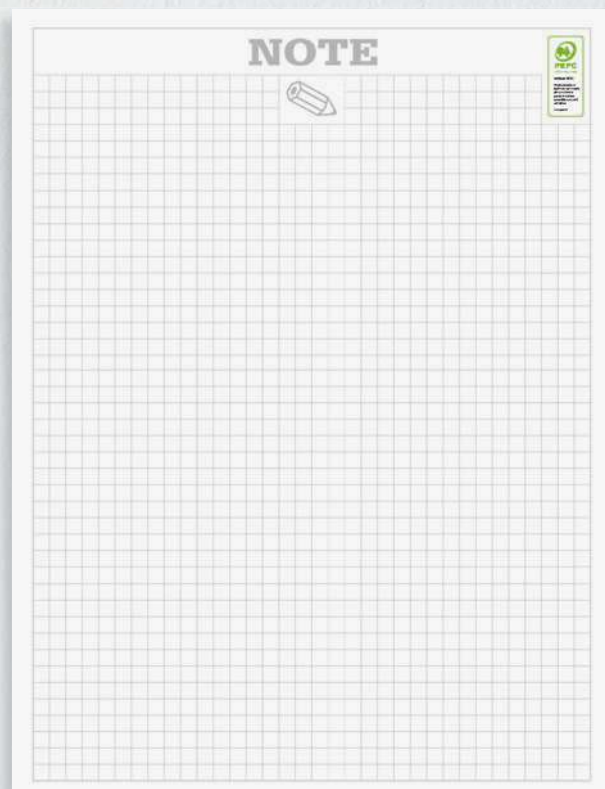

Retrostampato con pagina note



formato  
29x47 cm ca

Festività  
Internazionali

## PA420 Block

Olandese 12 fogli carta patinata 70 gr, testata termosaldata  
pagina note stampata sul retro



f.to calendario: 29x47 cm ca

f.to testata: 29x9 cm ca

100



NEW!

Testata Termosaldata

# GENNAIO 2024

DICEMBRE 2023						
Lun	Mar	Mer	Gio	Ven	Sab	Dom
				1	2	3
4	5	6	7	8	9	10
11	12	13	14	15	16	17
18	19	20	21	22	23	24
25	26	27	28	29	30	31

<p><b>1</b> lunedì Maria Madre di Dio - Capodanno 1-305</p> <p><b>2</b> martedì ss. Basilio e Gregorio 2-304</p> <p><b>3</b> mercoledì s. Genoveffa 3-303</p> <p><b>4</b> giovedì ss. Ermoto e Caio 4-302</p> <p><b>5</b> venerdì s. Amelia 5-301</p> <p><b>6</b> sabato Epifania di N.S. 6-300</p> <p><b>7</b> domenica Battesimo di Gesù 7-300</p> <p><b>8</b> lunedì s. Massimo 8-308</p> <p><b>9</b> martedì s. Giuliano 9-307</p> <p><b>10</b> mercoledì s. Aldo 10-306</p> <p><b>11</b> giovedì s. Igno 11-305</p> <p><b>12</b> venerdì s. Cesira 12-304</p> <p><b>13</b> sabato s. Ilario 13-303</p> <p><b>14</b> domenica s. Felice 14-302</p> <p><b>15</b> lunedì s. Mauro 15-301</p> <p><b>16</b> martedì s. Marcello 16-300</p>	<p><b>17</b> mercoledì s. Antonio abate 17-309</p> <p><b>18</b> giovedì s. Liberata 18-308</p> <p><b>19</b> venerdì s. Merio 19-307</p> <p><b>20</b> sabato ss. Sebastiano e Fabiano 20-306</p> <p><b>21</b> domenica s. Agnese 21-305</p> <p><b>22</b> lunedì s. Vincenzo 22-304</p> <p><b>23</b> martedì s. Emmerenziana 23-303</p> <p><b>24</b> mercoledì s. Francesco di Sales 24-302</p> <p><b>25</b> giovedì Conversione di s. Paolo 25-301</p> <p><b>26</b> venerdì ss. Tito e Timoteo 26-300</p> <p><b>27</b> sabato s. Angela Merici 27-309</p> <p><b>28</b> domenica s. Tommaso d'Aquino 28-308</p> <p><b>29</b> lunedì s. Costanzo 29-307</p> <p><b>30</b> martedì s. Martina 30-306</p> <p><b>31</b> mercoledì s. Giovanni Bosco 31-305</p>
--	---

FEBBRAIO 2024						
Lun	Mar	Mer	Gio	Ven	Sab	Dom
			1	2	3	4
5	6	7	8	9	10	11
12	13	14	15	16	17	18
19	20	21	22	23	24	25
26	27	28	29			

**Il Sole e la luna**

☀️ giorno 1 ore 7:37	🌙 ore 16:49	☀️ U.S. giorno 4 ore 4:30	🌙 U.S. giorno 11 ore 13:07
☀️ giorno 10 ore 7:07	🌙 ore 16:07	☀️ P.P. giorno 18 ore 4:54	🌙 P.P. giorno 20 ore 15:54

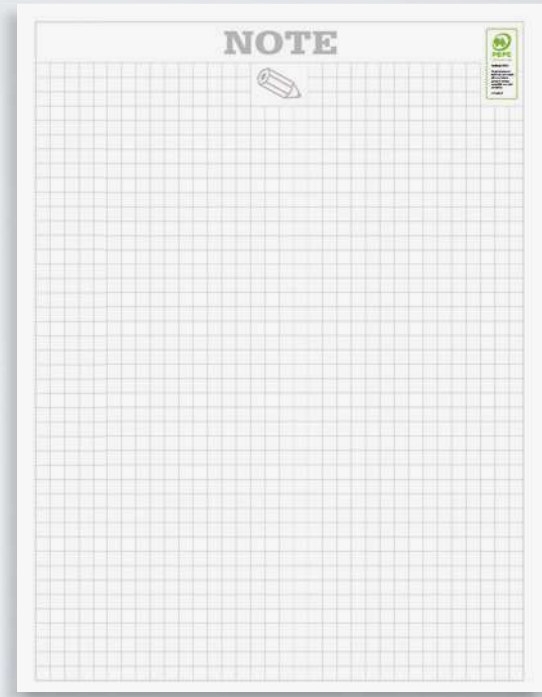

Retrostampato con pagina note

## PLANNING 2025

GENNAIO							FEBBRAIO							MARZO								
Lun	Mar	Mer	Gio	Ven	Sab	Dom	Lun	Mar	Mer	Gio	Ven	Sab	Dom	Lun	Mar	Mer	Gio	Ven	Sab	Dom		
			1	2	3	4	5						1	2							1	2
6	7	8	9	10	11	12	13	14	15	16	17	18	19	20	21	22	23	24	25	26	27	28
29	30	31																				

APRILE							MAGGIO							GIUGNO								
Lun	Mar	Mer	Gio	Ven	Sab	Dom	Lun	Mar	Mer	Gio	Ven	Sab	Dom	Lun	Mar	Mer	Gio	Ven	Sab	Dom		
			1	2	3	4	5	6	7	8	9	10	11	12	13	14	15	16	17	18	19	20
21	22	23	24	25	26	27	28	29	30													

LUGLIO							AGOSTO							SETTEMBRE								
Lun	Mar	Mer	Gio	Ven	Sab	Dom	Lun	Mar	Mer	Gio	Ven	Sab	Dom	Lun	Mar	Mer	Gio	Ven	Sab	Dom		
			1	2	3	4	5	6	7	8	9	10	11	12	13	14	15	16	17	18	19	20
21	22	23	24	25	26	27	28	29	30	31												

Ottobre							NOVEMBRE							DICEMBRE								
Lun	Mar	Mer	Gio	Ven	Sab	Dom	Lun	Mar	Mer	Gio	Ven	Sab	Dom	Lun	Mar	Mer	Gio	Ven	Sab	Dom		
			1	2	3	4	5	6	7	8	9	10	11	12	13	14	15	16	17	18	19	20
21	22	23	24	25	26	27	28	29	30	31												

NOTE						

Planning 2025 in ultima pagina

formato 29x47 cm ca

Festività Internazionali



**PA422 Multicolor Notes**

Olandese 12 fogli carta patinata 70 gr, testata termosaldata pagina note stampata sul retro

- 📄 f.to calendario: 29x47 cm ca
- 📄 f.to testata: 29x9 cm ca
- 📦 100



**NOTE**

**NEW!**

Testata Termosaldata

gennaio

**1 LUN** Maria Madre di Dio - Capodanno 1-300

**2 MAR** ss. Desiderio e Gregorio 2-294

**3 MER** s. Genovetta 3-303

**4 GIO** ss. Ermolao e Calisto 4-302

**5 VEN** s. Arnela 5-261

**6 SAB** Epifania di N.S. 6-300

**7 DOM** Battesimo di Gesù 7-309

**8 LUN** s. Massimo 8-308

**9 MAR** s. Giuliano 9-307

**10 MER** s. Aldo 10-306

**11 GIO** s. Ighino 11-305

**12 VEN** s. Cesio 12-304

**13 SAB** s. Ilario 13-303

**14 DOM** s. Felice 14-302

**15 LUN** s. Mauro 15-301

**16 MAR** s. Marcello 16-300

**MER 17** s. Antonio abate 17-300

**GIO 18** s. Lukanata 18-300

**VEN 19** s. Mario 19-307

**SAB 20** ss. Sebastiano e Fabiano 20-306

**DOM 21** s. Agnese 21-305

**LUN 22** s. Vincenzo 22-304

**MAR 23** s. Emerenziana 23-303

**MER 24** s. Francesco di Sales 24-302

**GIO 25** Conversione di s. Paolo 25-301

**VEN 26** ss. Tito e Timoteo 26-300

**SAB 27** s. Angela Merici 27-309

**DOM 28** s. Tommaso d'Aquino 28-308

**LUN 29** s. Costanzo 29-307

**MAR 30** s. Marina 30-306

**MER 31** s. Giovanni Bosco 31-305

2024

**Dicembre 2023**

Lunedì	Martedì	Mercoledì	Giovedì	Venerdì	Sabato	Domenica
4	5	6	7	8	9	10
11	12	13	14	15	16	17
18	19	20	21	22	23	24
25	26	27	28	29	30	31

**Febbraio 2024**

Lunedì	Martedì	Mercoledì	Giovedì	Venerdì	Sabato	Domenica
5	6	7	8	9	10	11
12	13	14	15	16	17	18
19	20	21	22	23	24	25
26	27	28	29			

Retrostampato con pagina note

formato 29x47 cm ca

Festività Internazionali



**PA430 Colors**

Olandese 12 fogli carta patinata 70 gr, testata termosaldada pagina note stampata sul retro



- f.to calendario: 29x47 cm ca
- f.to testata: 29x9 cm ca
- 100



Testata Termosaldata

NEW!

22/12 - 20/1

**GENNAIO 2024**

Dic 2023	GENNAIO 2024		Feb 2024
1 Ven	1 LUN	17 MER	1 Gio
2 Sab	2 MAR	18 GIO	2 Ven
3 Dom	3 MER	19 VEN	3 Sab
4 Lun	4 GIO	20 SAB	4 Dom
5 Mar	5 VEN	21 DOM	5 Lun
6 Mer	6 SAB	22 LUN	6 Mar
7 Gio	7 DOM	23 MAR	7 Mer
8 Ven	8 LUN	24 MER	8 Gio
9 Sab	9 MAR	25 GIO	9 Ven
10 Dom	10 MER	26 VEN	10 Sab
11 Lun	11 GIO	27 SAB	11 Dom
12 Mar	12 VEN	28 DOM	12 Lun
13 Mer	13 SAB	29 LUN	13 Mar
14 Gio	14 DOM	30 MAR	14 Mer
15 Ven	15 LUN	31 MER	15 Gio
16 Sab	16 MAR		16 Ven
17 Dom			17 Sab
18 Lun			18 Dom
19 Mar			19 Lun
20 Mer			20 Mar
21 Gio			21 Mer
22 Ven			22 Gio
23 Sab			23 Ven
24 Dom			24 Sab
25 Lun			25 Dom
26 Mar			26 Lun
27 Mer			27 Mar
28 Gio			28 Mer
29 Ven			29 Gio
30 Sab			
31 Dom			

**IL SOLE** **Sorge** **Tramonta** **LA LUNA**

Giorno 1 ore 5,37 ore 18,43 ☾ 11:00 giorno 8 ore 4,30

Giorno 10 ore 7,37 ore 18,37 ☽ 4:45 giorno 11 ore 12,57

Giorno 20 ore 7,32 ore 17,08 ☾ 3:45 giorno 18 ore 4,52

Nota: la data e l'ora sono da usare solo per orientamento. Il calendario non è un orologio.

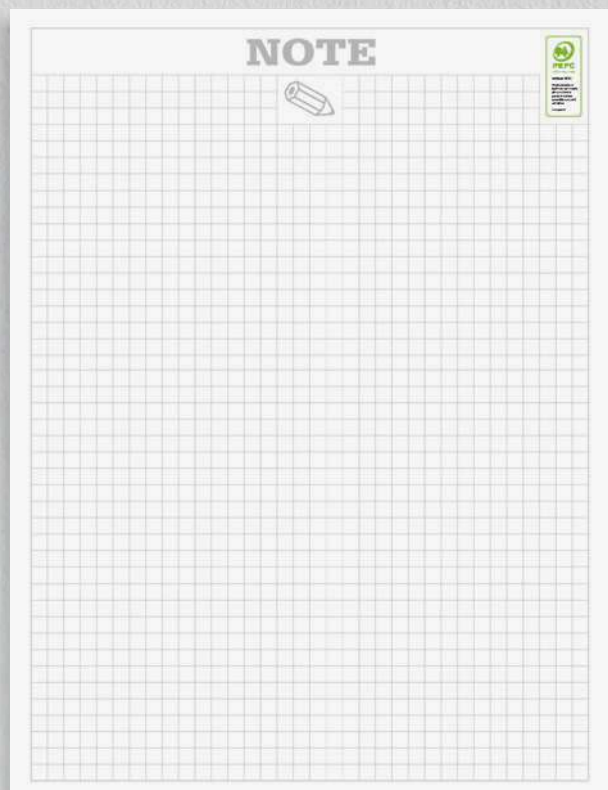

Retrostampato con pagina note

formato 29x47 cm ca

Festività Internazionali

**PA432 Italy**

Olandese 12 fogli carta patinata 70 gr, testata termosaldata pagina note stampata sul retro

- f.to calendario: 29x47 cm ca
- f.to testata: 29x9 cm ca
- 100



NEW!

Testata  
TermosaldataRetrostampato  
con pagina  
noteformato  
29x47 cm caFestività  
Internazionali

- f.to calendario: 29x47 cm ca
- f.to testata: 29x9 cm ca
- 100



**NEW!**

Testata Termosaldata



# GENNAIO

<p><b>1 LUN</b> Maria Madre di Dio - Capodanno 1-365</p> <p><b>2 MAR</b> ss. Basilio e Gregorio 1-364</p> <p><b>3 MER</b> s. Genoveffa 1-363</p> <p><b>4 GIO</b> ss. Ermes e Caio 1-362</p> <p><b>5 VEN</b> s. Amalia 1-361</p> <p><b>6 SAB</b> Epifania di N.S. 1-360</p> <p><b>7 DOM</b> Battesimo di Gesù 1-359</p> <p><b>8 LUN</b> s. Massimo 1-358</p> <p><b>9 MAR</b> s. Giuliano 1-357</p> <p><b>10 MER</b> s. Aldo 1-356</p> <p><b>11 GIO</b> s. Iginio 1-355</p> <p><b>12 VEN</b> s. Cesia 1-354</p> <p><b>13 SAB</b> s. Iario 1-353</p> <p><b>14 DOM</b> s. Felice 1-352</p> <p><b>15 LUN</b> s. Mauro 1-351</p> <p><b>16 MAR</b> s. Marcello 1-350</p>	<p>Statua della Libertà New York</p>	<p><b>17 MER</b> s. Antonio abate 17-347</p> <p><b>18 GIO</b> s. Liberato 18-348</p> <p><b>19 VEN</b> s. Mario 19-347</p> <p><b>20 SAB</b> ss. Sebastiano e Feliciano 20-344</p> <p><b>21 DOM</b> s. Agnese 21-345</p> <p><b>22 LUN</b> s. Vincenzo 22-344</p> <p><b>23 MAR</b> s. Emerenziana 23-343</p> <p><b>24 MER</b> s. Francesco di Sales 24-342</p> <p><b>25 GIO</b> Conversione di s. Paolo 25-341</p> <p><b>26 VEN</b> ss. Tito e Timoteo 26-340</p> <p><b>27 SAB</b> s. Angela Merici 27-339</p> <p><b>28 DOM</b> s. Tommaso d'Aquino 28-338</p> <p><b>29 LUN</b> s. Costanzo 29-337</p> <p><b>30 MAR</b> s. Marina 30-336</p> <p><b>31 MER</b> s. Giustino Donato 31-335</p>
---	--	--

4	5	6	7	1	2	3
11	12	13	14	15	16	17
18	19	20	21	22	23	24
25	26	27	28	29	30	31

2024

5	6	7	8	1	2	3
12	13	14	15	16	17	18
19	20	21	22	23	24	25
26	27	28	29			

Retrostampato con pagina note



formato 29x47 cm ca

Festività Internazionali

### PA455 Meraviglie del mondo

Olandese 12 fogli carta patinata 70 gr, testata termosaldada pagina note stampata sul retro



- f.to calendario: 29x47 cm ca
- f.to testata: 29x9 cm ca
- 100



NEW!

Testata Termosaldata

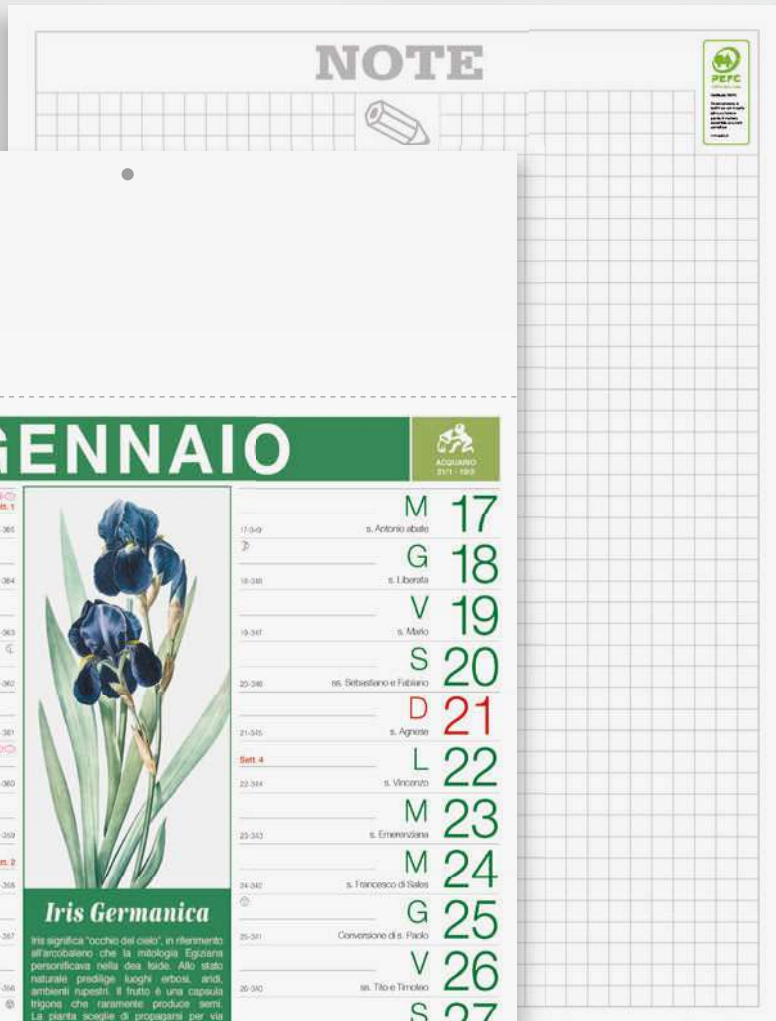

GENNAIO 2017 - 2019

# GENNAIO

AQUILINO 211 - 192

**1 L** Maria Madre di Dio - Capodanno 1-365

**2 M** ss. Basilio e Gregorio 1-364

**3 M** s. Genoveffa 1-365

**4 G** ss. Emidio e Cato 1-360

**5 V** s. Anniella 1-361

**6 S** Epifania di NS. 1-360

**7 D** Battesimo di Gesù 1-362

**8 L** s. Massimo 1-365

**9 M** s. Giuliano 1-367

**10 M** s. Aldo 0-366

**11 G** s. Igho 0-360

**12 V** s. Costia 0-364

**13 S** s. Sero 0-363

**14 D** s. Felice 0-362

**15 L** s. Misuro 0-361

**16 M** s. Marcato 0-360

**Iris Germanica**

La pianta sceglie di propagarsi per via vegetativa attraverso il rizoma, ed è proprio questo che si utilizza principalmente. Tutto la bellezza del fiore nasconde il suo profumo nel rizoma che lo rivela dopo l'essiccazione e la maturazione. La qualità cosmetiche di Iris sono ricche nell'acqua aromatica sia del rizoma che dai fiori. Può essere usata tal quale o sciolta come base per latti, creme e lozioni. I suoi rizomi che possono resistere ai grandi periodi di siccità dove accumulano acqua che poi ridonano alla pianta. Inizia così la pelle e immagazzinano acqua, a tratterla, soprattutto nelle pelli più secche e aride, favorisce i processi di autoregolazione cutanea. Facilita un'equilibrato approvvigionamento di liquore anche negli strati più profondi, stimolando la vitalità e quelli più esterni per una pelle più luminosa e levigata. Riporta (benica) rapida: morbida presenza, dona una pelle chiara e ammorbidita da un generale senso di rinascita e freschezza.

**M 17** s. Antonio abate 17-09

**G 18** s. Liborata 18-08

**V 19** s. Marco 19-347

**S 20** ss. Sebastiano e Feliciano 20-08

**D 21** s. Agnese 21-03

**L 22** s. Vincenzo 22-344

**M 23** s. Emmerenziana 23-362

**M 24** s. Francesco di Sales 24-047

**G 25** Conversione di Paolo 25-01

**V 26** ss. Tito e Tarcio 26-040

**S 27** s. Angela Merici 27-330

**D 28** s. Tommaso d'Aquino 28-305

**L 29** s. Costanzo 29-307

**M 30** s. Martina 30-336

**M 31** s. Silvestro 31-330

**DICEMBRE 2023**      **FEBBRAIO 2024**

Lunedì	Marcoledì	Venerdì	Sabato	Domenica	Lunedì	Marcoledì	Venerdì	Sabato	Domenica
4	5	6	7	8	5	6	7	8	9
11	12	13	14	15	12	13	14	15	16
18	19	20	21	22	19	20	21	22	23
25	26	27	28	29	26	27	28	29	



Retrostampato con pagina note

formato 29x47 cm ca

Festività Internazionali

**PA460 Erboristeria**

Olandese 12 fogli carta patinata 70 gr, testata termosaldata pagina note stampata sul retro



- f.to calendario: 29x47 cm ca
- f.to testata: 29x9 cm ca
- 100





**NEW!**

Testata Termosaldata

# NOTE



---



## GENNAIO





<table border="0" style="width: 100%;"> <tr><td style="width: 20px; font-weight: bold;">1</td><td style="font-weight: bold;">L</td><td style="font-size: small;">Maria Madre di Dio - Capodanno</td><td style="text-align: right; font-size: small;">1-365</td></tr> <tr><td>2</td><td>M</td><td>s. Basilio e Gregorio</td><td style="text-align: right;">1-364</td></tr> <tr><td>3</td><td>M</td><td>s. Ginevra</td><td style="text-align: right;">1-363</td></tr> <tr><td>4</td><td>G</td><td>s. Emidio e Cato</td><td style="text-align: right;">1-362</td></tr> <tr><td>5</td><td>V</td><td>s. Amelia</td><td style="text-align: right;">1-361</td></tr> <tr><td>6</td><td>S</td><td>Epifania di N.S.</td><td style="text-align: right;">1-360</td></tr> <tr><td>7</td><td>D</td><td>Battesimo di Gesù</td><td style="text-align: right;">1-359</td></tr> <tr><td>8</td><td>L</td><td>s. Massimo</td><td style="text-align: right;">1-358</td></tr> <tr><td>9</td><td>M</td><td>s. Giuliano</td><td style="text-align: right;">1-357</td></tr> <tr><td>10</td><td>M</td><td>s. Aldo</td><td style="text-align: right;">0-356</td></tr> <tr><td>11</td><td>G</td><td>s. Igino</td><td style="text-align: right;">0-355</td></tr> <tr><td>12</td><td>V</td><td>s. Costia</td><td style="text-align: right;">0-354</td></tr> <tr><td>13</td><td>S</td><td>s. Siro</td><td style="text-align: right;">0-353</td></tr> <tr><td>14</td><td>D</td><td>s. Felice</td><td style="text-align: right;">0-352</td></tr> <tr><td>15</td><td>L</td><td>s. Misuro</td><td style="text-align: right;">0-351</td></tr> <tr><td>16</td><td>M</td><td>s. Marzello</td><td style="text-align: right;">0-350</td></tr> </table>	1	L	Maria Madre di Dio - Capodanno	1-365	2	M	s. Basilio e Gregorio	1-364	3	M	s. Ginevra	1-363	4	G	s. Emidio e Cato	1-362	5	V	s. Amelia	1-361	6	S	Epifania di N.S.	1-360	7	D	Battesimo di Gesù	1-359	8	L	s. Massimo	1-358	9	M	s. Giuliano	1-357	10	M	s. Aldo	0-356	11	G	s. Igino	0-355	12	V	s. Costia	0-354	13	S	s. Siro	0-353	14	D	s. Felice	0-352	15	L	s. Misuro	0-351	16	M	s. Marzello	0-350	<table border="0" style="width: 100%;"> <tr><td style="width: 20px; font-weight: bold;">17</td><td style="font-weight: bold;">M</td><td>s. Antonio abate</td><td></td></tr> <tr><td>18</td><td>G</td><td>s. Liborata</td><td></td></tr> <tr><td>19</td><td>V</td><td>s. Marco</td><td></td></tr> <tr><td>20</td><td>S</td><td>ss. Sebastiano e Feliciano</td><td></td></tr> <tr><td>21</td><td>D</td><td>s. Agnese</td><td style="color: green;">21</td></tr> <tr><td>22</td><td>L</td><td>s. Vincenzo</td><td></td></tr> <tr><td>23</td><td>M</td><td>s. Emerenziana</td><td></td></tr> <tr><td>24</td><td>M</td><td>s. Francesco di Sales</td><td></td></tr> <tr><td>25</td><td>G</td><td>Conversione di s. Paolo</td><td></td></tr> <tr><td>26</td><td>V</td><td>ss. Tito e Tarcizio</td><td></td></tr> <tr><td>27</td><td>S</td><td>s. Angela Merici</td><td></td></tr> <tr><td>28</td><td>D</td><td>s. Tommaso d'Aquino</td><td style="color: green;">28</td></tr> <tr><td>29</td><td>L</td><td>s. Costanzo</td><td></td></tr> <tr><td>30</td><td>M</td><td>s. Martina</td><td></td></tr> <tr><td>31</td><td>M</td><td>s. Silvestro Papa</td><td></td></tr> </table>	17	M	s. Antonio abate		18	G	s. Liborata		19	V	s. Marco		20	S	ss. Sebastiano e Feliciano		21	D	s. Agnese	21	22	L	s. Vincenzo		23	M	s. Emerenziana		24	M	s. Francesco di Sales		25	G	Conversione di s. Paolo		26	V	ss. Tito e Tarcizio		27	S	s. Angela Merici		28	D	s. Tommaso d'Aquino	28	29	L	s. Costanzo		30	M	s. Martina		31	M	s. Silvestro Papa	
1	L	Maria Madre di Dio - Capodanno	1-365																																																																																																																										
2	M	s. Basilio e Gregorio	1-364																																																																																																																										
3	M	s. Ginevra	1-363																																																																																																																										
4	G	s. Emidio e Cato	1-362																																																																																																																										
5	V	s. Amelia	1-361																																																																																																																										
6	S	Epifania di N.S.	1-360																																																																																																																										
7	D	Battesimo di Gesù	1-359																																																																																																																										
8	L	s. Massimo	1-358																																																																																																																										
9	M	s. Giuliano	1-357																																																																																																																										
10	M	s. Aldo	0-356																																																																																																																										
11	G	s. Igino	0-355																																																																																																																										
12	V	s. Costia	0-354																																																																																																																										
13	S	s. Siro	0-353																																																																																																																										
14	D	s. Felice	0-352																																																																																																																										
15	L	s. Misuro	0-351																																																																																																																										
16	M	s. Marzello	0-350																																																																																																																										
17	M	s. Antonio abate																																																																																																																											
18	G	s. Liborata																																																																																																																											
19	V	s. Marco																																																																																																																											
20	S	ss. Sebastiano e Feliciano																																																																																																																											
21	D	s. Agnese	21																																																																																																																										
22	L	s. Vincenzo																																																																																																																											
23	M	s. Emerenziana																																																																																																																											
24	M	s. Francesco di Sales																																																																																																																											
25	G	Conversione di s. Paolo																																																																																																																											
26	V	ss. Tito e Tarcizio																																																																																																																											
27	S	s. Angela Merici																																																																																																																											
28	D	s. Tommaso d'Aquino	28																																																																																																																										
29	L	s. Costanzo																																																																																																																											
30	M	s. Martina																																																																																																																											
31	M	s. Silvestro Papa																																																																																																																											

DICEMBRE 2023							FEBBRAIO 2024						
Lunedì	Martedì	Mercoledì	Giovedì	Venerdì	Sabato	Domenica	Lunedì	Martedì	Mercoledì	Giovedì	Venerdì	Sabato	Domenica
4	5	6	7	8	9	10	5	6	7	8	9	10	11
11	12	13	14	15	16	17	12	13	14	15	16	17	18
18	19	20	21	22	23	24	19	20	21	22	23	24	25
25	26	27	28	29	30	31	26	27	28	29			

Retrostampato con pagina note

formato 29x47 cm ca

Festività Internazionali

**PA465 Wild Life**

Olandese 12 fogli carta patinata 70 gr, testata termosaldada pagina note stampata sul retro



- f.to calendario: 29x47 cm ca
- f.to testata: 29x9 cm ca
- 100

15

NEW!

Testata Termosaldata

# NOTE

---

**GENNAIO**

1 LUN Maria Madre di Dio - Capodanno 1-365

2 MAR ss. Basilio e Gregorio 1-364

3 MER s. Genoveffa 1-363

4 GIO ss. Ermate e Caio 1-362

5 VEN s. Amalia 1-361

6 SAB Epifania di N.S. 1-360

7 DOM Battesimo di Gesù 1-359

8 LUN s. Massimo 8-358

9 MAR s. Giuliano 8-357

10 MER s. Aldo 10-356

11 GIO s. Igino 11-355

12 VEN s. Cesia 11-354

13 SAB s. Iario 11-353

14 DOM s. Felice 11-352

15 LUN s. Mauro 11-351

16 MAR s. Marcella 11-350

17 MER s. Antonio abate 17-349

18 GIO s. Liberato 18-348

19 VEN s. Mario 19-347

20 SAB ss. Sebastiano e Fabiano 20-346

21 DOM s. Agnese 21-345

22 LUN s. Vincenzo 22-344

23 MAR s. Emerenziana 23-343

24 MER s. Francesco di Sales 24-342

25 GIO Conversione di s. Paolo 25-341

26 VEN ss. Tito e Timoteo 26-340

27 SAB s. Angela Merici 27-339

28 DOM s. Tommaso d'Aquino 28-338

29 LUN s. Costanzo 29-337

30 MAR s. Martina 30-336

31 MER s. Giustino Donato 31-335



**CIRCUITO DI MONZA**



**FORMULA 1**

DICEMBRE 2023						
Lunedì	Martedì	Mercoledì	Giovedì	Venerdì	Sabato	Domenica
4	5	6	7	8	9	10
11	12	13	14	15	16	17
18	19	20	21	22	23	24
25	26	27	28	29	30	31

# 2024

FEBBRAIO 2024						
Lunedì	Martedì	Mercoledì	Giovedì	Venerdì	Sabato	Domenica
5	6	7	8	9	10	11
12	13	14	15	16	17	18
19	20	21	22	23	24	25
26	27	28	29			

Retrostampato con pagina note



formato 29x47 cm ca

Festività Internazionali

**PA468 Corse**

Olandese 12 fogli carta patinata 70 gr, testata termosaldada pagina note stampata sul retro



- f.to calendario: 29x47 cm ca
- f.to testata: 29x9 cm ca
- 100



formato  
31x53,5 cm ca

Festività  
Internazionali

Testata Extrastrong



# GENNAIO 2024

dic 2023	GENNAIO 2024		feb 2024
1 Ven	<b>1 LUN</b> s. Maria Madre di Dio - Capodanno	<b>17 MER</b> s. Antonio abate	1 Gio
2 Sab	<b>2 MAR</b> ss. Basilio e Griselda	<b>18 GIO</b> s. Liberata	2 Ven
3 Dom	<b>3 MER</b> s. Genoveffa	<b>19 VEN</b> s. Maria	3 Sab
4 Lun	<b>4 GIO</b> ss. Emerico e Cal	<b>20 SAB</b> ss. Sebastiano e Fabiano	4 Dom
5 Mar	<b>5 VEN</b> s. Amelia	<b>21 DOM</b> s. Agnese	5 Lun
6 Mer	<b>6 SAB</b> Epifania di Gesù	<b>22 LUN</b> s. Vincenzo	6 Mar
7 Gio	<b>7 DOM</b> Battesimo di Gesù	<b>23 MAR</b> s. Eusebio	7 Mer
8 Ven	<b>8 LUN</b> s. Massimo	<b>24 MER</b> s. Francesco Sales	8 Gio
9 Sab	<b>9 MAR</b> s. Giuliano	<b>25 GIO</b> Conversioni di s. Paolo	9 Ven
10 Dom	<b>10 MER</b> s. Aldo	<b>26 VEN</b> ss. Tito e Tazoto	10 Sab
11 Lun	<b>11 GIO</b> s. Agostino	<b>27 SAB</b> s. Angela Merici	11 Dom
12 Mar	<b>12 VEN</b> s. Cesia	<b>28 DOM</b> s. Tommaso d'Aquino	12 Lun
13 Mer	<b>13 SAB</b> s. Bartolomeo	<b>29 LUN</b> s. Costanzo	13 Mar
14 Gio	<b>14 DOM</b> s. Felice	<b>30 MAR</b> s. Martina	14 Mer
15 Ven	<b>15 LUN</b> s. Nazario	<b>31 MER</b> s. Giovanni Bosco	15 Gio
16 Sab	<b>16 MAR</b> s. Marcello		16 Ven
17 Dom			17 Sab
18 Lun			18 Dom
19 Mar			19 Lun
20 Mer			20 Mar
21 Gio			21 Mer
22 Ven			22 Gio
23 Sab			23 Ven
24 Dom			24 Sab
25 Lun			25 Dom
26 Mar			26 Lun
27 Mer			27 Mar
28 Gio			28 Mer
29 Ven			29 Gio
30 Sab			
31 Dom			

BL

## GENNAIO 2024

dic 2023	GENNAIO 2024		feb 2024
1 Ven	<b>1 LUN</b>	<b>17 MER</b>	1 Gio
2 Sab	<b>2 MAR</b>	<b>18 GIO</b>	2 Ven
3 Dom	<b>3 MER</b>	<b>19 VEN</b>	3 Sab
4 Lun	<b>4 GIO</b>	<b>20 SAB</b>	4 Dom
5 Mar	<b>5 VEN</b>	<b>21 DOM</b>	5 Lun
6 Mer	<b>6 SAB</b>	<b>22 LUN</b>	6 Mar
7 Gio	<b>7 DOM</b>	<b>23 MAR</b>	7 Mer
8 Ven	<b>8 LUN</b>	<b>24 MER</b>	8 Gio
9 Sab	<b>9 MAR</b>	<b>25 GIO</b>	9 Ven
10 Dom	<b>10 MER</b>	<b>26 VEN</b>	10 Sab
11 Lun	<b>11 GIO</b>	<b>27 SAB</b>	11 Dom
12 Mar	<b>12 VEN</b>	<b>28 DOM</b>	12 Lun
13 Mer	<b>13 SAB</b>	<b>29 LUN</b>	13 Mar
14 Gio	<b>14 DOM</b>	<b>30 MAR</b>	14 Mer
15 Ven	<b>15 LUN</b>	<b>31 MER</b>	15 Gio
16 Sab	<b>16 MAR</b>		16 Ven
17 Dom			17 Sab
18 Lun			18 Dom
19 Mar			19 Lun
20 Mer			20 Mar
21 Gio			21 Mer
22 Ven			22 Gio
23 Sab			23 Ven
24 Dom			24 Sab
25 Lun			25 Dom
26 Mar			26 Lun
27 Mer			27 Mar
28 Gio			28 Mer
29 Ven			29 Gio
30 Sab			
31 Dom			

RO

## GENNAIO 2024

dic 2023	GENNAIO 2024		feb 2024
1 Ven	<b>1 LUN</b>	<b>17 MER</b>	1 Gio
2 Sab	<b>2 MAR</b>	<b>18 GIO</b>	2 Ven
3 Dom	<b>3 MER</b>	<b>19 VEN</b>	3 Sab
4 Lun	<b>4 GIO</b>	<b>20 SAB</b>	4 Dom
5 Mar	<b>5 VEN</b>	<b>21 DOM</b>	5 Lun
6 Mer	<b>6 SAB</b>	<b>22 LUN</b>	6 Mar
7 Gio	<b>7 DOM</b>	<b>23 MAR</b>	7 Mer
8 Ven	<b>8 LUN</b>	<b>24 MER</b>	8 Gio
9 Sab	<b>9 MAR</b>	<b>25 GIO</b>	9 Ven
10 Dom	<b>10 MER</b>	<b>26 VEN</b>	10 Sab
11 Lun	<b>11 GIO</b>	<b>27 SAB</b>	11 Dom
12 Mar	<b>12 VEN</b>	<b>28 DOM</b>	12 Lun
13 Mer	<b>13 SAB</b>	<b>29 LUN</b>	13 Mar
14 Gio	<b>14 DOM</b>	<b>30 MAR</b>	14 Mer
15 Ven	<b>15 LUN</b>	<b>31 MER</b>	15 Gio
16 Sab	<b>16 MAR</b>		16 Ven
17 Dom			17 Sab
18 Lun			18 Dom
19 Mar			19 Lun
20 Mer			20 Mar
21 Gio			21 Mer
22 Ven			22 Gio
23 Sab			23 Ven
24 Dom			24 Sab
25 Lun			25 Dom
26 Mar			26 Lun
27 Mer			27 Mar
28 Gio			28 Mer
29 Ven			29 Gio
30 Sab			
31 Dom			

VE

### PA520 Gigante

Olandese 12 fogli carta naturale 70 gr  
testata fustellata rinforzata triplo strato



- f.to calendario: 31x53,5 cm ca
- f.to testata: 31x10,5 cm ca
- 100



La carta proviene da materiale certificato FSC®, materiale riciclato e/o legno controllato.



Testata  
Extrastrong



Testata  
Extrastrong



La carta proviene da  
materiale certificato FSC®,  
materiale riciclato e/o legno  
controllato.

formato  
33x71 cm ca



Festività  
Internazionali



BL

RO

## PA523 Magnum

Olandese 12 fogli carta naturale 70 gr  
testata fustellata rinforzata triplo strato



f.to calendario: 33x71 cm ca

f.to testata: 33x11 cm ca

50

CAPRICORNO  
22/12 - 20/1

# GENNAIO 2024

ACQUARIO  
21/1 - 19/2

D	1	LUNEDÌ	1° sett.						
	1 v	Maria Madre di Dio - Capodanno							
	2 s	MARTEDÌ							
3	D	ss. Basilio e Gregorio							
	4 L	MERCOLEDÌ							
	5 M	s. Genoveffa							
	6 M	GIOVEDÌ							
	7 G	ss. Ermete e Calo							
8	V	VENERDÌ							
	9 S	s. Amelia							
10	D	SABATO							
	11 L	Epifania di N.S.							
	12 M	DOMENICA							
	13 M	Battesimo di Gesù							
	14 G	LUNEDÌ	2° sett.						
	15 V	s. Massimo							
	16 S	MARTEDÌ							
17	D	s. Giuliano							
	18 L	MERCOLEDÌ							
	19 M	s. Aldo							
	20 M	GIOVEDÌ							
	21 G	s. Iginio							
	22 V	MERCOLEDÌ							
	23 S	s. Cesira							
24	D	SABATO							
	25 L	s. Ilario							
	26 M	DOMENICA							
	27 M	s. Felice							
	28 G	LUNEDÌ	3° sett.						
	29 V	s. Mauro							
	30 S	MARTEDÌ							
31	D	s. Marcello							

**IL SOLE**    Sorgo    Tramonta

Giorno 1    ore 7,37    ore 16,49

Giorno 10    ore 7,37    ore 16,57

Giorno 20    ore 7,32    ore 17,09

NOTA: la luce e il tramonto del sole riportati nel calendario si riferiscono sempre all'ora solare.

**LA LUNA**    ☾ U.O.    ☽

Giorno 4    ore 4,30

☾ L.N.    ☽ L.N.    ☽ L.N.    ☽ L.N.

Giorno 11    ore 12,57

☽ P.Q.    ☽ P.Q.    ☽ P.Q.    ☽ P.Q.

Giorno 18    ore 4,52

☽ L.P.    ☽ L.P.    ☽ L.P.    ☽ L.P.

Giorno 25    ore 18,54

formato 34x53,5 cm ca

Festività Internazionali

Testata Extrastrong

**2024 GENNAIO** CARICORNO 22/12 - 20/1

DICEMBRE 2023	1 VEN 2 SAB 3 DOM 4 LUN 5 MAR 6 MER 7 GIO 8 VEN 9 SAB 10 DOM 11 LUN 12 MAR 13 MER 14 GIO 15 VEN 16 SAB 17 DOM 18 LUN 19 MAR 20 MER 21 GIO 22 VEN 23 SAB 24 DOM 25 LUN 26 MAR 27 MER 28 GIO 29 VEN 30 SAB 31 DOM	<b>1 LUN</b> <small>Madalena di Dio - Disposizione</small> <b>2 MAR</b> <small>St. Basilio - Digheolo</small> <b>3 MER</b> <small>S. Vincenz.</small> <b>4 GIO</b> <small>S. Eufemia - Cava</small> <b>5 VEN</b> <small>S. Maria</small> <b>6 SAB</b> <small>Epifania di R.S.</small> <b>7 DOM</b> <small>Epifania di Gemo</small> <b>8 LUN</b> <small>S. Antonio</small> <b>9 MAR</b> <small>S. Giorgio</small> <b>10 MER</b> <small>S. Pio</small> <b>11 GIO</b> <small>S. Agost.</small> <b>12 VEN</b> <small>S. Cleo.</small> <b>13 SAB</b> <small>S. Rocco</small> <b>14 DOM</b> <small>S. Fede.</small> <b>15 LUN</b> <small>S. Mateo</small> <b>16 MAR</b> <small>S. Moritz</small>	<b>17 MER</b> <small>S. Antonio Pad.</small> <b>18 GIO</b> <small>S. Cleo.</small> <b>19 VEN</b> <small>S. Maria</small> <b>20 SAB</b> <small>S. Calisto e Crispin.</small> <b>21 DOM</b> <small>S. Agost.</small> <b>22 LUN</b> <small>S. Vincenzo</small> <b>23 MAR</b> <small>S. Ermeneg.</small> <b>24 MER</b> <small>S. Francesco di Sales</small> <b>25 GIO</b> <small>Conversione di S. Paolo</small> <b>26 VEN</b> <small>S. Vito - Biadene</small> <b>27 SAB</b> <small>S. Agost. Mos.</small> <b>28 DOM</b> <small>S. Francesco d'Ass.</small> <b>29 LUN</b> <small>S. Costanz.</small> <b>30 MAR</b> <small>S. Matia</small> <b>31 MER</b> <small>S. Giovanni Batt.</small>	FEBBRAIO 2024	1 GIO 2 VEN 3 SAB 4 DOM 5 LUN 6 MAR 7 MER 8 GIO 9 VEN 10 SAB 11 DOM 12 LUN 13 MAR 14 MER 15 GIO 16 VEN 17 SAB 18 DOM 19 LUN 20 MAR 21 MER 22 GIO 23 VEN 24 SAB 25 DOM 26 LUN 27 MAR 28 MER 29 GIO
---------------	---	---	--	---------------	---

COMPRESA DI PUBBLICITÀ, NEL RISPETTO DEL VEDERE AMBITO LOCALE, È IL GARANTO DI UNO DEI NOSTRI PRODOTTI

RO

**2024 GENNAIO**

DICEMBRE 2023	1 VEN 2 SAB 3 DOM 4 LUN 5 MAR 6 MER 7 GIO 8 VEN 9 SAB 10 DOM 11 LUN 12 MAR 13 MER 14 GIO 15 VEN 16 SAB 17 DOM 18 LUN 19 MAR 20 MER 21 GIO 22 VEN 23 SAB 24 DOM 25 LUN 26 MAR 27 MER 28 GIO 29 VEN 30 SAB 31 DOM	<b>1 LUN</b> <b>2 MAR</b> <b>3 MER</b> <b>4 GIO</b> <b>5 VEN</b> <b>6 SAB</b> <b>7 DOM</b> <b>8 LUN</b> <b>9 MAR</b> <b>10 MER</b> <b>11 GIO</b> <b>12 VEN</b> <b>13 SAB</b> <b>14 DOM</b> <b>15 LUN</b> <b>16 MAR</b>	<b>17 MER</b> <b>18 GIO</b> <b>19 VEN</b> <b>20 SAB</b> <b>21 DOM</b> <b>22 LUN</b> <b>23 MAR</b> <b>24 MER</b> <b>25 GIO</b> <b>26 VEN</b> <b>27 SAB</b> <b>28 DOM</b> <b>29 LUN</b> <b>30 MAR</b> <b>31 MER</b>	FEBBRAIO 2024	1 GIO 2 VEN 3 SAB 4 DOM 5 LUN 6 MAR 7 MER 8 GIO 9 VEN 10 SAB 11 DOM 12 LUN 13 MAR 14 MER 15 GIO 16 VEN 17 SAB 18 DOM 19 LUN 20 MAR 21 MER 22 GIO 23 VEN 24 SAB 25 DOM 26 LUN 27 MAR 28 MER 29 GIO
---------------	---	---	---	---------------	---

BL

**2024 GENNAIO**

DICEMBRE 2023	1 VEN 2 SAB 3 DOM 4 LUN 5 MAR 6 MER 7 GIO 8 VEN 9 SAB 10 DOM 11 LUN 12 MAR 13 MER 14 GIO 15 VEN 16 SAB 17 DOM 18 LUN 19 MAR 20 MER 21 GIO 22 VEN 23 SAB 24 DOM 25 LUN 26 MAR 27 MER 28 GIO 29 VEN 30 SAB 31 DOM	<b>1 LUN</b> <b>2 MAR</b> <b>3 MER</b> <b>4 GIO</b> <b>5 VEN</b> <b>6 SAB</b> <b>7 DOM</b> <b>8 LUN</b> <b>9 MAR</b> <b>10 MER</b> <b>11 GIO</b> <b>12 VEN</b> <b>13 SAB</b> <b>14 DOM</b> <b>15 LUN</b> <b>16 MAR</b>	<b>17 MER</b> <b>18 GIO</b> <b>19 VEN</b> <b>20 SAB</b> <b>21 DOM</b> <b>22 LUN</b> <b>23 MAR</b> <b>24 MER</b> <b>25 GIO</b> <b>26 VEN</b> <b>27 SAB</b> <b>28 DOM</b> <b>29 LUN</b> <b>30 MAR</b> <b>31 MER</b>	FEBBRAIO 2024	1 GIO 2 VEN 3 SAB 4 DOM 5 LUN 6 MAR 7 MER 8 GIO 9 VEN 10 SAB 11 DOM 12 LUN 13 MAR 14 MER 15 GIO 16 VEN 17 SAB 18 DOM 19 LUN 20 MAR 21 MER 22 GIO 23 VEN 24 SAB 25 DOM 26 LUN 27 MAR 28 MER 29 GIO
---------------	---	---	---	---------------	---

VE

PA550 Passafoglio

Olandese 12 fogli carta naturale 70 gr testata fustellata rinforzata triplo strato



- f.to calendario: 34x53,5 cm ca
- f.to testata: 34x12 cm ca
- 100



La carta proviene da materiale certificato FSC®, materiale riciclato e/o legno controllato.



Testata Extrastrong

Testata Termosaldata

GENNAIO 2024		
<b>1</b> Ven	<b>1</b> LUNEDÌ Maria Madre di Dio - Capodanno	<b>17</b> MERCOLEDÌ s. Antonio abate
<b>2</b> Sab	<b>2</b> MARTEDÌ ss. Basilio e Gregorio	<b>18</b> GIOVEDÌ s. Libera
<b>3</b> Dom	<b>3</b> MERCOLEDÌ s. Genoveffa	<b>19</b> VENERDÌ s. Mario
<b>4</b> Lun	<b>4</b> GIOVEDÌ ss. Ermete e Calo	<b>20</b> SABATO ss. Sebastiano e Fabiano
<b>5</b> Mar	<b>5</b> VENERDÌ s. Annela	<b>21</b> DOMENICA s. Agnese
<b>6</b> Mer	<b>6</b> SABATO Epifania di N.S.	<b>22</b> LUNEDÌ s. Vincerzo
<b>7</b> Gio	<b>7</b> DOMENICA Raffaello di Casal	<b>23</b> MARTEDÌ s. Emmerenziana
<b>8</b> Ven	<b>8</b> LUNEDÌ s. Massimo	<b>24</b> MERCOLEDÌ s. Francesco di Sales
<b>9</b> Sab	<b>9</b> MARTEDÌ s. Giuliano	<b>25</b> GIOVEDÌ Conversione di s. Paolo
<b>10</b> Dom	<b>10</b> MERCOLEDÌ s. Aldo	<b>26</b> VENERDÌ ss. Tito e Timoteo
<b>11</b> Lun	<b>11</b> GIOVEDÌ s. Igho	<b>27</b> SABATO s. Angeli Meric
<b>12</b> Mar	<b>12</b> VENERDÌ s. Cesira	<b>28</b> DOMENICA s. Tommaso d'Aquino
<b>13</b> Mer	<b>13</b> SABATO s. Ilario	<b>29</b> LUNEDÌ s. Costanzo
<b>14</b> Gio	<b>14</b> DOMENICA s. Felice	<b>30</b> MARTEDÌ s. Martina
<b>15</b> Ven	<b>15</b> LUNEDÌ s. Mauro	<b>31</b> MERCOLEDÌ s. Giovanni Bosco
<b>16</b> Sab	<b>16</b> MARTEDÌ s. Marcello	

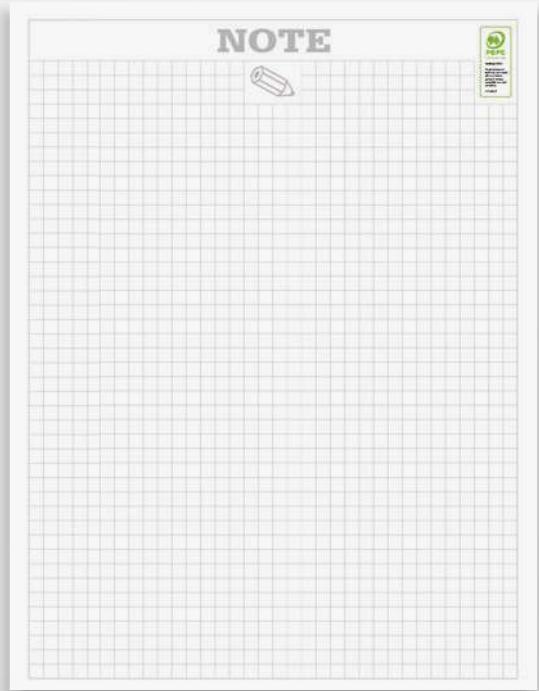

Retrostampato con pagina note

PLANNING 2025											
Gennaio				Febbraio				Marzo			
Aprile				Maggio				Giugno			
Luglio				Agosto				Settembre			
Ottobre				Novembre				Dicembre			
Note											

Planning 2025 in ultima pagina

formato 29x47 cm ca

Festività Internazionali

### PA600 Multicolor

Olandese 12 fogli carta patinata 70 gr, testata termosaldada pagina note stampata sul retro, planning 2025 in ultima pagina



- f.to calendario: 29x47 cm ca
- f.to testata: 29x9 cm ca
- 100



Testata Termosaldata

GENNAIO 2024

DICEMBRE 2023				FEBBRAIO 2024
1 V	<b>1</b> LUNEDI	17 MERCOLEDI		1 G
2 S	<b>2</b> MARTEDI	18 GIOVEDI		2 V
3 D	<b>3</b> MERCOLEDI	19 VENERDI		3 S
4 L	<b>4</b> GIOVEDI	20 SABATO		4 D
5 M	<b>5</b> VENERDI	21 DOMENICA		5 L
6 M	<b>6</b> SABATO	22 LUNEDI		6 M
7 G	<b>7</b> DOMENICA	23 MARTEDI		7 M
8 V	<b>8</b> LUNEDI	24 MERCOLEDI		8 G
9 S	<b>9</b> MARTEDI	25 GIOVEDI		9 V
10 D	<b>10</b> MERCOLEDI	26 VENERDI		10 S
11 L	<b>11</b> GIOVEDI	27 SABATO		11 D
12 M	<b>12</b> VENERDI	28 DOMENICA		12 L
13 M	<b>13</b> SABATO	29 LUNEDI		13 M
14 G	<b>14</b> DOMENICA	30 MARTEDI		14 M
15 V	<b>15</b> LUNEDI	31 MERCOLEDI		15 G
16 S	<b>16</b> MARTEDI			16 V

**IL SOLE** Sorge Tramonta **LA LUNA** ☾ ☽

Gennaio 1 ore 7.37 ore 16.49 ☾ U.Q. Gennaio 4 ore 4.30

Gennaio 10 ore 7.37 ore 16.57 ☽ L.N. Gennaio 11 ore 12.53

Gennaio 20 ore 7.33 ore 17.09 ☽ P.Q. Gennaio 18 ore 4.52

Note: la luna è il simbolo di ogni mese nel calendario e riflettuto sempre al suo valore.

## NOTE

Retrostampato con pagina note



formato  
29x47 cm ca

Festività  
Internazionali

**PA610** Quadrettato

Olandese 12 fogli carta patinata 70 gr, testata termosaldada pagina note stampata sul retro

- f.to calendario: 29x47 cm ca
- f.to testata: 29x9 cm ca
- 100

Con l'approvvigionamento di materiale PEFC, stiamo supportando le foreste gestite in modo sostenibile a livello globale  
www.pefc.it

NEW!

Testata  
Termosaldata

**GENNAIO**

1	LUN	1	17	MER	17.349
2	MAR	2.354	18	GIO	18.348
3	MER	3.363	19	VEN	19.347
4	GIO	4.362	20	SAB	20.346
5	VEN	5.361	21	DOM	21.345
6	SAB	6.360	22	LUN	22.344
7	DOM	7.359	23	MAR	23.343
8	LUN	8.358	24	MER	24.342
9	MAR	9.357	25	GIO	25.341
10	MER	10.356	26	VEN	26.340
11	GIO	11.355	27	SAB	27.339
12	VEN	12.354	28	DOM	28.338
13	SAB	13.353	29	LUN	29.337
14	DOM	14.352	30	MAR	30.336
15	LUN	15.351	31	MER	31.335
16	MAR	16.350			

**Capricorno** 22/12 - 20/1

**Acquario** 21/1 - 19/2

**FEBBRAIO 2024**

L	M	M	G	V	S	D
	1	2	3	4		
5	6	7	8	9	10	11
12	13	14	15	16	17	18
19	20	21	22	23	24	25
26	27	28	29			

**IL SOLE** Sorge: 6.50, tramonta: 16.47  
 Luna: 1. 2.30, 2. 2.30, 3. 2.30, 4. 2.30  
 Luna: 1. 17.00, 2. 17.00, 3. 17.00, 4. 17.00

**LA LUNA** Luna: 1. 18.47, 2. 18.47, 3. 18.47, 4. 18.47  
 Luna: 1. 18.47, 2. 18.47, 3. 18.47, 4. 18.47

Retrostampato  
con pagina  
noteformato  
29x47 cm caFestività  
Internazionali**PA611 Danish**Olandese 12 fogli carta patinata 70 gr, testata termosaldata  
pagina note stampata sul retro

- f.to calendario: 29x47 cm ca
- f.to testata: 29x9 cm ca
- 100





Testata Termosaldata

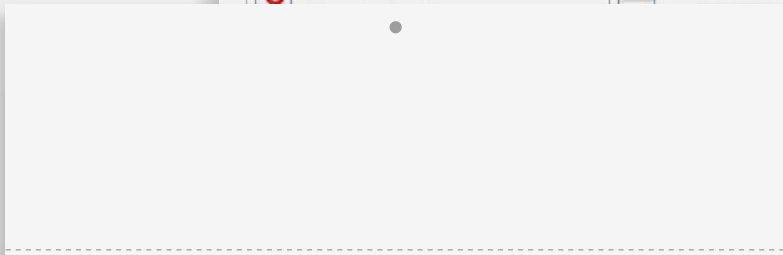

<b>1 LUN</b> S. ANTONIO ABATE 07:349	<b>17 MER</b> S. ANTONIO ABATE 07:349	<b>DICEMBRE 2023</b> L M M G V S D 1 2 3 4 5 6 7 8 9 10 11 12 13 14 15 16 17 18 19 20 21 22 23 24 25 26 27 28 29 30 31	
<b>2 MAR</b> S. BASILIO E GREGORIO 08:348	<b>18 GIO</b> S. LIBERATA 08:348	<b>GENNAIO</b> 20 24	
<b>3 MER</b> S. GENOVEFFA 08:347	<b>19 VEN</b> S. MAURO 08:347	<b>FEBBRAIO 2024</b> L M M G V S D 1 2 3 4 5 6 7 8 9 10 11 12 13 14 15 16 17 18 19 20 21 22 23 24 25 26 27 28 29	
<b>4 GIO</b> S. ERNESTE E CILIO 09:342	<b>20 SAB</b> S. SEBASTIANO E FABIANO 09:346		
<b>5 VEN</b> S. ANIELLA 09:345	<b>21 DOM</b> S. ADRIANO 09:345		
<b>6 SAB</b> S. SPIRITO DI N.S. 09:340	<b>22 LUN</b> S. VINCENZO 09:344		
<b>7 DOM</b> Battesimo di Gesù 09:339	<b>23 MAR</b> S. EMERENTIANA 09:343		
<b>8 LUN</b> S. MASSIMO 09:338	<b>24 MER</b> S. FRANCESCO DI SALES 09:342		
<b>9 MAR</b> S. GIULIANO 09:337	<b>25 GIO</b> CONVERSIONE DI S. PAOLO 09:340		
<b>10 MER</b> S. ALDO 09:336	<b>26 VEN</b> S. TITO E TIMOTEO 09:340		
<b>11 GIO</b> S. SEBASTIANO 09:335	<b>27 SAB</b> S. ANGELA MERICI 09:338		
<b>12 VEN</b> S. CESARIA 09:334	<b>28 DOM</b> S. TOMMASO D'ACQUINO 09:338		
<b>13 SAB</b> S. ALDO 09:333	<b>29 LUN</b> S. COSTANZO 09:337		
<b>14 DOM</b> S. FELICE 09:332	<b>30 MAR</b> S. MARTINA 09:336		
<b>15 LUN</b> S. MAURO 09:331	<b>31 MER</b> S. GIOVANNI BOSCO 09:335		
<b>16 MAR</b> S. MARCELLO 09:330			

Retrostampato con pagina appunti



formato 29x47 cm ca

Festività Internazionali

PA614 Swedish

Olandese 12 fogli carta patinata 70 gr, testata termosaldata pagina appunti stampata sul retro

- f.to calendario: 29x47 cm ca
- f.to testata: 29x9 cm ca
- 100



Testata Termosaldata

1 **L** <sup>00000000</sup> 01  
s. Maria Maddalena di Dio - Capodanno

2 **M**  
ss. Basilio e Gregorio

3 **M**  
s. Giovanna

4 **G**  
ss. Ermete e Cato

5 **V**  
s. Arnolfo

6 **S** <sup>0000</sup>  
Epifania di N.S.

7 **D**  
Battesimo di Gesù

8 **L** 02  
s. Massimo

9 **M**  
s. Giuliano

10 **M**  
s. Aldo

11 **G**  
s. Iginio

12 **V**  
s. Costia

13 **S**  
s. Felice

14 **D**  
s. Felice

15 **L** 03  
s. Mauro

16 **M**  
s. Marcello

17 **M**  
s. Antonio abate

18 **G**  
s. Liberata

19 **V**  
s. Mario

20 **S**  
ss. Sebastiano e Fabiano

21 **D**  
s. Agnese

22 **L** 04  
s. Vincenzo

23 **M**  
s. Eusebio

24 **M**  
s. Francesco di Sales

25 **G**  
Conversione di s. Paolo

26 **V**  
ss. Tito e Timoteo

27 **S**  
s. Angela Merici

28 **D**  
s. Tommaso d'Aquino

29 **L** 05  
s. Costantino

30 **M**  
s. Martina

31 **M**  
s. Giovanni Bosco

**2024**

**DICEMBRE 2023**  
L M M G V S D  
1 2 3  
4 5 6 7 8 9 10  
11 12 13 14 15 16 17  
18 19 20 21 22 23 24  
25 26 27 28 29 30 31

**FEBBRAIO 2024**  
L M M G V S D  
1 2 3 4  
5 6 7 8 9 10 11  
12 13 14 15 16 17 18  
19 20 21 22 23 24 25  
26 27 28 29

**IL SOLE**  
sorge tramonta  
giorno 1 ore 7:37 ore 16:49  
giorno 30 ore 7:37 ore 16:57  
giorno 31 ore 7:37 ore 17:09  
Note: gli orari di tramonto del giorno 31/12/23  
e di tramonto di Capodanno 01/01/24.

**LA LUNA**  
● primo quarto giorno 4 ore 4:50  
● luna nuova giorno 11 ore 12:57  
● primo quarto giorno 18 ore 4:52  
● luna piena giorno 25 ore 18:54

**gen  
io  
na**

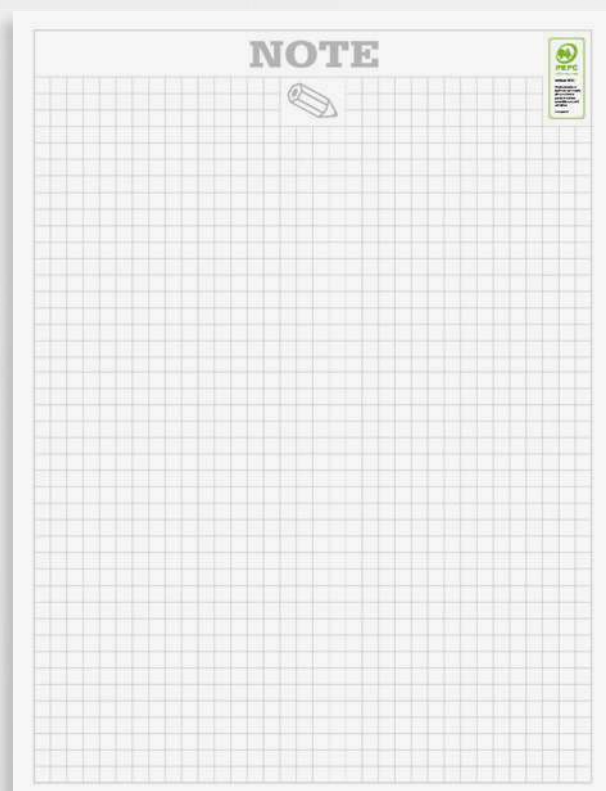

Retrostampato con pagina note

formato  
29x47 cm ca

Festività  
Internazionali

**PA615 Moderno**

Olandese 12 fogli carta patinata 70 gr, testata termosaldata  
pagina note stampata sul retro



☑ f.to calendario: 29x47 cm ca

☑ f.to testata: 29x9 cm ca

☑ 100



Testata Termosaldata

**NOTE**

**GENNAIO 2024**

**1** lun **17** mer

**2** mar **18** gio

**3** mer **19** ven

**4** gio **20** sab

**5** ven **21** dom

**6** sab **22** lun

**7** dom **23** mar

**8** lun **24** mer

**9** mar **25** gio

**10** mer **26** ven

**11** gio **27** sab

**12** ven **28** dom

**13** sab **29** lun

**14** dom **30** mar

**15** lun **31** mer

**16** mar

**LA LUNA**

**IL SOLE**

**NOTE**

**GENNAIO 2024**

**1** lun **17** mer

**2** mar **18** gio

**3** mer **19** ven

**4** gio **20** sab

**5** ven **21** dom

**6** sab **22** lun

**7** dom **23** mar

**8** lun **24** mer

**9** mar **25** gio

**10** mer **26** ven

**11** gio **27** sab

**12** ven **28** dom

**13** sab **29** lun

**14** dom **30** mar

**15** lun **31** mer

**16** mar

RO

**NOTE**

**GENNAIO 2024**

**1** lun **17** mer

**2** mar **18** gio

**3** mer **19** ven

**4** gio **20** sab

**5** ven **21** dom

**6** sab **22** lun

**7** dom **23** mar

**8** lun **24** mer

**9** mar **25** gio

**10** mer **26** ven

**11** gio **27** sab

**12** ven **28** dom

**13** sab **29** lun

**14** dom **30** mar

**15** lun **31** mer

**16** mar

Retrostampato con pagina note

AZ

formato 29x47 cm ca

Festività Internazionali

VE

**PA620 Smart**

Olandese 12 fogli carta patinata 70 gr, testata termosalddata pagina note stampata sul retro

- ☑ f.to calendario: 29x47 cm ca
- ☑ f.to testata: 29x9 cm ca
- ☑ 100



NEW!

Testata Termosaldata

**GENNAIO 2024**

<b>1 LUN</b> Maria Madre di Dio - Capodomo	<b>17 MER</b> s. Antonio abate
<b>2 MAR</b> ss. Basilio e Gregorio	<b>18 GIO</b> s. Liberta
<b>3 MER</b> s. Gervasio	<b>19 VEN</b> s. Mario
<b>4 GIO</b> ss. Erasmo e Cato	<b>20 SAB</b> ss. Sebastiano e Fabiano
<b>5 VEN</b> s. Anna	<b>21 DOM</b> s. Agnese
<b>6 SAB</b> Epifania di N.S.	<b>22 LUN</b> s. Vincenzo
<b>7 DOM</b> Battesimo di Gesù	<b>23 MAR</b> s. Emerenziana
<b>8 LUN</b> s. Massimo	<b>24 MER</b> s. Francesco di Sales
<b>9 MAR</b> s. Giuliano	<b>25 GIO</b> Conversione di s. Paolo
<b>10 MER</b> s. Aido	<b>26 VEN</b> ss. Tito e Timoteo
<b>11 GIO</b> s. Iorio	<b>27 SAB</b> s. Angela Merici
<b>12 VEN</b> s. Clelia	<b>28 DOM</b> s. Tommaso d'Aquino
<b>13 SAB</b> s. Ilario	<b>29 LUN</b> s. Costanzo
<b>14 DOM</b> s. Felice	<b>30 MAR</b> s. Martina
<b>15 LUN</b> s. Mauro	<b>31 MER</b> s. Giovanni Bosco

formato 29x47 cm ca

Festività Internazionali

Retrostampato con pagina note

RO

**GENNAIO 2024**

BL

VE

PA636 Notes

Olandese 12 fogli carta patinata 70 gr, testata termosaldada pagina note stampata sul retro



- f.to calendario: 29x47 cm ca
- f.to testata: 29x9 cm ca
- 100



Testata Termosaldata



GENNAIO 2024		
DIC 2023	1 ven	2 sab
	3 dom	4 lun
	5 mar	6 mer
	7 gio	8 ven
	9 sab	10 dom
	11 lun	12 mar
	13 mer	14 gio
	15 ven	16 sab
	17 dom	18 lun
	19 mar	20 mer
	21 gio	22 ven
	23 sab	24 dom
	25 lun	26 mar
	27 mer	28 gio
	29 ven	30 sab
	31 dom	
	17 mercoledì	18 giovedì
	19 venerdì	20 sabato
	21 domenica	22 lunedì
	23 martedì	24 mercoledì
	25 giovedì	26 venerdì
	27 sabato	28 domenica
	29 lunedì	30 martedì
	31 mercoledì	



RO



Retrostampato con pagina note

BL

VE

formato 29x47 cm ca

Festività Internazionali

PA640 Classic

Olandese 12 fogli carta patinata 70 gr, testata termosalddata pagina note stampata sul retro



- f.to calendario: 29x47 cm ca
- f.to testata: 29x9 cm ca
- 100



Testata Termosaldata



GENNAIO 2024		
<b>1</b> VENERDÌ s. Maria Maddalena - Capodanno	<b>17</b> MERCOLEDÌ s. Antonio abate	<b>1</b> GIOVEDÌ s. Basilio
<b>2</b> MARTEDÌ ss. Basilio e Gregorio	<b>18</b> GIOVEDÌ s. Liberata	<b>2</b> VENERDÌ s. Stefano
<b>3</b> MERCOLEDÌ s. Genoveffa	<b>19</b> VENERDÌ s. Mario	<b>3</b> SABATO s. Agostino
<b>4</b> GIOVEDÌ ss. Ermes e Caio	<b>20</b> SABATO ss. Giovanni e Felice	<b>4</b> DOMENICA s. Ignazio
<b>5</b> VENERDÌ s. Amelia	<b>21</b> DOMENICA s. Agostino	<b>5</b> LUNEDÌ s. Ignazio
<b>6</b> SABATO Epifania di N.S.	<b>22</b> LUNEDÌ s. Vincenzo	<b>6</b> MARTEDÌ s. Stefano
<b>7</b> DOMENICA Battesimo di Gesù	<b>23</b> MARTEDÌ s. Eusebio	<b>7</b> MERCOLEDÌ s. Stefano
<b>8</b> LUNEDÌ s. Massimo	<b>24</b> MERCOLEDÌ s. Francesco di Sales	<b>8</b> GIOVEDÌ s. Stefano
<b>9</b> MARTEDÌ s. Giuliano	<b>25</b> GIOVEDÌ Conversione di s. Paolo	<b>9</b> VENERDÌ s. Stefano
<b>10</b> MERCOLEDÌ s. Aldo	<b>26</b> VENERDÌ ss. Tito e Timoteo	<b>10</b> SABATO s. Stefano
<b>11</b> GIOVEDÌ s. Ignazio	<b>27</b> SABATO s. Angela Merici	<b>11</b> DOMENICA s. Stefano
<b>12</b> VENERDÌ s. Cesira	<b>28</b> DOMENICA s. Tommaso d'Aquino	<b>12</b> LUNEDÌ s. Stefano
<b>13</b> SABATO s. Ilario	<b>29</b> LUNEDÌ s. Costantino	<b>13</b> MARTEDÌ s. Stefano
<b>14</b> DOMENICA s. Felice	<b>30</b> MARTEDÌ s. Martina	<b>14</b> MERCOLEDÌ s. Stefano
<b>15</b> LUNEDÌ s. Mauro	<b>31</b> MERCOLEDÌ s. Giovanni Bosco	<b>15</b> GIOVEDÌ s. Stefano
<b>16</b> MARTEDÌ s. Marcello		<b>16</b> VENERDÌ s. Stefano

GENNAIO 2024		
<b>1</b> VENERDÌ s. Maria Maddalena - Capodanno	<b>17</b> MERCOLEDÌ s. Antonio abate	<b>1</b> GIOVEDÌ s. Basilio
<b>2</b> MARTEDÌ ss. Basilio e Gregorio	<b>18</b> GIOVEDÌ s. Liberata	<b>2</b> VENERDÌ s. Stefano
<b>3</b> MERCOLEDÌ s. Genoveffa	<b>19</b> VENERDÌ s. Mario	<b>3</b> SABATO s. Agostino
<b>4</b> GIOVEDÌ ss. Ermes e Caio	<b>20</b> SABATO ss. Giovanni e Felice	<b>4</b> DOMENICA s. Ignazio
<b>5</b> VENERDÌ s. Amelia	<b>21</b> DOMENICA s. Agostino	<b>5</b> LUNEDÌ s. Ignazio
<b>6</b> SABATO Epifania di N.S.	<b>22</b> LUNEDÌ s. Vincenzo	<b>6</b> MARTEDÌ s. Stefano
<b>7</b> DOMENICA Battesimo di Gesù	<b>23</b> MARTEDÌ s. Eusebio	<b>7</b> MERCOLEDÌ s. Stefano
<b>8</b> LUNEDÌ s. Massimo	<b>24</b> MERCOLEDÌ s. Francesco di Sales	<b>8</b> GIOVEDÌ s. Stefano
<b>9</b> MARTEDÌ s. Giuliano	<b>25</b> GIOVEDÌ Conversione di s. Paolo	<b>9</b> VENERDÌ s. Stefano
<b>10</b> MERCOLEDÌ s. Aldo	<b>26</b> VENERDÌ ss. Tito e Timoteo	<b>10</b> SABATO s. Stefano
<b>11</b> GIOVEDÌ s. Ignazio	<b>27</b> SABATO s. Angela Merici	<b>11</b> DOMENICA s. Stefano
<b>12</b> VENERDÌ s. Cesira	<b>28</b> DOMENICA s. Tommaso d'Aquino	<b>12</b> LUNEDÌ s. Stefano
<b>13</b> SABATO s. Ilario	<b>29</b> LUNEDÌ s. Costantino	<b>13</b> MARTEDÌ s. Stefano
<b>14</b> DOMENICA s. Felice	<b>30</b> MARTEDÌ s. Martina	<b>14</b> MERCOLEDÌ s. Stefano
<b>15</b> LUNEDÌ s. Mauro	<b>31</b> MERCOLEDÌ s. Giovanni Bosco	<b>15</b> GIOVEDÌ s. Stefano
<b>16</b> MARTEDÌ s. Marcello		<b>16</b> VENERDÌ s. Stefano

BL

Retrostampato con pagina note

VE

GENNAIO 2024		
<b>1</b> VENERDÌ s. Maria Maddalena - Capodanno	<b>17</b> MERCOLEDÌ s. Antonio abate	<b>1</b> GIOVEDÌ s. Basilio
<b>2</b> MARTEDÌ ss. Basilio e Gregorio	<b>18</b> GIOVEDÌ s. Liberata	<b>2</b> VENERDÌ s. Stefano
<b>3</b> MERCOLEDÌ s. Genoveffa	<b>19</b> VENERDÌ s. Mario	<b>3</b> SABATO s. Agostino
<b>4</b> GIOVEDÌ ss. Ermes e Caio	<b>20</b> SABATO ss. Giovanni e Felice	<b>4</b> DOMENICA s. Ignazio
<b>5</b> VENERDÌ s. Amelia	<b>21</b> DOMENICA s. Agostino	<b>5</b> LUNEDÌ s. Ignazio
<b>6</b> SABATO Epifania di N.S.	<b>22</b> LUNEDÌ s. Vincenzo	<b>6</b> MARTEDÌ s. Stefano
<b>7</b> DOMENICA Battesimo di Gesù	<b>23</b> MARTEDÌ s. Eusebio	<b>7</b> MERCOLEDÌ s. Stefano
<b>8</b> LUNEDÌ s. Massimo	<b>24</b> MERCOLEDÌ s. Francesco di Sales	<b>8</b> GIOVEDÌ s. Stefano
<b>9</b> MARTEDÌ s. Giuliano	<b>25</b> GIOVEDÌ Conversione di s. Paolo	<b>9</b> VENERDÌ s. Stefano
<b>10</b> MERCOLEDÌ s. Aldo	<b>26</b> VENERDÌ ss. Tito e Timoteo	<b>10</b> SABATO s. Stefano
<b>11</b> GIOVEDÌ s. Ignazio	<b>27</b> SABATO s. Angela Merici	<b>11</b> DOMENICA s. Stefano
<b>12</b> VENERDÌ s. Cesira	<b>28</b> DOMENICA s. Tommaso d'Aquino	<b>12</b> LUNEDÌ s. Stefano
<b>13</b> SABATO s. Ilario	<b>29</b> LUNEDÌ s. Costantino	<b>13</b> MARTEDÌ s. Stefano
<b>14</b> DOMENICA s. Felice	<b>30</b> MARTEDÌ s. Martina	<b>14</b> MERCOLEDÌ s. Stefano
<b>15</b> LUNEDÌ s. Mauro	<b>31</b> MERCOLEDÌ s. Giovanni Bosco	<b>15</b> GIOVEDÌ s. Stefano
<b>16</b> MARTEDÌ s. Marcello		<b>16</b> VENERDÌ s. Stefano

RO

formato 29x47 cm ca

Festività Internazionali

PA646 Elegant

Olandese 12 fogli carta patinata 70 gr, testata termosaldada pagina note stampata sul retro



- f.to calendario: 29x47 cm ca
- f.to testata: 29x9 cm ca
- 100



Testata Termosaldata



Retrostampato con pagina appunti

BL



RO

VE

formato 29x42,5 cm ca

Festività Internazionali

PA650 Medium

Olandese 12 fogli carta patinata 70 gr, testata termosalddata pagina appunti stampata sul retro



- f.to calendario: 29x42,5 cm ca
- f.to testata: 29x9 cm ca
- 100



NEW!

Testata Termosaldata

**1 L** 01 **20 S**  
 Maria Madre di Dio - Capodanno ss. Sebastiano e Fabiano

**2 M** 02 **21 D**  
 ss. Basilio e Gregorio s. Agnese

**3 M** 03 **22 L**  
 s. Gionocetta s. Vincenzo

**4 G** 04 **23 M**  
 ss. Ermete e Caio s. Eusebio

**5 V** 05 **24 M**  
 s. Arnolfo s. Francesco di Sales

**6 S** 06 **25 G**  
 Epifania di N.S. Conversione di s. Paolo

**7 D** 07 **26 V**  
 Battesimo di Gesù ss. Tito e Timoteo

**8 L** 08 **27 S**  
 s. Massimo s. Angela Merici

**9 M** 09 **28 D**  
 s. Giuliano s. Tommaso d'Aquino

**10 M** 10 **29 L**  
 s. Aldo s. Costantino

**11 G** 11 **30 M**  
 s. Igino s. Martina

**12 V** 12 **31 M**  
 s. Coste s. Giovanni Bosco

**13 S** 13  
 s. Ilario

**14 D** 14  
 s. Felice

**15 L** 15  
 s. Misao

**16 M** 16  
 s. Marcellino

**17 M** 17  
 s. Antonio abate

**18 G** 18  
 s. Liberata

**19 V** 19  
 s. Maria

**gen  
na  
io**

**DICEMBRE 2023**  
 Set. 48 49 50 51 52  
 Lun 4 -1 18 25  
 Mar 5 12 19 26  
 Mer 6 13 20 27  
 Gio 7 14 21 28  
 Ven 1 8 15 22 29  
 Sab 2 9 16 23 30  
 Dom 3 10 17 24 31

**FEBBRAIO 2024**  
 Set. 5 6 7 8 9  
 Lun 5 12 19 26  
 Mar 6 13 20 27  
 Mer 7 14 21 28  
 Gio 1 8 15 22 29  
 Ven 2 9 16 23  
 Sab 3 10 17 24  
 Dom 4 11 18 25

**Il Sole e la Luna**  
 sorge tramonta  
 giorno 1 ore 7:37 ore 16:49  
 giorno 10 ore 7:37 ore 16:57  
 giorno 20 ore 7:32 ore 17:02

**NOTE**

**2024**

**CAPRICORNO**  
 22/12 - 20/1

Retrostampato con pagina note

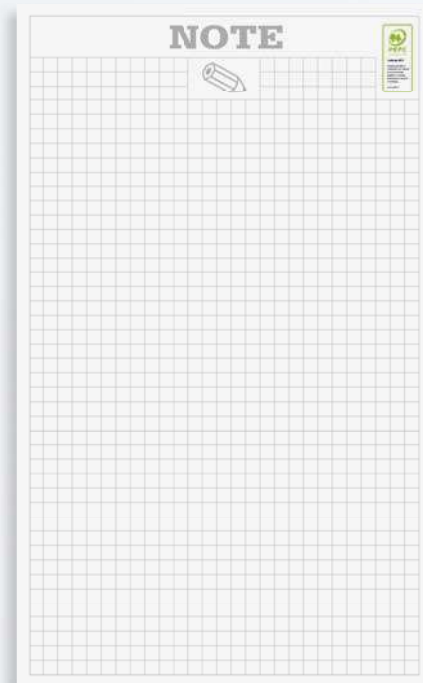

Planning 2025 in ultima pagina

**planning 2025**

**Gennaio** **Febbraio** **Marzo**

**Aprile** **Maggio** **Giugno**

**Luglio** **Agosto** **Settembre**

**Ottobre** **Novembre** **Dicembre**

**note**

formato  
23x47 cm ca



Festività  
Internazionali

### PA654 Shaded Moderno

Olandese 12 fogli carta patinata 70 gr, testata termosaldata  
 pagina note stampata sul retro, planning 2025 in ultima pagina



f.to calendario: 23x47 cm ca

f.to testata: 23x9 cm ca

100





Testata Termosaldata

Retrostampato con pagina note

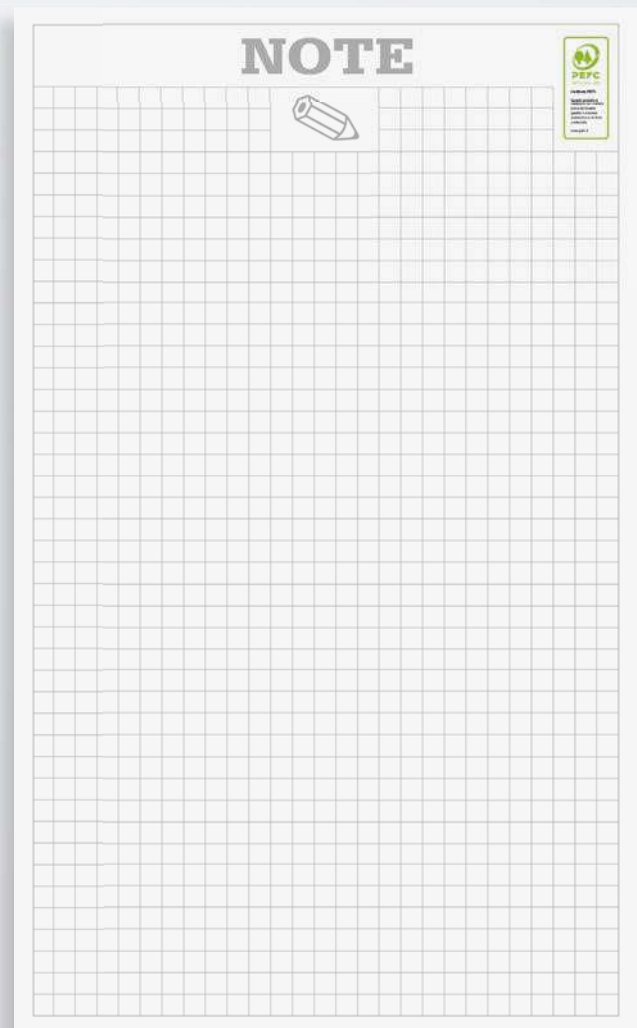

formato 23x47 cm ca

Festività Internazionali

**PA658 Shaded Color**

Olandese 12 fogli carta patinata 70 gr, testata termosaldada pagina note stampata sul retro



- f.to calendario: 23x47 cm ca
- f.to testata: 23x9 cm ca
- 100



## PA670

Testata  
Termosaldata

NOTE

Retrostampato  
con pagina noteformato  
14x47 cm caFestività  
Internazionali

## PA670 Multicolor Silhouette

Silhouette 12 fogli, carta patinata 70 gr  
testata termosaldata  
pagina note stampata sul retro

- f.to calendario: 14x47 cm ca
- f.to testata: 14x9 cm ca
- 100

## PA677

Testata  
Termosaldata

NEW!

**NUOVO  
FORMATO**  
7x47 cm ca
Festività  
Internazionali

## PA677 Multicolor Slim

Silhouette 12 fogli, carta patinata 70 gr  
testata termosaldata

- f.to calendario: 7x47 cm ca
- f.to testata: 7x9 cm ca
- 200

**PA673**

Testata Termosaldata

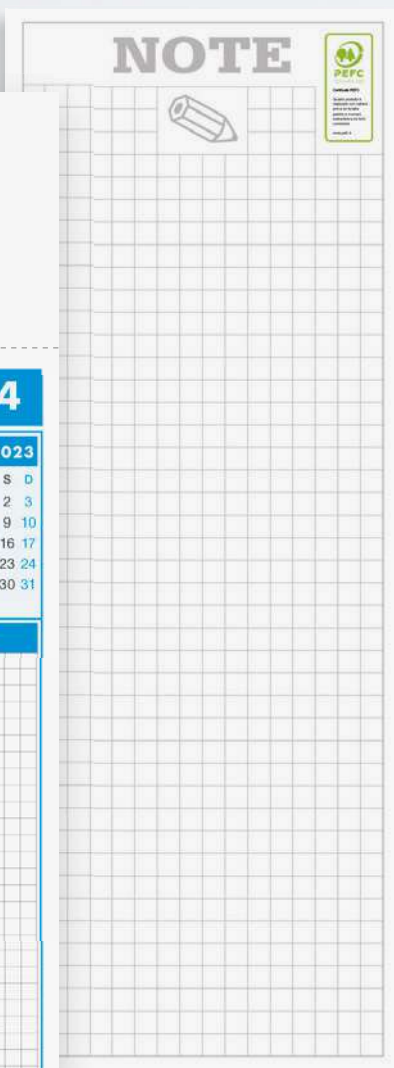

**PA675**

Testata Termosaldata



**NUOVO FORMATO**  
7x47 cm ca



Retrostampato con pagina note



formato 14x47 cm ca

Festività Internazionali

Festività Internazionali

**PA673 Silhouette Notes**

Silhouette 12 fogli, carta patinata 70 gr testata termosaldada pagina note stampata sul retro



- f.to calendario: 14x47 cm ca
- f.to testata: 14x9 cm ca
- 100

**PA675 Block Slim**

Silhouette 12 fogli, carta patinata 70 gr testata termosaldada



- f.to calendario: 7x47 cm ca
- f.to testata: 7x9 cm ca
- 200



NEW!

testata  
magneticapenna  
inclusa

### PA785 Magnetic

Calendario mini con calamita sul retro della testata per attaccarlo sul frigorifero, 12 fogli illustrato paesaggi carta 70 gr, supporto e testata in cartoncino, elastico portapenna, penna inclusa



f.to calendario: 9x23,7 cm ca

f.to testata: 9x3,7 cm ca

10/100

02

# Calendari da tavolo



formato  
19x14,5 cm ca

NEW!

Festività  
Internazionali



Tabella 2025  
in ultima  
pagina



### PA703 Block Table

Spiralato da tavolo mensile 13 fogli  
carta bianca 90 gr, supporto cartoncino bianco 450 gr



f.to calendario: 19x14,5 cm ca

f.to piedino: 19x3,5 cm ca

100



La carta proviene da  
materiale certificato FSC®,  
materiale riciclato e/o legno  
controllato.

formato  
19x14,5 cm ca

Festività  
Internazionali



Tabella 2025  
in ultima  
pagina



**PA705 Color Mix**

Spiralato da tavolo mensile 13 fogli  
carta bianca 90 gr, supporto cartoncino bianco 450 gr



- f.to calendario: 19x14,5 cm ca
- f.to piedino: 19x3,5 cm ca
- 100



La carta proviene da  
materiale certificato FSC®,  
materiale riciclato e/o legno  
controllato.

formato  
16x14,5 cm ca

Festività  
Internazionali

BL



Tabella 2025  
in ultima  
pagina



**PA700** Midi table

Spiralato da tavolo mensile 13 fogli  
carta bianca 90 gr, supporto cartoncino bianco 450 gr



- ☑ f.to calendario: 16x14,5 cm ca
- ☑ f.to piedino: 16x3,5 cm ca
- ☑ 100



La carta proviene da  
materiale certificato FSC®,  
materiale riciclato e/o legno  
controllato.





formato  
19x14,5 cm ca

Festività  
Internazionali

VE



Tabella 2025  
in ultima  
pagina



## PA710 Table notes

Spiralato da tavolo mensile 13 fogli  
carta bianca 90 gr, supporto cartoncino bianco 450 gr



f.to calendario: 19x14,5 cm ca

f.to piedino: 19x3,5 cm ca

100



La carta proviene da  
materiale certificato FSC®,  
materiale riciclato e/o legno  
controllato.



formato  
19x14,5 cm ca

Festività  
Internazionali

RO



Tabella 2025  
in ultima  
pagina



**PA715 Chart table**

Spiralato da tavolo mensile 13 fogli  
carta bianca 90 gr, supporto cartoncino bianco 450 gr



- f.to calendario: 19x14,5 cm ca
- f.to piedino: 19x3,5 cm ca
- 100



La carta proviene da  
materiale certificato FSC®,  
materiale riciclato e/o legno  
controllato.



BL

formato 19x14,5 cm ca

Festività Internazionali

Tabella 2025 in ultima pagina



VE

formato 19x14,5 cm ca

Festività Internazionali

Tabella 2025 in ultima pagina

formato  
19x14,5 cm ca

Festività  
Internazionali



Tabella 2025  
in ultima  
pagina



Tabella 2024  
sul retro

### PA720 Mod table

Spiralato da tavolo mensile 13 fogli  
carta bianca 90 gr, supporto cartoncino bianco 450 gr



f.to calendario: 19x14,5 cm ca

f.to piedino: 19x3,5 cm ca

100



La carta proviene da  
materiale certificato FSC®,  
materiale riciclato e/o legno  
controllato.

formato  
19x14,5 cm ca

Festività  
Internazionali



Tabella 2025  
in ultima  
pagina



**PA725 Swedish Table**

Spiralato da tavolo mensile 13 fogli  
carta bianca 90 gr, supporto cartoncino bianco 450 gr



- f.to calendario: 19x14,5 cm ca
- f.to piedino: 19x3,5 cm ca
- 100



La carta proviene da  
materiale certificato FSC®,  
materiale riciclato e/o legno  
controllato.

formato  
19x14,5 cm ca

Festività  
Internazionali



Tabella 2025  
in ultima  
pagina



### PA730 Square table

Spiralato da tavolo mensile 13 fogli  
carta bianca 90 gr, supporto cartoncino bianco 450 gr



☑ f.to calendario: 19x14,5 cm ca

☑ f.to piedino: 19x3,5 cm ca

☑ 100



La carta proviene da  
materiale certificato FSC®,  
materiale riciclato e/o legno  
controllato.





formato  
19x14,5 cm ca



La carta proviene da materiale certificato FSC®, materiale riciclato e/o legno controllato.

Festività Internazionali



Tabella 2025  
in ultima  
pagina

**PA740 4 seasons table**

Spiralato da tavolo mensile 13 fogli  
carta bianca 90 gr, supporto cartoncino bianco 450 gr



- f.to calendario: 19x14,5 cm ca
- f.to piedino: 19x3,5 cm ca
- 100



La carta proviene da  
da materiale certificato FSC®,  
materiale riciclato e/o  
legno controllato.

formato  
13,5x19 cm ca



Festività  
Internazionali



DICEMBRE - DECEMBER 2023							
SETTIMANA WEEK	LUNEDÌ MONDAY	MARTEDÌ TUESDAY	MERCOLEDÌ WEDNESDAY	GIOVEDÌ THURSDAY	VENERDÌ FRIDAY	SABATO SATURDAY	DOMENICA SUNDAY
48							
49	4	5	6	7	1	2	3
50	11	12	13	14	8	9	10
51	18	19	20	21	15	16	17
52	25	26	27	28	22	23	24
					29	30	31

GENNAIO - JANUARY 2024							
SETTIMANA WEEK	LUNEDÌ MONDAY	MARTEDÌ TUESDAY	MERCOLEDÌ WEDNESDAY	GIOVEDÌ THURSDAY	VENERDÌ FRIDAY	SABATO SATURDAY	DOMENICA SUNDAY
01	1	2	3	4	5	6	7
02	8	9	10	11	12	13	14
03	15	16	17	18	19	20	21
04	22	23	24	25	26	27	28
05	29	30	31				

FEBRUARY 2024			
GIOVEDÌ THURSDAY	VENERDÌ FRIDAY	SABATO SATURDAY	DOMENICA SUNDAY
1	2	3	4
8	9	10	11
15	16	17	18
22	23	24	25

Gennaio - January 2024		
1 Lun	01	17 Mer
2 Mar	02	18 Gio
3 Mer	03	19 Ven
4 Gio	04	20 Sab
5 Ven	05	21 Dom
6 Sab	06	22 Lun
7 Dom	07	23 Mar
8 Lun	08	24 Mer
9 Mar	09	25 Gio
10 Mer	10	26 Ven
11 Gio	11	27 Sab
12 Ven	12	28 Dom
13 Sab	13	29 Lun
14 Dom	14	30 Mar
15 Lun	15	31 Mer
16 Mar	16	



## PA745 Tall table

Spiralato da tavolo mensile 13 fogli  
carta bianca 90 gr, supporto cartoncino bianco 450 gr



f.to calendario: 13,5x19 cm ca

f.to piedino: 13,5x3,5 cm ca

100

Tabella 2025  
in ultima pagina

formato 23x18 cm ca Festività Internazionali

Ampia fascia personalizzabile anche con stampa UV



BL



GR



VE



RO

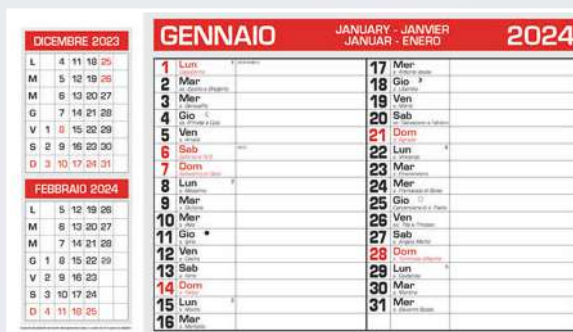

Calendario con mensili laterali



PA782 Calendar pad



Tappetino mouse calendario, 12 mesi con note copertina rigida in pvc, base in eva

- f.to calendario: 23x18 cm ca
- 200

Tappetino pad con **Calendario 12 mesi**



NEW!

formato  
25x14,5 cm ca



Pagina note  
per appunti

AZ

## PA750 Calendo planning

Spiralato da tavolo settimanale 56 pagine  
carta bianca 70 gr, supporto cartoncino bianco 450 gr



f.to calendario: 25x14,5 cm ca

f.to piedino: 25x3,5 cm ca

100



La carta proviene da  
materiale certificato FSC®,  
materiale riciclato e/o legno  
controllato.

formato 25x14,5 cm ca



Pagina note per appunti

RO

formato 25x14,5 cm ca



Pagina note per appunti

VE

# PA012 Antiche mappe

formato  
31x52,5 cm ca

Festività  
Internazionali

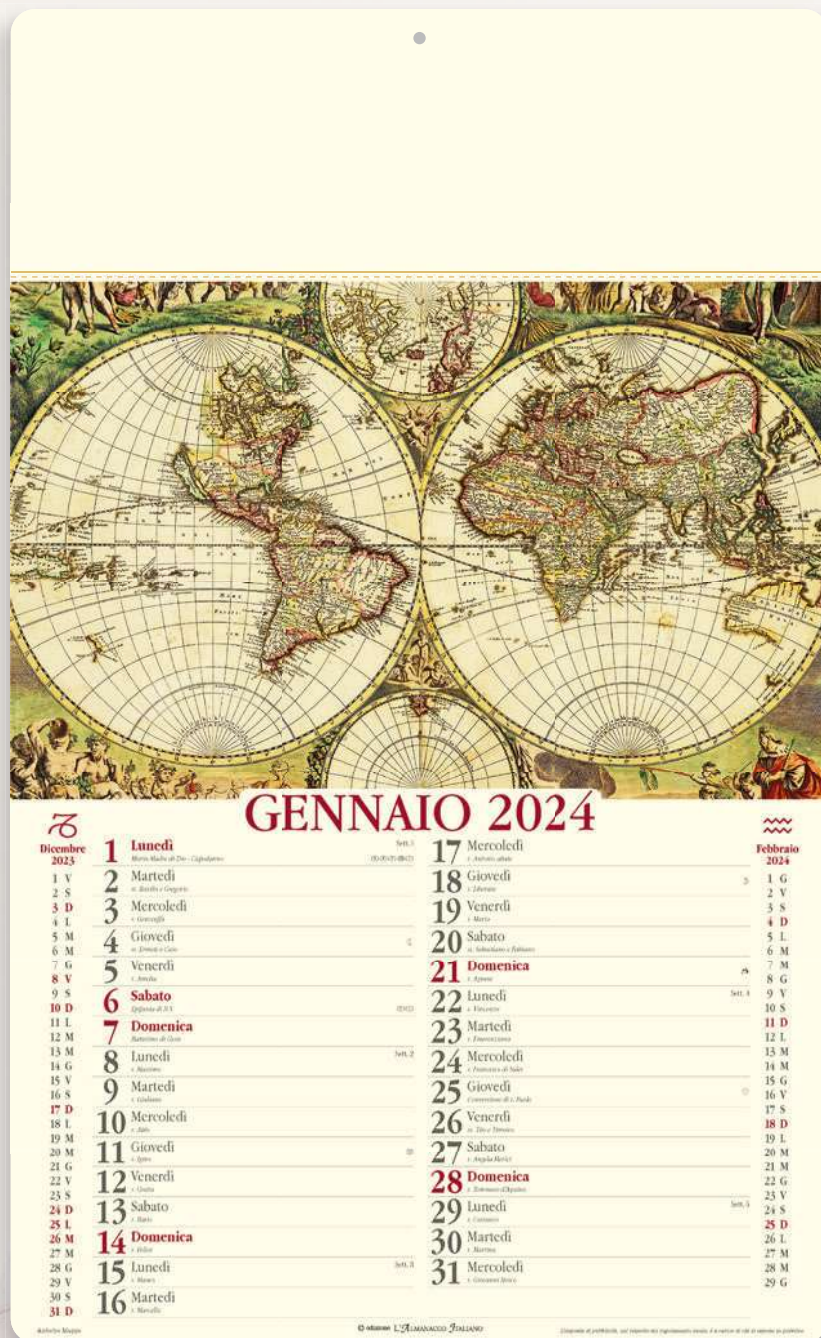

## PA012 Antiche mappe

Illustrato mensile 12 fogli, carta avorio 70 gr  
testata rinforzata



f.to calendario: 31x52,5 cm ca

f.to testata: 31x10,5 cm ca

100



La carta proviene da  
materiale certificato FSC®,  
materiale riciclato e/o legno  
controllato.



Testata  
Extrastrong

# PA014 Italia antica

formato  
31x52,5 cm ca

Festività  
Internazionali

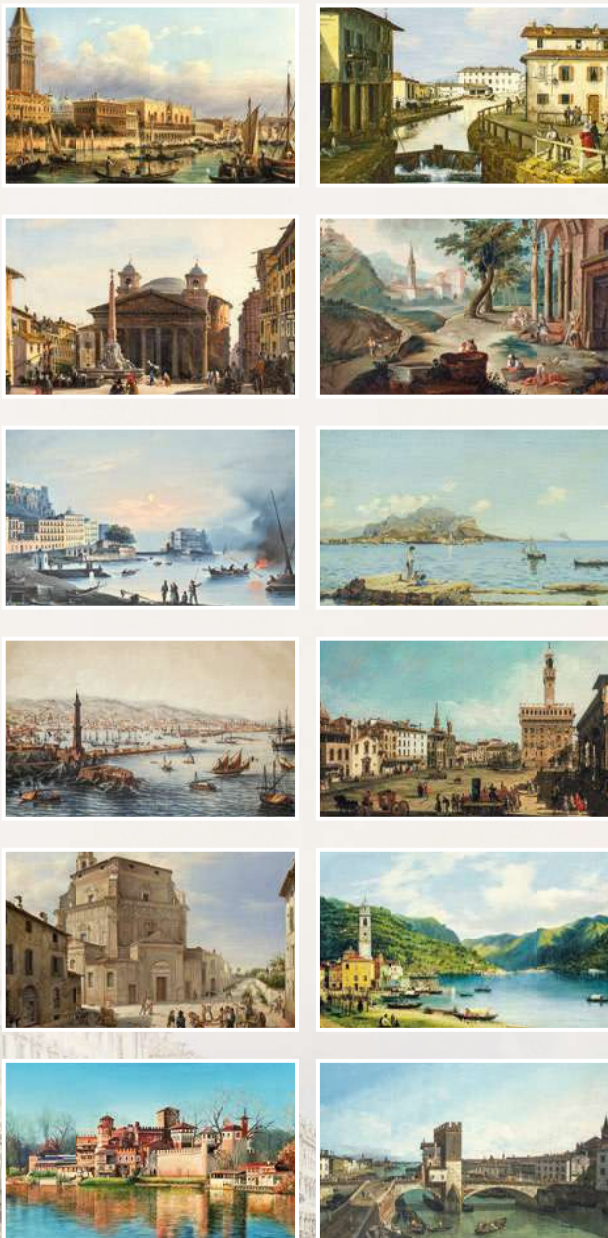

## GENNAIO 2024

Dicembre 2023	1 Lunedì	17 Mercoledì	Febbraio 2024
2 S	2 Martedì s. Basilio e Gregorio	18 Giovedì	1 G
3 D	3 Mercoledì s. Giovanni	19 Venerdì	2 V
4 L	4 Giovedì	20 Sabato	3 S
5 M	5 Venerdì s. Andrea	21 Domenica	4 D
6 M	6 Sabato	22 Lunedì	5 L
7 G	7 Domenica	23 Martedì	6 M
8 V	8 Lunedì	24 Mercoledì	7 M
9 S	9 Martedì	25 Giovedì	8 G
10 D	10 Mercoledì	26 Venerdì	9 V
11 L	11 Giovedì	27 Sabato	10 S
12 M	12 Venerdì	28 Domenica	11 D
13 M	13 Sabato	29 Lunedì	12 L
14 G	14 Domenica	30 Martedì	13 M
15 V	15 Lunedì	31 Mercoledì	14 M
16 S	16 Martedì		15 G
17 D			16 V
18 L			17 S
19 M			18 D
20 M			19 L
21 G			20 M
22 V			21 M
23 S			22 G
24 D			23 V
25 L			24 S
26 M			25 D
27 M			26 L
28 G			27 M
29 V			28 M
30 S			29 G
31 D			

© Almanacco L'ALMANACCO ITALIANO

## PA014 Italia antica

Illustrato mensile 12 fogli, carta avorio 70 gr testata rinforzata



- f.to calendario: 31x52,5 cm ca
- f.to testata: 31x10,5 cm ca
- 100



La carta proviene da materiale certificato FSC®, materiale riciclato e/o legno controllato.



Testata  
Extrastrong

# PA018 Napoli antica

formato  
31x52,5 cm ca

Festività  
Internazionali

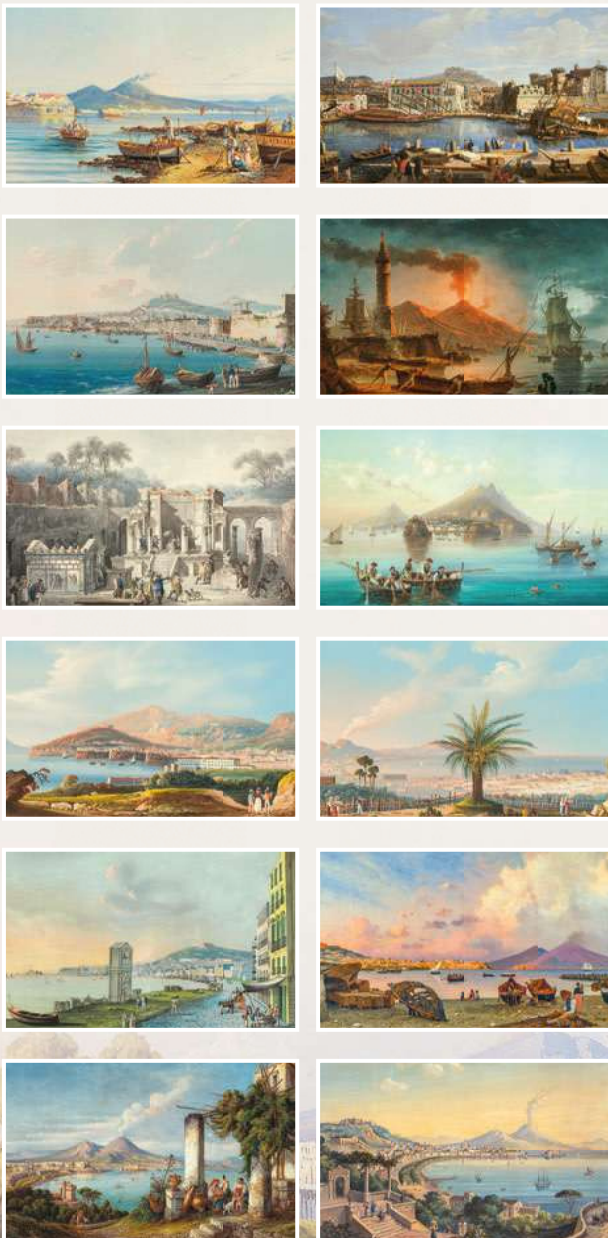

## PA018 Napoli antica

Illustrato mensile 12 fogli, carta avorio 70 gr  
testata rinforzata



f.to calendario: 31x52,5 cm ca

f.to testata: 31x10,5 cm ca

100



La carta proviene da  
materiale certificato FSC®,  
materiale riciclato e/o legno  
controllato.



Testata  
Extrastrong



# PA022 Come eravamo

formato  
31x52,5 cm ca

Festività  
Internazionali



Come giocavamo.

## GENNAIO 2024

<b>1</b> Lunedì Santo Spirito all'Ascensione	<b>17</b> Mercoledì S. Antonio abate	<b>3</b> Venerdì S. Maria	<b>19</b> Venerdì S. Maria
<b>2</b> Martedì S. Basilio e Gregorio	<b>18</b> Giovedì S. Liberato	<b>4</b> Lunedì S. Epifanio	<b>20</b> Sabato S. Sebastiano e Felice
<b>3</b> Mercoledì S. Gerasimo	<b>19</b> Venerdì S. Maria	<b>5</b> Martedì S. Agostino	<b>21</b> Domenica S. Epifania
<b>4</b> Giovedì S. Eusebio e Carlo	<b>20</b> Sabato S. Sebastiano e Felice	<b>6</b> Mercoledì S. Felice	<b>22</b> Lunedì S. Felice
<b>5</b> Venerdì S. Eusebio e Carlo	<b>21</b> Domenica S. Epifania	<b>7</b> Giovedì S. Felice	<b>23</b> Martedì S. Felice
<b>6</b> Sabato S. Felice	<b>22</b> Lunedì S. Felice	<b>8</b> Venerdì S. Felice	<b>24</b> Mercoledì S. Felice
<b>7</b> Domenica S. Felice	<b>23</b> Martedì S. Felice	<b>9</b> Sabato S. Felice	<b>25</b> Giovedì S. Felice
<b>8</b> Lunedì S. Felice	<b>24</b> Mercoledì S. Felice	<b>10</b> Domenica S. Felice	<b>26</b> Venerdì S. Felice
<b>9</b> Martedì S. Felice	<b>25</b> Giovedì S. Felice	<b>11</b> Lunedì S. Felice	<b>27</b> Sabato S. Felice
<b>10</b> Mercoledì S. Felice	<b>26</b> Venerdì S. Felice	<b>12</b> Martedì S. Felice	<b>28</b> Domenica S. Felice
<b>11</b> Giovedì S. Felice	<b>27</b> Sabato S. Felice	<b>13</b> Mercoledì S. Felice	<b>29</b> Lunedì S. Felice
<b>12</b> Venerdì S. Felice	<b>28</b> Domenica S. Felice	<b>14</b> Giovedì S. Felice	<b>30</b> Martedì S. Felice
<b>13</b> Sabato S. Felice	<b>29</b> Lunedì S. Felice	<b>15</b> Venerdì S. Felice	<b>31</b> Mercoledì S. Felice
<b>14</b> Domenica S. Felice		<b>16</b> Sabato S. Felice	

## PA022 Come eravamo

Illustrato mensile 12 fogli, carta avorio 70 gr testata rinforzata



- f.to calendario: 31x52,5 cm ca
- f.to testata: 31x10,5 cm ca
- 100



La carta proviene da materiale certificato FSC®, materiale riciclato e/o legno controllato.



Testata  
Extrastrong

# PA024 San Pio

formato  
31x52,5 cm ca

Festività  
Internazionali

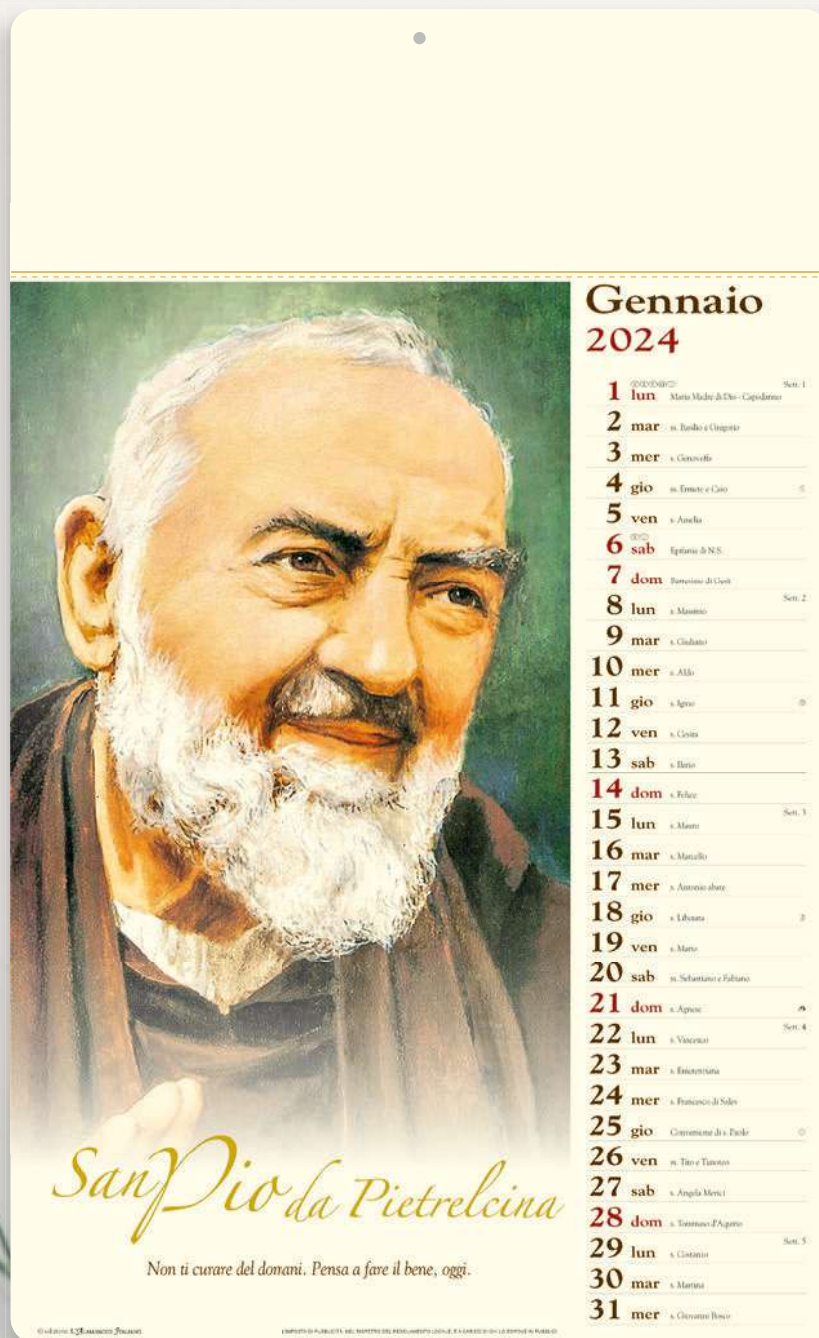

## PA024 San Pio

Illustrato mensile 12 fogli, carta avorio 70 gr  
testata rinforzata



f.to calendario: 31x52,5 cm ca

f.to testata: 31x10,5 cm ca

100



La carta proviene da  
materiale certificato  
FSC®, materiale riciclato  
e/o legno controllato.



Testata  
Extrastrong

# PA032 Artistico

formato  
31x52,5 cm ca

Festività  
Internazionali



Morisset - Il porto di Lorient

## GENNAIO 2024

2023	2024	2024	2024
1 V	<b>1 Lunedì</b> Santo Spirito	<b>17 Mercoledì</b> S. Antonio abate	1 G
2 S	<b>2 Martedì</b> S. Basilio e Gregorio	<b>18 Giovedì</b> S. Liberato	2 V
3 D	<b>3 Mercoledì</b> S. Giovanni	<b>19 Venerdì</b> S. Maria	3 S
4 L	<b>4 Giovedì</b> S. Ambrogio e Carlo	<b>20 Sabato</b> S. Sebastiano e Felice	4 D
5 M	<b>5 Venerdì</b> S. Andrea	<b>21 Domenica</b> S. Epifanio	5 L
6 M	<b>6 Sabato</b> Epifania di Gesù	<b>22 Lunedì</b> S. Felice	6 M
7 G	<b>7 Domenica</b> Sant'Antonio di Padova	<b>23 Martedì</b> S. Eusebio	7 M
8 V	<b>8 Lunedì</b> S. Alessio	<b>24 Mercoledì</b> S. Felice e Adelfo	8 G
9 S	<b>9 Martedì</b> S. Costantino	<b>25 Giovedì</b> Conversione di S. Paolo	9 V
10 D	<b>10 Mercoledì</b> S. Silvestro	<b>26 Venerdì</b> S. Teodoro	10 S
11 L	<b>11 Giovedì</b> S. Spirito	<b>27 Sabato</b> S. Agostino	11 D
12 M	<b>12 Venerdì</b> S. Crispino	<b>28 Domenica</b> S. Tommaso d'Aquino	12 L
13 M	<b>13 Sabato</b> S. Rocco	<b>29 Lunedì</b> S. Costantino	13 M
14 G	<b>14 Domenica</b> S. Felice	<b>30 Martedì</b> S. Stefano	14 M
15 V	<b>15 Lunedì</b> S. Basilio	<b>31 Mercoledì</b> S. Costantino	15 G
16 S	<b>16 Martedì</b> S. Basilio		16 V
17 D			17 S
18 L			18 D
19 M			19 L
20 M			20 M
21 G			21 M
22 V			22 G
23 S			23 V
24 D			24 S
25 L			25 D
26 M			26 L
27 M			27 M
28 G			28 M
29 V			29 G
30 S			
31 D			

© ALMANACCO ITALIANO

## PA032 Artistico

Illustrato mensile 12 fogli, carta avorio 70 gr testata rinforzata



f.to calendario: 31x52,5 cm ca

f.to testata: 31x10,5 cm ca

100



La carta proviene da materiale certificato FSC®, materiale riciclato e/o legno controllato.



Testata  
Extrastrong

# PA062 Antiche mappe

formato 19x14,5 cm ca  Festività Internazionali



Tabella  
2025  
in ultima  
pagina



## PA062 Antiche mappe

Spiralato da tavolo 13 fogli  
carta avorio 90 gr  
supporto cartoncino avorio 450 gr



- f.to calendario: 19x14,5 cm ca
- f.to piedino: 19x3,5 cm ca
- 100

# PA064 Italia antica

formato 19x14,5 cm ca  Festività Internazionali



Tabella 2025 in ultima pagina



## PA064 Italia antica

Spiralato da tavolo 13 fogli carta avorio 90 gr supporto cartoncino avorio 450 gr



- f.to calendario: 19x14,5 cm ca
- f.to piedino: 19x3,5 cm ca
- 100

# PA065 Come eravamo

formato  
19x14,5 cm ca

Festività  
Internazionali



Tabella  
2025  
in ultima  
pagina



## PA065 Come eravamo

Spiralato da tavolo 13 fogli  
carta avorio 90 gr  
supporto cartoncino avorio 450 gr



- f.to calendario: 19x14,5 cm ca
- f.to piedino: 19x3,5 cm ca
- 100



# PA066 Gouaches

formato 19x14,5 cm ca  Festività Internazionali



Tabella 2025 in ultima pagina



## PA066 Gouaches

Spiralato da tavolo 13 fogli  
carta avorio 90 gr  
supporto cartoncino avorio 450 gr



- f.to calendario: 19x14,5 cm ca
- f.to piedino: 19x3,5 cm ca
- 100

GENNAIO 2024

CAPRICORNO 22/12 - 20/1



<b>1 LUN</b>	San Felice e Circeo	08:00
<b>2 MAR</b>	San Felice e Circeo	08:00
<b>3 MER</b>	San Felice e Circeo	08:00
<b>4 GIO</b>	San Felice e Circeo	08:00
<b>5 VEN</b>	San Felice e Circeo	08:00
<b>6 SAB</b>	San Felice e Circeo	08:00
<b>7 DOM</b>	San Felice e Circeo	08:00
<b>8 LUN</b>	San Felice e Circeo	08:00
<b>9 MAR</b>	San Felice e Circeo	08:00
<b>10 MER</b>	San Felice e Circeo	08:00
<b>11 GIO</b>	San Felice e Circeo	08:00
<b>12 VEN</b>	San Felice e Circeo	08:00
<b>13 SAB</b>	San Felice e Circeo	08:00
<b>14 DOM</b>	San Felice e Circeo	08:00
<b>15 LUN</b>	San Felice e Circeo	08:00
<b>16 MAR</b>	San Felice e Circeo	08:00
<b>17 MER</b>	San Felice e Circeo	08:00
<b>18 GIO</b>	San Felice e Circeo	08:00
<b>19 VEN</b>	San Felice e Circeo	08:00
<b>20 SAB</b>	San Felice e Circeo	08:00
<b>21 DOM</b>	San Felice e Circeo	08:00
<b>22 LUN</b>	San Felice e Circeo	08:00
<b>23 MAR</b>	San Felice e Circeo	08:00
<b>24 MER</b>	San Felice e Circeo	08:00
<b>25 GIO</b>	San Felice e Circeo	08:00
<b>26 VEN</b>	San Felice e Circeo	08:00
<b>27 SAB</b>	San Felice e Circeo	08:00
<b>28 DOM</b>	San Felice e Circeo	08:00
<b>29 LUN</b>	San Felice e Circeo	08:00
<b>30 MAR</b>	San Felice e Circeo	08:00
<b>31 MER</b>	San Felice e Circeo	08:00

DICEMBRE 2023							FEBBRAIO 2024						
LUN	MAR	MER	GIO	VEN	SAB	DOM	LUN	MAR	MER	GIO	VEN	SAB	DOM
4	5	6	7	8	9	10	5	6	7	8	9	10	11
11	12	13	14	15	16	17	12	13	14	15	16	17	18
18	19	20	21	22	23	24	19	20	21	22	23	24	25
25	26	27	28	29	30	31	26	27	28	29			

**IL SOLE E LA LUNA**

**SOLE** tramonta  
**TRAMONTA**  
**SOLE** tramonta  
**TRAMONTA**

Nota: la tavola è il risultato del ciclo ripetuto nel calendario di riferimento sempre all'ora vera.



# PA100 San Pio

formato 29x47 cm ca

Festività Internazionali

## GENNAIO

**1 LUN** San Pio San 1

**2 MAR** San Pio 1.100

**3 MER** San Pio 2.300

**4 GIO** San Pio 3.500

**5 VEN** San Pio 4.700

**6 SAB** San Pio 5.900

**7 DOM** San Pio San 2

**8 LUN** San Pio 8.100

**9 MAR** San Pio 9.300

**10 MER** San Pio 10.500

**11 GIO** San Pio 11.700

**12 VEN** San Pio 12.900

**13 SAB** San Pio 14.100

**14 DOM** San Pio San 3

**15 LUN** San Pio 15.300

**16 MAR** San Pio 16.500

**17 MER** San Pio 17.700

**18 GIO** San Pio 18.900

**19 VEN** San Pio 20.100

**20 SAB** San Pio 21.300

**21 DOM** San Pio San 4

**22 LUN** San Pio 22.500

**23 MAR** San Pio 23.700

**24 MER** San Pio 24.900

**25 GIO** San Pio 26.100

**26 VEN** San Pio 27.300

**27 SAB** San Pio 28.500

**28 DOM** San Pio San 5

**29 LUN** San Pio 29.700

**30 MAR** San Pio 30.900

**31 MER** San Pio 32.100

DICEMBRE 2023						
LUN	MAR	MER	GIO	VEN	SAB	DOM
4	5	6	7	8	9	10
11	12	13	14	15	16	17
18	19	20	21	22	23	24
25	26	27	28	29	30	31

2024

FEBBRAIO 2024						
LUN	MAR	MER	GIO	VEN	SAB	DOM
5	6	7	8	9	10	11
12	13	14	15	16	17	18
19	20	21	22	23	24	25
26	27	28	29			

### San Pio da Pietrelcina

#### L'infanzia e la vocazione

Il 15 maggio 1857 nasce a Pietrelcina, provincia e diocesi di Benevento, il quarto figlio di Francesco Forgione e Maria Giuseppa De Antonio. Il giorno seguente viene battezzato col nome di Francesco.

Senza la vocazione religiosa a cinque anni, quando promette di consacrarsi per sempre al Signore.

A tredici anni già si sottopone a dure penitenze, si difende dagli attacchi dei demoni ed consolato da santi e ottimali apparizioni.

Per farlo studiare e per mantenere la famiglia il nonno a Pietrelcina non basta e papa Leone decide di impiegare oltre oceanico.

Nel frattempo la sorella di Francesco si dedica con chiarezza. Vuole diventare suora con la badessa ma nel momento dei Cappuccini non ci sono posti disponibili. Parenti e amici tentano invano di convincerla a sposare con qualche altra famiglia religiosa.

Finalmente un prete di Pietrelcina il 4 gennaio 1874 Francesco lo convince con una lettera di accettazione della Provincia di Sant'Antonio di Padova. Oggi abitualmente la Santa Madre e Padre Pio a Roma come sempre in provincia di Benevento, a pochi chilometri da Pietrelcina.

Vive l'ultimo da novembre il 22 gennaio occasione per cui il nome di fra Pio. È fatto nostro dopo un anno assume la professione temporanea dei voti, che conferma definitivamente a Sant'Elia a Pianisi, vicino a Campobasso, il 27 gennaio del 1867.

Più tardi, per motivi di salute, il giovane fra Pio è costretto a lasciare il convento e gli studi. È costretto a gli consigliano di tornare a Pietrelcina per recuperare l'aria del paese naturo, in effetti qui i sintomi si attenuano, un mese più le ragioni ipotizzate dagli amici di scienza.

#### Atto di affidamento a San Pio

O glorioso San Pio da Pietrelcina,  
tu che sei il Santo di questo nuovo millennio,  
tu che sei nostro amico,  
consolatore delle nostre anime, aiuto di noi peccatori,  
che per la tua sofferenza  
comprendi benissimo tutte le nostre sofferenze,  
a te affidiamo le richieste di te per noi e per i nostri cari,  
a te affidiamo il nostro spirito  
per renderlo capace di sopportare  
tutte le pene che abbiamo nel cuore;  
a te affidiamo la supplica di presentare  
le nostre anime alla Vergine delle Grazie  
per ottenere dal Signore eterna salvezza;  
a te affidiamo la nostra schiacciata di intercessione  
per ottenere dalla Bontà divina la grazia  
che ardentemente desideriamo.  
Accoglici sotto la tua protezione,  
difendici dalle insidie del maligno  
e soprattutto intercali presso l'Altissimo  
perché col perdono dei nostri peccati diventiamo  
perseveranti nelle vie del bene.

## PA100 San Pio

Illustrato mensile 12 fogli, carta patinata 70 gr, testata termosaldada

f.to calendario: 29x47 cm ca

f.to testata: 29x9 cm ca

100

63

# PA101 Francesco

formato 29x47 cm ca

Festività Internazionali

Retrostampato

## PAPA FRANCESCO



### LE VIE PER LA CARITA'

Tre 're per la carità. Papa Francesco le ha indicate ai partecipanti all'udienza che ha presieduto ai rappresentanti di Caritas Italiana. "Nell'attuale cambiamento d'epoca le sfide e le difficoltà sono tante, sono assenze di più i colli del pozzo e la situazione complessa sul territorio" ha detto il Pap. Francesco indica la via degli ultimi, via di misericordia e ricorda che "molte scelte significative, hanno aiutato le Caritas e le Chiese locali a praticare questa misericordia: dall'obiezione di coscienza al sostegno al volontariato; dall'impegno nella cooperazione con il Sud del pianeta agli interventi in occasione di emergenza in Italia e nel mondo; dall'approccio globale al complesso fenomeno delle migrazioni, con proposte innovative come i corridoi umanitari, all'attivazione di strumenti capaci di avvicinare la realtà, come i Centri di ascolto e gli Osservatori della povertà e delle disuguaglianze". Sono i poveri che mettono il dito nella piaga delle nostre contraddizioni e inquietano la nostra coscienza in modo salutare, invitandoci al cambiamento. Irriunciabile la via del Vangelo, uno stile di avere. E "la carità è inclusiva, non si occupa solo dell'aspetto materiale e nemmeno solo di quello spirituale. La salvezza di Gesù abbraccia l'uomo intero. Abbiamo bisogno di una carità dedicata allo sviluppo integrale della persona: una carità spirituale, materiale, intellettuale". Il Papa ricorda l'espressione di Giovanni Paolo II "l'uomo è la via della Chiesa". E aggiunge che "dalle forti espressioni di giudizio del Signore ricaviamo anche l'invito alla parità della denuncia. Essa non è mai polemica contro qualcuno, ma profezia per tutti: e proclamare la dignità umana quando è calpesta, è far udire il grido soffocato dei poveri, è dare voce a chi non se ha". Infine la creatività come terra via: "Non lasciatevi scoraggiare di fronte ai numeri crescenti di nuovi poveri e di nuove povertà. Continuate a coltivare segni di fraternità e ad essere segni di speranza. Contro il virus del pessimismo, immunizzatevi condividendo la gioia di essere una grande famiglia".

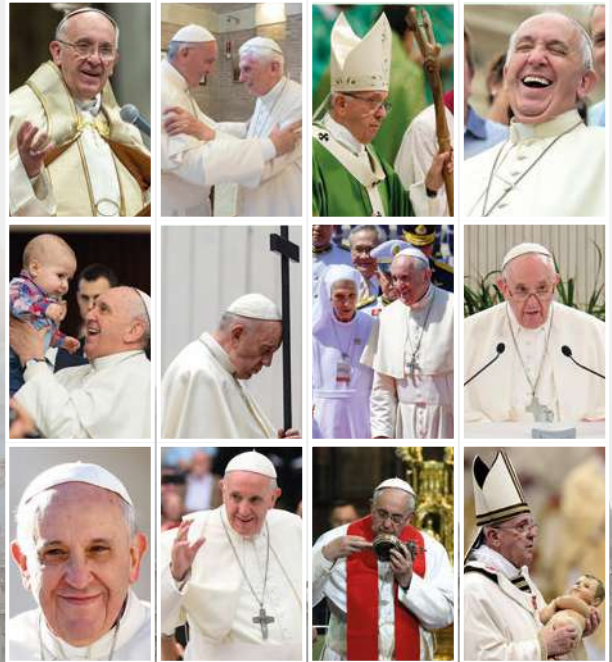

## GENNAIO

*« Dio non si sanna mai di peccatori, sanna chi a cominciano di chiedere la sua misericordia. »*

1 LUN	Epifania	San 1
2 MAR	Prima Giornata del Capolavoro	1.300
3 MER	San Giuseppe	3.300
4 GIO	San Giuseppe (2)	3.300
5 VEN	San Giuseppe (3)	3.300
6 SAB	Epifania (2)	4.300
7 DOM	Battesimo di Gesù	1.300
8 LUN	San Giuseppe (4)	3.300
9 MAR	San Giuseppe (5)	3.300
10 MER	San Giuseppe (6)	3.300
11 GIO	San Giuseppe (7)	3.300
12 VEN	San Giuseppe (8)	3.300
13 SAB	San Giuseppe (9)	3.300
14 DOM	San Giuseppe (10)	3.300
15 LUN	San Giuseppe (11)	3.300
16 MAR	San Giuseppe (12)	3.300
17 MER	San Giuseppe (13)	3.300
18 GIO	San Giuseppe (14)	3.300
19 VEN	San Giuseppe (15)	3.300
20 SAB	San Giuseppe (16)	3.300
21 DOM	San Giuseppe (17)	3.300
22 LUN	San Giuseppe (18)	3.300
23 MAR	San Giuseppe (19)	3.300
24 MER	San Giuseppe (20)	3.300
25 GIO	San Giuseppe (21)	3.300
26 VEN	San Giuseppe (22)	3.300
27 SAB	San Giuseppe (23)	3.300
28 DOM	San Giuseppe (24)	3.300
29 LUN	San Giuseppe (25)	3.300
30 MAR	San Giuseppe (26)	3.300
31 MER	San Giuseppe (27)	3.300

DICEMBRE 2023					FEBBRAIO 2024								
LUN	MAR	MER	GIO	VEN	SAB	DOM	LUN	MAR	MER	GIO	VEN	SAB	DOM
4	5	6	7	8	9	10	5	6	7	8	9	10	11
11	12	13	14	15	16	17	12	13	14	15	16	17	18
18	19	20	21	22	23	24	19	20	21	22	23	24	25
25	26	27	28	29	30	31	26	27	28	29			

# 2024

## PA101 Francesco

Illustrato mensile 12 fogli, carta patinata 70 gr, testata termosaldada



f.to calendario: 29x47 cm ca

f.to testata: 29x9 cm ca

100



# PA091 Ecologia

formato 29x47 cm ca



Festività Internazionali

## Il Calendario dell'ecologia GENNAIO

1	Lunedì	1-365	Maria Madre di Dio - Capodanno
2	Martedì	2-364	ss. Basilio e Gregorio
3	Mercoledì	3-363	s. Ginevra
4	Giovedì	4-362	ss. Ermete e Caio
5	Venerdì	5-361	s. Amelia
6	Sabato	6-360	Epifania di N.S.
7	Domenica	7-359	Battesimo di Gesù
8	Lunedì	8-358	s. Massimo
9	Martedì	9-357	s. Giuliano
10	Mercoledì	10-356	s. Aldo
11	Giovedì	11-355	s. Igino
12	Venerdì	12-354	s. Costia
13	Sabato	13-353	s. Ilario
14	Domenica	14-352	s. Felice
15	Lunedì	15-351	s. Mirco
16	Martedì	16-350	s. Marcello
17	Mercoledì	17-349	s. Antonio abate
18	Giovedì	18-348	s. Libera
19	Venerdì	19-347	s. Mario
20	Sabato	20-346	ss. Sebastiano e Feliciano
21	Domenica	21-345	s. Agnese
22	Lunedì	22-344	s. Vincenzo
23	Martedì	23-343	s. Emerenziana
24	Mercoledì	24-342	s. Francesco di Sales
25	Giovedì	25-341	Conversione di s. Paolo
26	Venerdì	26-340	ss. Tito e Timoteo
27	Sabato	27-339	s. Angela Merici
28	Domenica	28-338	s. Tommaso d'Aquino
29	Lunedì	29-337	s. Costanzo
30	Martedì	30-336	s. Martina
31	Mercoledì	31-335	s. Giovanni Bosco

### Emergenza idrica: scarsità d'acqua

L'acqua è abbondante nel nostro pianeta, copre il 71% della superficie, ma solo il 2,5% di questa è dolce, se poi escludiamo i ghiacciai e i poli ne resta meno dell'1%. Di questo 1% solo lo 0,1 è destinato al consumo umano. Questa disponibilità d'acqua viene oggi influenzata dai cambiamenti climatici in corso, che stanno modificando la struttura ecologica del nostro pianeta, incidendo sia sui fattori climatici primari come temperatura e umidità, sia su quelli secondari, come l'evaporazione. L'intero ciclo dell'acqua ne è coinvolto e anche l'Italia ne è soggetta, pur non essendo corretto parlare di "fropicalizzazione" poiché non è possibile distinguere la stagione piovosa da quella secca. Sono sempre più evidenti e drammatici fenomeni come quello dei prefrughi climatici, provenienti soprattutto da alcune regioni dell'Africa. E anche in Italia si stanno verificando sempre più spesso periodi di prolungata siccità e di precipitazioni intense e concentrate in brevi periodi. Una conseguenza immediata è il razionamento dell'acqua potabile in alcune situazioni limite, ma è difficile prevedere gli effetti di medio lungo periodo.

DICEMBRE 2023				
Lunedì	Martedì	Mercoledì	Giovedì	Venerdì
4	5	6	7	8
11	12	13	14	15
18	19	20	21	22
25	26	27	28	29

2024

FEBBRAIO 2024				
Lunedì	Martedì	Mercoledì	Giovedì	Venerdì
5	6	7	8	9
12	13	14	15	16
19	20	21	22	23
26	27	28	29	

## L'ACQUA POTABILE UNA RISORSA INDISPENSABILE E UN DIRITTO

Creare l'acqua potabile è diventato un problema comune non solo per i paesi più poveri del mondo ma anche per le zone più ricche e coltivate. A causa dei cambiamenti climatici, dell'inquinamento e degli sprechi, anche in Italia, soprattutto in estate, tende a essere sempre più difficile che reperirla. Il bel paese non diventa desertico: gli acquedotti hanno una percentuale media di dispersione circa pari al 30%, percentuale che nelle isole di terra si può addirittura raddoppiare. L'assottigliamento delle risorse idriche è diventato un problema serio per tutti i paesi del mondo. Quando questa condizione idrica si prolunga in lungo e in largo sul territorio, come è avvenuto in questi ultimi anni, si creano una serie di complicazioni, generate dalla distribuzione delle colture e dall'irrigazione che avviene, dagli elementi che influenzano maggiormente sul territorio e sulla popolazione. L'acqua è un bene prezioso, ma, purtroppo, il fatto di poterla disporre si è ridotto e, in alcuni casi, è diventato un problema. Comincia una serie di altri squilibri e si va verso un futuro, in cui, in ogni caso, si dovrà trovare una soluzione che l'acqua sia una risorsa in esaurimento. Oltre alle zone povere e sottosviluppate del mondo, anche le nostre zone tendono a diventare povere e sotto-sviluppate in estate, soprattutto durante le stagioni più calde.

### COSA FARE PER USARE E TRATTARE MEGLIO L'ACQUA

Se si riuscirà a riciclarla, invece che quella in bottiglia, preferire l'utilizzo della doccia al bagno in vasca e chiudere il rubinetto dell'acqua mentre si lava i denti o fa la barba. Riutilizza l'acqua del lavaggio delle verdure o della cottura della pasta per innaffiare le piante. Riduci l'uso della plastica, in particolare quella monouso e per il confezionamento di cibi e bevande. Le microplastiche contaminano l'acqua e di conseguenza la catena alimentare. Impegnati a far crescere consapevolezza e responsabilità circa la tutela e il risparmio di questa preziosa e unica risorsa.

**Emergenza idrica: scarsità d'acqua**

L'acqua è abbondante nel nostro pianeta, ma solo il 2,5% di questa è dolce, se poi escludiamo i ghiacciai e i poli ne resta meno dell'1%. Di questo 1% solo lo 0,1 è destinato al consumo umano. Questa disponibilità d'acqua viene oggi influenzata dai cambiamenti climatici in corso, che stanno modificando la struttura ecologica del nostro pianeta, incidendo sia sui fattori climatici primari come temperatura e umidità, sia su quelli secondari, come l'evaporazione. L'intero ciclo dell'acqua ne è coinvolto e anche l'Italia ne è soggetta, pur non essendo corretto parlare di "fropicalizzazione" poiché non è possibile distinguere la stagione piovosa da quella secca. Sono sempre più evidenti e drammatici fenomeni come quello dei prefrughi climatici, provenienti soprattutto da alcune regioni dell'Africa. E anche in Italia si stanno verificando sempre più spesso periodi di prolungata siccità e di precipitazioni intense e concentrate in brevi periodi. Una conseguenza immediata è il razionamento dell'acqua potabile in alcune situazioni limite, ma è difficile prevedere gli effetti di medio lungo periodo.

**Parla la scienza: acqua e inquinamento**

L'acqua è un bene prezioso, ma, purtroppo, il fatto di poterla disporre si è ridotto e, in alcuni casi, è diventato un problema. Comincia una serie di altri squilibri e si va verso un futuro, in cui, in ogni caso, si dovrà trovare una soluzione che l'acqua sia una risorsa in esaurimento. Oltre alle zone povere e sottosviluppate del mondo, anche le nostre zone tendono a diventare povere e sotto-sviluppate in estate, soprattutto durante le stagioni più calde.

**Ridurre l'uso della plastica**

Riduci l'uso della plastica, in particolare quella monouso e per il confezionamento di cibi e bevande. Le microplastiche contaminano l'acqua e di conseguenza la catena alimentare. Impegnati a far crescere consapevolezza e responsabilità circa la tutela e il risparmio di questa preziosa e unica risorsa.

**La fonte di energia rinnovabile**

Le energie rinnovabili sono quelle che provengono da fonti inesauribili e pulite. Sono un'alternativa sostenibile e rispettosa per l'ambiente. Utilizzare energia rinnovabile per alimentare i tuoi dispositivi e ridurre il tuo impatto ambientale.

**Chi usa bene i lavastoviglie**

Per fare questo il pieno necessario, è importante che l'acqua venga riciclata e riutilizzata. Ecco alcuni consigli per limitare eventuali sprechi di acqua.

**La nuova fonte di mobilità**

Le auto elettriche sono una soluzione sostenibile e rispettosa per l'ambiente. Ridurre il tuo consumo di carburante e contribuire a ridurre le emissioni di CO2.

**Biodiversità: salvaguardare la natura**

La biodiversità è un bene prezioso che ci offre molti servizi ecosistemici. Proteggere la natura e le specie che la abitano è fondamentale per il nostro futuro.

**Le principali forme di inquinamento**

L'inquinamento è un problema globale che ha molte facce. Ridurre il tuo consumo di plastica, carta e altri materiali non biodegradabili è un modo per contribuire a ridurre l'inquinamento.

**Come diventare un'industria sostenibile**

Le industrie possono contribuire a ridurre il loro impatto ambientale adottando pratiche sostenibili. Utilizzare energia rinnovabile, ridurre i consumi e riciclare i rifiuti sono alcuni modi per farlo.

**Come ridurre l'uso della plastica**

Ridurre l'uso della plastica è un modo per ridurre il tuo impatto ambientale. Scegliere prodotti biodegradabili e riciclabili, evitare la plastica monouso e riciclare i rifiuti.

**La grande sfida: energia e acqua**

La produzione di energia e acqua sono strettamente legate. Ridurre i consumi e utilizzare fonti rinnovabili sono modi per ridurre il tuo impatto ambientale.

**L'importanza del riciclo**

Il riciclo è un modo per ridurre il consumo di risorse e ridurre l'inquinamento. Riciclare i rifiuti è un dovere di tutti.

## PA091 Ecologia

Illustrato mensile 12 fogli, carta patinata 70 gr testata termosaldata



- f.to calendario: 29x47 cm ca
- f.to testata: 29x9 cm ca
- 100





# PA108 Cani e gatti

formato  
29x47 cm ca

Festività  
Internazionali

## GENNAIO 2024



**CAPRICORNO 22/12 - 20/1**

1 LUN	San.1
2 MAR	11.04
3 MER	11.04
4 GIO	11.04
5 VEN	11.04
6 SAB	11.04
7 DOM	11.04
8 LUN	11.04
9 MAR	11.04
10 MER	11.04
11 GIO	11.04
12 VEN	11.04
13 SAB	11.04
14 DOM	11.04
15 LUN	11.04
16 MAR	11.04
17 MER	11.04
18 GIO	11.04
19 VEN	11.04
20 SAB	11.04
21 DOM	11.04
22 LUN	11.04
23 MAR	11.04
24 MER	11.04
25 GIO	11.04
26 VEN	11.04
27 SAB	11.04
28 DOM	11.04
29 LUN	11.04
30 MAR	11.04
31 MER	11.04

DICEMBRE 2023						
LUN	MAR	MER	GIO	VEN	SAB	DOM
4	5	6	7	8	9	10
11	12	13	14	15	16	17
18	19	20	21	22	23	24
25	26	27	28	29	30	31

FEBBRAIO 2024						
LUN	MAR	MER	GIO	VEN	SAB	DOM
1	2	3	4	5	6	7
8	9	10	11	12	13	14
15	16	17	18	19	20	21
22	23	24	25	26	27	28
29	30	31				

### IL SOLE E LA LUNA

SOGG. TRAMONTO: ☀️ 07.00, ☀️ 08.00, ☀️ 09.00, ☀️ 10.00, ☀️ 11.00, ☀️ 12.00, ☀️ 13.00, ☀️ 14.00, ☀️ 15.00, ☀️ 16.00, ☀️ 17.00, ☀️ 18.00, ☀️ 19.00, ☀️ 20.00, ☀️ 21.00, ☀️ 22.00, ☀️ 23.00, ☀️ 24.00, ☀️ 25.00, ☀️ 26.00, ☀️ 27.00, ☀️ 28.00, ☀️ 29.00, ☀️ 30.00, ☀️ 31.00  
 SOGG. ALZATA: ☀️ 17.00, ☀️ 18.00, ☀️ 19.00, ☀️ 20.00, ☀️ 21.00, ☀️ 22.00, ☀️ 23.00, ☀️ 24.00, ☀️ 25.00, ☀️ 26.00, ☀️ 27.00, ☀️ 28.00, ☀️ 29.00, ☀️ 30.00, ☀️ 31.00

Retrostampato

## QUANTO C'È DA SAPERE SULLE VACCINAZIONI DEL CANE



### PERCHÉ È IMPORTANTE VACCINARE IL CANE?

I vaccini aiutano a proteggere il sistema immunitario del cane, a prevenire le malattie infettive, a ridurre il rischio di contrarre malattie gravi, a prevenire le zoonosi, a prevenire le malattie che possono essere trasmesse all'uomo, a prevenire le malattie che possono essere trasmesse ad altri animali, a prevenire le malattie che possono essere trasmesse all'ambiente.

### I VACCINI OBBLIGATORI

Parvovirus canino, Canicola, Epatite, Leptospirosi, Rabbia.

### I VACCINI FACOLTATIVI

Rabbia, Influenza canina, Morbillo di Lyme, Leishmaniosi.



### QUANDO INIZIARE LE VACCINAZIONI

In generale, un cucciolo dovrebbe iniziare i vaccini di solito tra i 6 e le 8 settimane per poi continuare con tre settimane fino a circa quattro mesi quando riceverà l'ultima somministrazione. In generale, molti cuccioli ricevono la prima dose attraverso il latte materno durante il lattamento. Dopo che il cucciolo è stato svezzato il latte materno, si dovrebbero iniziare le vaccinazioni.

### PROGRAMMA DI VACCINAZIONE

8-10 settimane: DHP2, tosse dei cani  
11-14 settimane: Cani, Leptospirosi, Influenza canina, Morbillo di Lyme, Rabbia  
15-16 settimane: Cani, Leptospirosi, Influenza canina, Morbillo di Lyme, Rabbia





## PA108 Cani e gatti

Illustrato mensile 12 fogli, carta patinata 70 gr, testata termosaldata



☑️ f.to calendario: 29x47 cm ca

☑️ f.to testata: 29x9 cm ca

☑️ 100



# PA114 Cabala

formato 29x47 cm ca



Festività Internazionali

## GENNAIO 2024

<b>1</b> LUNEDI		<b>17</b> MERCOLEDI	
<b>2</b> MARTEDI		<b>18</b> GIOVEDI	
<b>3</b> MERCOLEDI		<b>19</b> VENERDI	
<b>4</b> GIOVEDI		<b>20</b> SABATO	
<b>5</b> VENERDI		<b>21</b> DOMENICA	
<b>6</b> SABATO		<b>22</b> LUNEDI	
<b>7</b> DOMENICA		<b>23</b> MARTEDI	
<b>8</b> LUNEDI		<b>24</b> MERCOLEDI	
<b>9</b> MARTEDI		<b>25</b> GIOVEDI	
<b>10</b> MERCOLEDI		<b>26</b> VENERDI	
<b>11</b> GIOVEDI		<b>27</b> SABATO	
<b>12</b> VENERDI		<b>28</b> DOMENICA	
<b>13</b> SABATO		<b>29</b> LUNEDI	
<b>14</b> DOMENICA		<b>30</b> MARTEDI	
<b>15</b> LUNEDI		<b>31</b> MERCOLEDI	
<b>16</b> MARTEDI			

**DICEMBRE 2023**

LUN	MAR	MER	GIO	VEN	SAB	DOM
4	5	6	7	8	9	10
11	12	13	14	15	16	17
18	19	20	21	22	23	24
25	26	27	28	29	30	31

**FEBBRAIO 2024**

LUN	MAR	MER	GIO	VEN	SAB	DOM
1	2	3	4	5	6	7
8	9	10	11	12	13	14
15	16	17	18	19	20	21
22	23	24	25	26	27	28

## LA TOMBOLA le cartelle

16	21	31	42	60	17	24	31	41	51
1	18	33	53	62	2	25	43	70	81
2	38	55	69	74	3	36	44	52	63
7	34	69	72	85	10	22	63	77	80
24	38	51	73	89	2	25	53	65	84
8	18	39	40	75	17	28	31	57	69
1	13	21	62	84	7	10	30	40	52
4	16	52	70	86	12	33	46	63	75
17	23	57	73	89	8	16	35	47	77
1	40	57	70	83	10	34	54	71	88
2	12	29	49	85	3	11	25	68	75
5	14	32	59	65	9	13	42	57	76

Ritaglia cartelle e tabellone stampati sui retro

## LA TOMBOLA il tabellone

1	2	3	4	5	6	7	8	9	10
11	12	13	14	15	16	17	18	19	20
21	22	23	24	25	26	27	28	29	30
31	32	33	34	35	36	37	38	39	40
41	42	43	44	45	46	47	48	49	50
51	52	53	54	55	56	57	58	59	60
61	62	63	64	65	66	67	68	69	70
71	72	73	74	75	76	77	78	79	80
81	82	83	84	85	86	87	88	89	90

## PA114 Cabala

Illustrato mensile 12 fogli, carta patinata 70 gr testata termosaldata



- f.to calendario: 29x47 cm ca
- f.to testata: 29x9 cm ca
- 100



# PA115 4 stagioni

formato  
29x47 cm ca



Festività  
Internazionali

Retrostampato

## GENNAIO

**1 LUNEDÌ** 1-308 Maria Madre di Dio - Capodanno **Sett. 1**

**2 MARTEDÌ** 2-304 ss. Basilio e Gregorio

**3 MERCOLEDÌ** 3-263 s. Genoveffa

**4 GIOVEDÌ** 4-307 ss. Ermete e Cialo

**5 VENERDÌ** 5-341 s. Amalia

**6 SABATO** 6-340 Epifania di N.S.

**7 DOMENICA** 7-308 Battesimo di Gesù

**8 LUNEDÌ** 8-358 s. Massimo **Sett. 2**

**9 MARTEDÌ** 9-257 s. Giuliano

**10 MERCOLEDÌ** 10-354 s. Aldo

**11 GIOVEDÌ** 11-325 s. Iginio

**12 VENERDÌ** 12-354 s. Cesira

**13 SABATO** 13-303 s. Ilario

**14 DOMENICA** 14-352 s. Felice

**15 LUNEDÌ** 15-331 s. Mauro **Sett. 3**

**16 MARTEDÌ** 16-350 s. Marcello

**MERCOLEDÌ 17** 17-349 s. Antonio abate

**GIOVEDÌ 18** 18-348 s. Liberato

**VENERDÌ 19** 19-347 s. Mario

**SABATO 20** 20-248 ss. Sebastiano e Feliciano

**DOMENICA 21** 21-343 s. Agnese

**LUNEDÌ 22** 22-344 s. Vincenzo **Sett. 4**

**MARTEDÌ 23** 23-343 s. Emerenziana

**MERCOLEDÌ 24** 24-342 s. Francesco di Sales

**GIOVEDÌ 25** 25-341 Conversione di s. Paolo

**VENERDÌ 26** 26-340 ss. Tito e Timoteo

**SABATO 27** 27-339 s. Angelo Maria

**DOMENICA 28** 28-338 s. Tommaso d'Aquino

**LUNEDÌ 29** 29-337 s. Costanzo **Sett. 5**

**MARTEDÌ 30** 30-336 s. Martina

**MERCOLEDÌ 31** 31-335 s. Ottaviano e Donato

**2024**

DICEMBRE 2023						
Lunedì	Martedì	Mercoledì	Giovedì	Venerdì	Sabato	Domenica
4	5	6	7	8	9	10
11	12	13	14	15	16	17
18	19	20	21	22	23	24
25	26	27	28	29	30	31

FEBBRAIO 2024						
Lunedì	Martedì	Mercoledì	Giovedì	Venerdì	Sabato	Domenica
5	6	7	8	9	10	11
12	13	14	15	16	17	18
19	20	21	22	23	24	25
26	27	28	29			

### INVERNO GENNAIO

**IL PERIODO PIÙ FREDDO**  
L'idea che sia dicembre il mese più freddo dell'inverno, solo per via delle giornate più corte dell'anno, è un'erronea illusione. In Italia, come in tutto il mondo, il periodo invernale più freddo inizia a inizio di gennaio, con un minimo tra il 15 gennaio e il 15 febbraio. Nel mese di gennaio, le precipitazioni sono alte e sufficienti a garantire un ricambio assicurativo del terreno. Il febbraio rappresenta il mese migliore, ovvero il mese in cui l'alternanza del tempo garantisce la massima elasticità, rispetto a quello offerto dal sole. La dicembre una caduta decisa della temperatura, che persiste per tutto il mese di gennaio, poco rispetto la garanzia comunque di alleggeriti.

**I GIORNI DELLA MERLA**  
Si tratta il sei mese, immensamente invernale. Gennaio (ovvero del gale) è un mese, immensamente invernale. Gennaio (ovvero del gale) è un mese, immensamente invernale. Gennaio (ovvero del gale) è un mese, immensamente invernale. Gennaio (ovvero del gale) è un mese, immensamente invernale.

**COSA SEMINARE A GENNAIO**  
In gennaio, con la pioggia e nelle quelle quelle che vengono colte bene e le grandi, come a gennaio, non hanno la piena siccità come, luglio, agosto e settembre. I grandi classici del periodo invernale sono: carciofi, verze, cavoli e ortaggi della stessa famiglia che possono essere messi a dimora direttamente in campo. Si possono anche piantare i fave e piselli e, in genere, piselli, soprattutto nelle regioni del Nord, dove il clima è più freddo. In questo periodo tendono a far buone le germinazioni.

**SEGNO ZODIACALE DI GENNAIO**  
Il primo segno di gennaio è il Capricorno. Ha il carattere influenzato chiunque sia nato dal 22 dicembre al 20 gennaio. È considerato un segno ambizioso, perché anche il suo successo va ottenuto a gennaio, ovvero ogni cosa dopo stagione autunnale, rispetto al Segno, segue che la previsione dell'anno rimbombante. Il Capricorno è riflessivo e prudente, dotato di una personalità a una determinazione. Il suo punto, però, come tutti i segni di terra vuole di essere troppo materialista e materialista. Proprio come Toro e Vergine o i segni d'Acqua del Cancro e del Picco, nel Capricorno si racconta un forte attaccamento alle famiglie e agli usi.

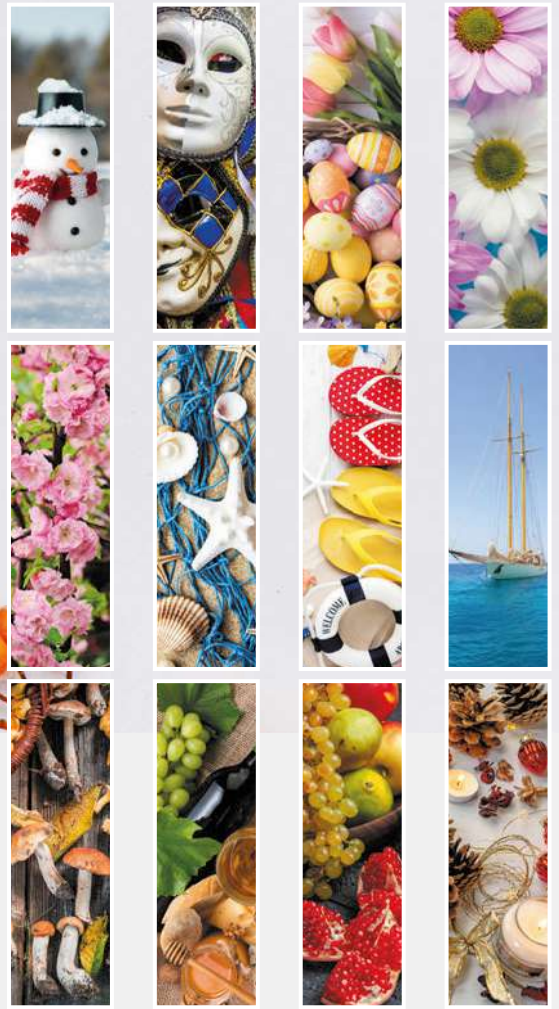

PA115 Quattro stagioni  
Illustrato mensile 12 fogli, carta patinata 70 gr  
testata termosaldata

f.to calendario: 29x47 cm ca  
f.to testata: 29x9 cm ca  
100





# PA117 Mete da sogno



formato 29x47 cm ca

Festività Internazionali

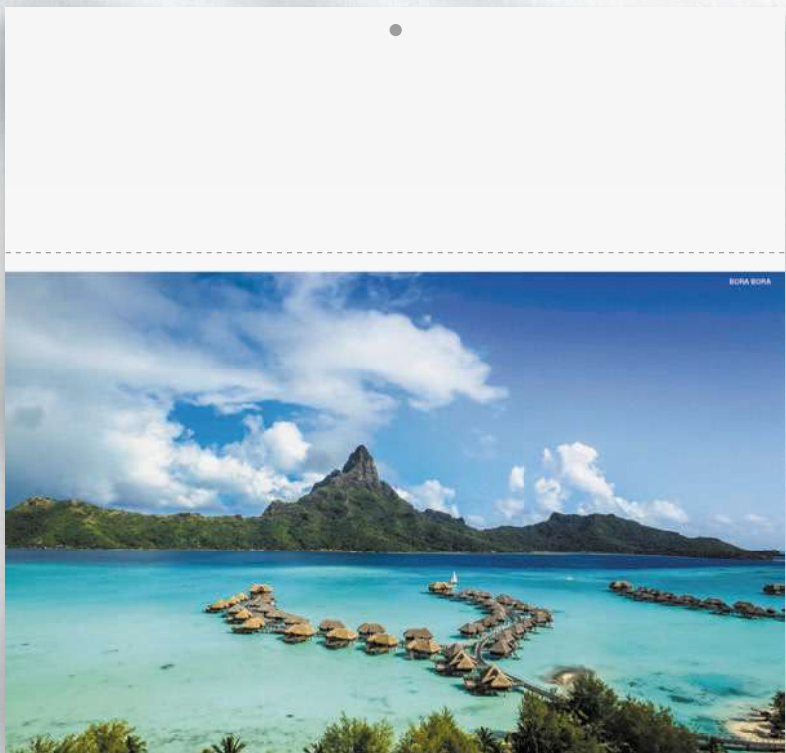

## LO SPETTACOLO DALL'ALTO

Arrivare a Bora Bora è di per sé uno spettacolo visto che il volo permette di vedere all'orizzonte il mare. Omettendo che sorge all'improvviso come un piccolo verde circondato da oceano azzurro. Avvicinandosi più si comincia a scorgere i resort di lusso, con i bungalow dai tetti di paglia e le lunghe passerelle che si estendono sul mare. A differenza di Tahiti e Moorea, la maggior parte dei resort turistici di Bora Bora non si trova sull'isola, ma proprio sul bordo dei piccoli motu che la circondano. Per questo motivo, molto probabilmente viaggerete dall'aeroporto al vostro resort via barca e una barca sarà il mezzo di trasporto con cui vi muoverete più frequente. Per le località situate sull'isola principale, c'è la possibilità di prendere il traghetto per il villaggio portuale di Vaitape, dove il trasporto via terra è disponibile per le singole località. Bora Bora non ha una vera città, ma il suo più grande villaggio e porto principale è Vaitape, che ospita alcune dozzine di negozi e diversi ristoranti e bar sul lungomare. Questo è il luogo giusto per fare scalo e scoprire l'arcipelago che propone, ovviamente, souvenirs esclusivi come le perle nere di Tahiti, gioielli di corallo, perle dai mille colori, sculture in legno e oli profumati. Per scoprire Vaitape è piacevole e sufficiente una breve passeggiata, anche perché è generalmente molto tranquillo soprattutto durante la lunga pausa dei negozi del mezzogiorno. Torna quando le navi da crociera sono in porto.

## IL CLIMA

Il clima di Bora Bora e nelle isole circostanti è tropicale con una stagione umida e una secca. La stagione umida (fastida) va da novembre fino ad aprile e condiziona tre quarti della pioggia dell'anno con un alto tasso di umidità e la temperatura di 30 °C. La stagione secca va da maggio ad ottobre e in questo periodo il turismo è al suo picco nell'isola. Durante questi mesi la temperatura si abbassano di pochi gradi e la pioggia è scarsa, la temperatura dell'acqua è calda. Ma in compenso i prezzi scendono verso l'alto.

## LE TEMPERATURE MEDIE

GEN	FEB	MAR	APR	MAG	GIU	LUG	AUG	SET	OCT	NOV	DIC
28	28	28	28	27	26	25	24	23	22	21	20
21	21	21	21	21	21	21	21	21	21	21	21

## GENNAIO 2024

1	Lunedì	1884
2	Martedì	1885
3	Mercoledì	1886
4	Giovedì	1887
5	Venerdì	1888
6	Sabato	1889
7	Domenica	1890
8	Lunedì	1891
9	Martedì	1892
10	Mercoledì	1893
11	Giovedì	1894
12	Venerdì	1895
13	Sabato	1896
14	Domenica	1897
15	Lunedì	1898
16	Martedì	1899

## FEBBRAIO 2024

1	2	3	4	5	6	7	8	9	10	11	12	13	14	15	16	17	18	19	20	21	22	23	24	25	26	27	28	29	30	31
---	---	---	---	---	---	---	---	---	----	----	----	----	----	----	----	----	----	----	----	----	----	----	----	----	----	----	----	----	----	----

## DICEMBRE 2023

1	2	3	4	5	6	7	8	9	10	11	12	13	14	15	16	17	18	19	20	21	22	23	24	25	26	27	28	29	30	31
---	---	---	---	---	---	---	---	---	----	----	----	----	----	----	----	----	----	----	----	----	----	----	----	----	----	----	----	----	----	----

Capricorno 22/12/24/1

PA117 Mete da sogno  
Illustrato mensile 12 fogli, carta patinata 70 gr  
testata termosaldata



- f.to calendario: 29x47 cm ca
- f.to testata: 29x9 cm ca
- 100



# PA132 Gastronomia

formato  
29x47 cm ca

Festività  
Internazionali

Retrostampato

### Pasta con i tenerumi



**Ingredienti:**  
200 g di spaghetti  
4 pomodori interi  
6-7 rane di tenerumi

**Preparazione:**  
Innaffia e prepara i "picchi tenerumi" in una piccola capriata fusa durante l'impasto, quindi disponila in un contenitore quadrato tagliato a dadini. Mescolate, sigillate di sale e lasciate marinare a lenno basso per 15-20 minuti. Filtrate la salsa di pomodoro. Trasferite la frittura più saporita e mediatamente a sciacquare sotto l'acqua corrente. Lasciate scolare bene e bagnate e struccate su un tagliere. Scolare la pasta e unirla con un sugo di pomodoro. Aggiungete il tenerumi e un cucchiaio di olio d'oliva. Lasciate riposare per 2-3 minuti. In un contenitore capiente portate a ebollizione il brodo di cottura, unite i tenerumi e la pasta e lasciate cuocere per 5-10 minuti. Unite quindi gli spaghetti e cuocerli per il tempo indicato sulla confezione. Scolate parte del brodo di cottura, unite il sugo preparato in precedenza e mescolate bene. Dopo aver fatto riposare il tutto per qualche istante, aggiungete un macinato di pepe, trasferite nei piatti da portata e servite.

### Involtoni di spada



**Ingredienti:**  
8 filetti di pesce spada  
200 g pane raffinato  
1 cucchiaio di cipolla  
prezzemolo qb  
succo di limone qb

**Preparazione:**  
Casciovale sminuzzato  
1 pezzo di origano  
1 spicchio d'aglio  
1 cucchiaio di menta  
1 cucchiaio di cipolla

**Preparazione:**  
Metti in ammollo il pane spezzato. Elimina la pelle dal pesce spada. Batti a filetti e taglialo a metà. Salta le ali da frite. In un tegame scaldato l'olio con la cipolla tritata. Unisci la polpa di pesce spada e cuoci. Scela l'ave pesce e uniscilo al pesce spada insieme al basilico, all'aglio e al prezzemolo tritati. Aggiungi il pane, lo sciroppo di glucosio del limone, 30 g di pangrattato e mescolalo tutto. Guarnisci l'impasto con verdure tritate e il prezzemolo, sale a gusto. Ricorri dai lembi delle mescolate. Prendi le filetti di spada e sminuzza, salate e spezzate. Adagia il centro di ognuno 30 g di ripieno. Chiudi i lati lunghi verso l'interno e sigilla il filetto. Prendi 4 strisci e in un tegame fritto di limone, uno foglio di alloro, un mazzetto, un altro tegame di limone e uno di alloro e cuoci su fiamma alta per 3 minuti su ogni striscia. Unge una tegame da forno, spara gli spaghetti nel pangrattato riduttore per coprirli in maniera uniforme e dilagati sulla tegame ben oliato. Concludi con un olio fto di olio, un pezzo di sale e cuoci in forno statico in modalità grill per circa 10-12 minuti.

### Insalata pantesea



**Ingredienti:**  
5 patate medie  
1 cipolla di Tropeo  
15 pomodori salsicci  
20 g di olive nere

**Preparazione:**  
1 cucchiaio di cipolla  
basilico qb  
origano qb  
1 sacco di aceto di vino

**Preparazione:**  
Per preparare l'insalata pantesea frite per prima cosa lessare le patate che dovranno risultare calde ma ben sode. Lasciate raffreddare, spuntate e tagliate a pezzi. Affettare la cipolla, mettendola in un coltello con fieno e lasciate riposare per uno mezzogiorno. Nel frattempo lavate i pomodori e tagliateli a metà. Trascorso lo mezzogiorno uniscete bene la cipolla e iniziate a comporre il piatto disponendo le patate, i pomodori e la fetta di cipolla. Completate unendo le olive, il basilico e l'origano a piacere. Concludi con un giro d'olio, sale, mescolate e servite l'insalata pantesea.



## La ricetta del mese

### Casearece spada e melanzane

**Ingredienti**  
400 g di casearece, 1 melanzana tonda; 500 g di pesce spada a filetti; 1 bicchiere di vino bianco secco; 2-3 pomodori pelati; menta fresca; olio EVO; sale; pepe.

**Preparazione**  
Cominciate dalle melanzane tagliandole a dadini. Trasferiteli in un piatto, salatele con sale grosso e lasciate riposare per 30 minuti. Nel frattempo tagliate il pesce spada a dadini e rosolatelo in una padella antaderente con olio d'oliva. Sfumatelo con il vino bianco e lasciate evaporare. Aggiungete i pelati tagliati a dadini, salate, spezzate e cuocete per 15 minuti. Unite la riventa spezzettata e lasciate insaporire. Lavate le melanzane per rimuovere il sale, tamponatele con carta da cucina e frigatele in padella con olio d'oliva. Unite le melanzane alla padella con il condimento di pesce spada; aggiungete anche le casearece che avrete lessato e scolato ben al dente, e saltate per qualche istante. Trasferite nei piatti da portata con menta fresca e servite subito.

CAPRICORNO 22/12 - 20/1	
1 LUN	San. 1
2 MAR	11/04
3 MER	11/04
4 GIO	11/04
5 VEN	11/04
6 SAB	11/04
7 DOM	11/04
8 LUN	San. 2
9 MAR	11/04
10 MER	11/04
11 GIO	11/04
12 VEN	11/04
13 SAB	11/04
14 DOM	11/04
15 LUN	San. 3
16 MAR	11/04
17 MER	11/04
18 GIO	11/04
19 VEN	11/04
20 SAB	11/04
21 DOM	11/04
22 LUN	San. 4
23 MAR	11/04
24 MER	11/04
25 GIO	11/04
26 VEN	11/04
27 SAB	11/04
28 DOM	11/04
29 LUN	San. 5
30 MAR	11/04
31 MER	11/04

DICEMBRE 2023		FEBBRAIO 2024		IL SOLE E LA LUNA						
LUN	MAR	MER	GIO	VEN	SAB	DOM	SOLGI TRAMONTA		LUNA	
4	5	6	7	8	9	10	11	12	13	14
11	12	13	14	15	16	17	18	19	20	21
18	19	20	21	22	23	24	25	26	27	28
25	26	27	28	29	30	31	31	32	33	34

PA132 Gastronomia  
Illustrato mensile 12 fogli, carta patinata 70 gr, testata termosaldada

- f.to calendario: 29x47 cm ca
- f.to testata: 29x9 cm ca
- 100



# PA136 Pizza

formato  
29x47 cm ca



Festività Internazionali



## GENNAIO 2024

<b>1 LUN</b> s. Maria Maddalena di Dio - Capodanno	1.546 Sett. 1 0000/0600	<b>CAPRICORNO</b> 22/12 20/1	15.549	<b>MER 17</b> s. Antonio abate
<b>2 MAR</b> s. Basilio e Gregorio	5.364	<b>DICEMBRE 2023</b> L M M G V S D 4 5 6 7 8 9 10 11 12 13 14 15 16 17 18 19 20 21 22 23 24 25 26 27 28 29 30 31	16.548	<b>GIO 18</b> s. Liberato
<b>3 MER</b> s. Gerardo	5.363	<b>FEBBRAIO 2024</b> L M M G V S D 5 6 7 8 9 10 11 12 13 14 15 16 17 18 19 20 21 22 23 24 25 26 27 28 29	19.547	<b>VEN 19</b> s. Marco
<b>4 GIO</b> s. Spirito e Lupo	5.362	<b>2024</b> L M M G V S D 1 2 3 4 5 6 7 8 9 10 11 12 13 14 15 16 17 18 19 20 21 22 23 24 25 26 27 28 29	20.546	<b>SAB 20</b> s. Sebastiano e Procopio
<b>5 VEN</b> s. Antonio	5.361	<b>2024</b> L M M G V S D 1 2 3 4 5 6 7 8 9 10 11 12 13 14 15 16 17 18 19 20 21 22 23 24 25 26 27 28 29	21.545	<b>DOM 21</b> s. Agostino
<b>6 SAB</b> Epifania di N.S.	6.360	<b>2024</b> L M M G V S D 1 2 3 4 5 6 7 8 9 10 11 12 13 14 15 16 17 18 19 20 21 22 23 24 25 26 27 28 29	22.544 Sett. 4	<b>LUN 22</b> s. Vincenz.
<b>7 DOM</b> s. Bartolomeo di Gessi	5.899	<b>2024</b> L M M G V S D 1 2 3 4 5 6 7 8 9 10 11 12 13 14 15 16 17 18 19 20 21 22 23 24 25 26 27 28 29	23.543	<b>MAR 23</b> s. Emerenziana
<b>8 LUN</b> s. Massimo	8.108 Sett. 5	<b>2024</b> L M M G V S D 1 2 3 4 5 6 7 8 9 10 11 12 13 14 15 16 17 18 19 20 21 22 23 24 25 26 27 28 29	24.542	<b>MER 24</b> s. Francesco di Sales
<b>9 MAR</b> s. Giuliano	9.107	<b>2024</b> L M M G V S D 1 2 3 4 5 6 7 8 9 10 11 12 13 14 15 16 17 18 19 20 21 22 23 24 25 26 27 28 29	25.541	<b>GIO 25</b> Conversione di s. Paolo
<b>10 MER</b> s. Albino	10.106	<b>2024</b> L M M G V S D 1 2 3 4 5 6 7 8 9 10 11 12 13 14 15 16 17 18 19 20 21 22 23 24 25 26 27 28 29	26.540	<b>VEN 26</b> s. Teodoro
<b>11 GIO</b> s. Ignazio	11.105	<b>2024</b> L M M G V S D 1 2 3 4 5 6 7 8 9 10 11 12 13 14 15 16 17 18 19 20 21 22 23 24 25 26 27 28 29	27.539	<b>SAB 27</b> s. Agostino Merici
<b>12 VEN</b> s. Clelio	12.104	<b>2024</b> L M M G V S D 1 2 3 4 5 6 7 8 9 10 11 12 13 14 15 16 17 18 19 20 21 22 23 24 25 26 27 28 29	28.538	<b>DOM 28</b> s. Tommaso d'Aquino
<b>13 SAB</b> s. Siro	13.103	<b>2024</b> L M M G V S D 1 2 3 4 5 6 7 8 9 10 11 12 13 14 15 16 17 18 19 20 21 22 23 24 25 26 27 28 29	29.537 Sett. 6	<b>LUN 29</b> s. Costanzo
<b>14 DOM</b> s. Felice	14.102	<b>2024</b> L M M G V S D 1 2 3 4 5 6 7 8 9 10 11 12 13 14 15 16 17 18 19 20 21 22 23 24 25 26 27 28 29	30.536	<b>MAR 30</b> s. Marcellino
<b>15 LUN</b> s. Mauro	15.101 Sett. 7	<b>2024</b> L M M G V S D 1 2 3 4 5 6 7 8 9 10 11 12 13 14 15 16 17 18 19 20 21 22 23 24 25 26 27 28 29	31.535	<b>MER 31</b> s. Costantino
<b>16 MAR</b> s. Marcellino	16.100			

Retrostampato

### IL PIZZAIOLO

Il pizzaiolo è il professionista specializzato nella preparazione della pizza: dalla scelta degli ingredienti fino alla fermentazione e alla cottura in forno. Il pizzaiolo è il protagonista del peccato. La conoscenza della ricetta della pizza contribuisce al momento più delicato del processo in quanto determina direttamente la qualità e la digeribilità della pizza. Per questo motivo il pizzaiolo deve scegliere il tipo di farina adeguato, gestire il dosaggio degli ingredienti (farina, acqua, sale e lievito), la manipolazione e i tempi di fermentazione per ottenere un impasto arioso sponoso e consistente. Una volta pronta l'impasto, bisogna stendere la pizza e farirla: gli ingredienti di base tradizionali possono essere arricchiti con altri tipi di pizza richieste dal cliente, in base alle stagioni e al mercato. Un altro compito molto importante del pizzaiolo è gestire la cottura del pizza in forno: forno a legna, come vuole la tradizione, oppure forno elettrico o a gas, cercando tempi e le temperature per sfornare pizza perfette.



### COME SI DIVENTA PIZZAIOLO

Per fare il pizzaiolo oltre alla passione e alle conoscenze relative a questo mestiere, può essere consigliabile il seguire dei corsi professionali completi ed efficienti, che ti consentano di acquisire la competenza tecnica necessaria alla pratica di questo settore professionale. La maggior parte dei corsi per diventare pizzaiolo sono suddivisi in diversi moduli, per dare la possibilità a tutti di acquisire un livello di competenza avanzata e conoscere ogni dettaglio legato a questo professione. Potrebbe affidarsi alle scuole professionali, che offrono corsi per diventare pizzaiolo dove potrai frequentare le lezioni in aula. Solitamente questi corsi prevedono la presenza di stage obbligatori presso strutture autorizzate. Quindi, seguire un corso ti offre l'opportunità anche di svolgere un tirocinio presso una pizzeria.

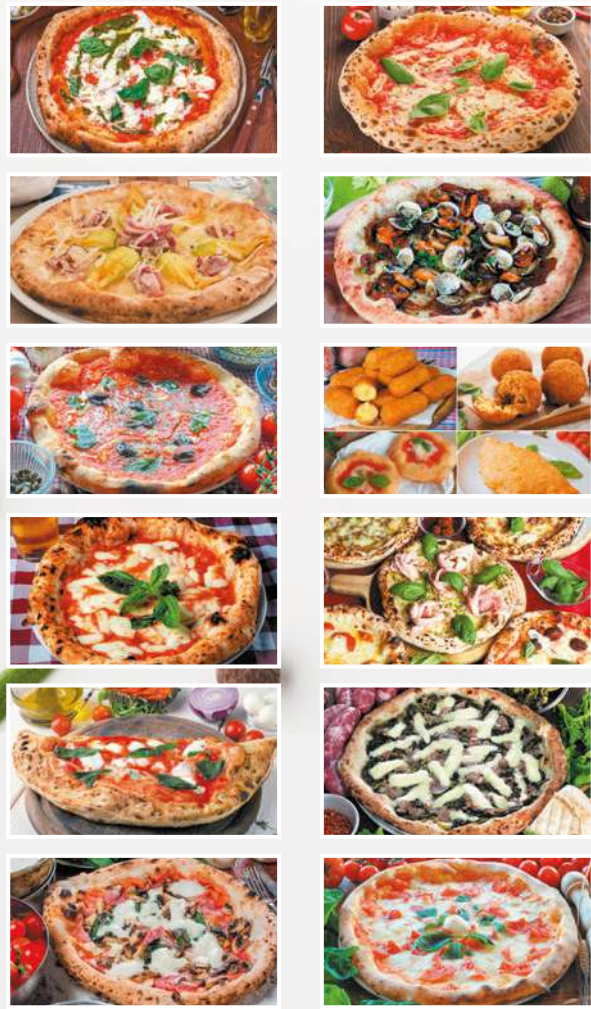

## PA136 Pizza

Illustrato mensile 12 fogli, carta patinata 70 gr testata termosaldata



- f.to calendario: 29x47 cm ca
- f.to testata: 29x9 cm ca
- 100

# PA138 Pane e pasta

formato  
29x47 cm ca

Festività  
Internazionali



<b>1 Lunedì</b> Maria Madre di Dio - Capotona	00:00-01:00 San 1	<b>17 Mercoledì</b> S. Antonio abate	07:00
<b>2 Martedì</b> S. Basilio e Gregorio	5:50	<b>18 Giovedì</b> S. Liberato	08:00
<b>3 Mercoledì</b> S. Genovella	5:50	<b>19 Venerdì</b> S. Maria	09:00
<b>4 Giovedì</b> S. Ernesto e Calisto	5:50	<b>20 Sabato</b> S. Sebastiano e Fabiano	09:50
<b>5 Venerdì</b> S. Felice	5:50	<b>21 Domenica</b> S. Agostino	10:00
<b>6 Sabato</b> Eufemia d.N.S.	6:00 (07:00)	<b>22 Lunedì</b> S. Venceslao	10:00
<b>7 Domenica</b> Battista di Casal	7:00	<b>23 Martedì</b> S. Eusebio	10:00
<b>8 Lunedì</b> S. Massimo	8:00	<b>24 Mercoledì</b> S. Francesco di Sales	10:00
<b>9 Martedì</b> S. Giuliano	9:00	<b>25 Giovedì</b> Comemorazione di S. Paolo	10:00
<b>10 Mercoledì</b> S. Aldo	10:00	<b>26 Venerdì</b> S. Teo e Teodoro	10:00
<b>11 Giovedì</b> S. Ignazio	11:00	<b>27 Sabato</b> S. Angelo Martini	10:00
<b>12 Venerdì</b> S. Cesario	12:00	<b>28 Domenica</b> S. Tommaso d'Aquino	10:00
<b>13 Sabato</b> S. Basilio	13:00	<b>29 Lunedì</b> S. Costantino	10:00
<b>14 Domenica</b> S. Felice	14:00	<b>30 Martedì</b> S. Martina	10:00
<b>15 Lunedì</b> S. Mauro	15:00	<b>31 Mercoledì</b> S. Giovanni Bosco	10:00
<b>16 Martedì</b> S. Marcellino	16:00		

## GENNAIO 2024

DICEMBRE 2023  
L M M G V S D  
1 2 3  
4 5 6 7 8 9 10  
11 12 13 14 15 16 17  
18 19 20 21 22 23 24  
25 26 27 28 29 30 31

Capricorno 12/11 - 20/1

FEBBRAIO 2024  
L M M G V S D  
1 2 3 4  
5 6 7 8 9 10 11  
12 13 14 15 16 17 18  
19 20 21 22 23 24 25  
26 27 28 29

## Retrostampato

### Il pane in Italia: tutti i tipi e le diverse preparazioni

L'importanza del pane nella nostra alimentazione è spesso sottovalutata, ma in realtà questo alimento, prodotto a partire da farine e condimenti importanti. Ma quali sono i tipi di pane più famosi che si preparano in Italia?

**Pane carasau** è un pane tipico sardo, angolare perché la sua forma è di stile molto sarda e sconsigliata, preparato con farina di grano duro, si passa a varie preparazioni e viene fritto, viene anche chiamato come mazzetta per la sua forma triangolare con le pergamene sulle quali il tempo venivano compilate le mazette sacre.

**Pane di Matera** si ottiene da un antico sistema di lavorazione di questo pane che finisce il Regno di Napoli e si commercializza per l'utilizzo esclusivo di semola di grano duro. Ha una forma rotonda che rappresenta un sistema storico di misura di colore grigio e turchese per la sua pasta e per il sapore caratteristico.

**Pane di Altamura** si ottiene da un antico sistema di lavorazione di questo pane che finisce il Regno di Napoli e si commercializza per l'utilizzo esclusivo di semola di grano duro. Ha una forma rotonda che rappresenta un sistema storico di misura di colore grigio e turchese per la sua pasta e per il sapore caratteristico.

### Il pane delle regioni

Abruzzo: Pane Aquilano  
Basilicata: Pane di Lucania  
Calabria: Pane  
Campania: Pane casale  
Emilia Romagna: Cappelletto  
Friuli Venezia Giulia: Biga  
Lazio: Cialotta romana  
Liguria: Capretto  
Lombardia: Mielito  
Marche: Cecco  
Piemonte: Crastin  
Puglia: Pane di Avanzo  
Molise: Pane spigno  
Sardegna: Pane carasau  
Sicilia: Cuccidati e carozza  
Toscana: Marone  
Trentino Alto Adige: Pane di popovino  
Umbria: Ciavolotto  
Valle d'Aosta: Panbarbora  
Veneto: Antongaro



**PA138 Pane e pasta**  
Illustrato mensile 12 fogli, carta patinata 70 gr testata termosaldata



- f.to calendario: 29x47 cm ca
- f.to testata: 29x9 cm ca
- 100

# PA140 Prodotti tipici



formato  
29x47 cm ca

Festività  
Internazionali



### MOZZARELLA DI BUFALA D.O.P.

La Mozzarella di Bufala D.O.P. è un formaggio da tavola di pasta filata, ottenuto da latte intero di bufala, il disciplinare contenuto nel D.P.R. 28/5/1979 prevede, per la produzione della Mozzarella di bufala, in tal modo rimane escluso un impiego anche parziale di latte bovino, ovvero la Mozzarella non potrebbe essere più denominata "di bufala" ed il latte bovino dovrebbe essere necessariamente incluso tra gli ingredienti di produzione. In questo caso, necessariamente, bisogna fare attenzione alla denominazione: solo il prodotto posto in vendita con la dicitura completa "Mozzarella di bufala campana" è quello originale, mentre il prodotto venduto come "Mozzarella di bufala" è prodotto in qualsiasi altro parte d'Italia, con latte di bufala proveniente da allevamenti situati in altre zone all'estero da quella italiana. Il prodotto venduto come "Mozzarella con latte di bufala" è sempre miscelato con latte di mucca in proporzioni variabili. Esiste una legge che vieta la vendita dei latticini, cioè privi dell'intero nocivo la riprova del prodotto, gli ingredienti e l'aspetto produttivo con il relativo indirizzo. Ogni prodotto D.O.P. reca il marchio che ne attesta l'originalità.

**Esame gustativo**  
Le caratteristiche di consistenza vengono integrate durante la maturazione, in questo caso l'aspetto si staglia, presenta attenzione all'elasticità e alla assenza della pasta.

**Elasticità:** la densità persistente durante la maturazione, il latte infuso possiede il composto boccia, ammorbidito con la lingua come il gelato e miscelando il tempo richiesto per rendere la Mozzarella una alta digeribilità.

**Flavour:** il tipo dell'infusione della sensazione gustativa con la presenza olfattiva per via aromatica. La consistenza principale della mozzarella è la freschezza, quindi si debbono privilegiare le note copiose e aromatiche legate al latte e alla sua composizione.

**Gusto:** è il risultato di aromazioni che si evolvono sulla lingua, il dolce viene percepito sulla punta della lingua, il retrogusto amaro, facile in fondo.

<b>1 LUN</b> Mara Macis di Dio - Capodanno	1.385	<b>2024</b>	<b>MER 17</b> s. Antonio abate
<b>2 MAR</b> ss. Basilio e Gregorio	1.384	<b>gen</b>	<b>GIO 18</b> s. Liberata
<b>3 MER</b> s. Gervasio	1.383		<b>VEN 19</b> s. Marco
<b>4 GIO</b> ss. Ermete e Galo	1.382		<b>SAB 20</b> ss. Sebastiano e Feliciano
<b>5 VEN</b> s. Felice	1.381		<b>DOM 21</b> s. Pancrazio
<b>6 SAB</b> Epifania di N.S.	1.380	<b>LUN 22</b> s. Vincenzo	<b>2024</b>
<b>7 DOM</b> Battesimo di Gesù	1.379	<b>MAR 23</b> s. Emmerenziana	
<b>8 LUN</b> s. Massimo	1.378	<b>MER 24</b> s. Francesco di Sales	<b>GIO 25</b> Conversione di s. Paolo
<b>9 MAR</b> s. Giuliano	1.377	<b>VEN 26</b> ss. Tito e Tiziano	<b>VEN 26</b> s. Angelo Merico
<b>10 MER</b> s. Albino	1.376	<b>SAB 27</b> s. Tommaso d'Aquino	<b>DOM 28</b> s. Costanzo
<b>11 GIO</b> s. Agostino	1.375	<b>LUN 29</b> s. Costanzo	<b>MAR 30</b> s. Marcellino
<b>12 VEN</b> s. Cesario	1.374	<b>MAR 30</b> s. Giovanni Battista	<b>19</b>
<b>13 SAB</b> s. Bartolomeo	1.373	<b>18</b>	<b>20</b>
<b>14 DOM</b> s. Felice	1.372	<b>17</b>	<b>21</b>
<b>15 LUN</b> s. Mauro	1.371	<b>16</b>	<b>22</b>
<b>16 MAR</b> s. Marcellino	1.370	<b>15</b>	<b>23</b>
		<b>14</b>	<b>24</b>
		<b>13</b>	<b>25</b>
		<b>12</b>	<b>26</b>
		<b>11</b>	<b>27</b>
		<b>10</b>	<b>28</b>
		<b>9</b>	<b>29</b>
		<b>8</b>	<b>30</b>
		<b>7</b>	<b>31</b>
		<b>6</b>	
		<b>5</b>	
		<b>4</b>	
		<b>3</b>	
		<b>2</b>	
		<b>1</b>	



**PA140** Prodotti tipici  
Illustrato mensile 12 fogli, carta patinata 70 gr  
testata termosaldata

QR code  
f.to calendario: 29x47 cm ca  
f.to testata: 29x9 cm ca  
100







# PA146 Frutta e verdura



formato  
29x47 cm ca

Festività  
Internazionali

## GENNAIO 2024

<b>1 LUN</b> s. Maria Maddalena e Dio - Capodanno	1549	<b>17 MER</b> s. Antonio abate
<b>2 MAR</b> s. Basilio e Gregorio	1548	<b>18 GIO</b> s. Liberato
<b>3 MER</b> s. Gerardo	1547	<b>19 VEN</b> s. Marco
<b>4 GIO</b> s. Dionigi e Lupo	2048	<b>20 SAB</b> s. Sebastiano e Procopio
<b>5 VEN</b> s. Anacleto	2045	<b>21 DOM</b> s. Agostino
<b>6 SAB</b> Epifania e S.S.	2244	<b>22 LUN</b> s. Vincenz.
<b>7 DOM</b> Gartemiro di Giesi	2343	<b>23 MAR</b> s. Emerenziana
<b>8 LUN</b> s. Massimo	2440	<b>24 MER</b> s. Francesco di Sales
<b>9 MAR</b> s. Giuliano	2639	<b>25 GIO</b> Conversione di s. Paolo
<b>10 MER</b> s. Clelio	2638	<b>26 VEN</b> s. Trifone
<b>11 GIO</b> s. Ignazio	2739	<b>27 SAB</b> s. Angelo Merici
<b>12 VEN</b> s. Cesario	2838	<b>28 DOM</b> s. Tommaso d'Aquino
<b>13 SAB</b> s. Siro	2937	<b>29 LUN</b> s. Costanzo
<b>14 DOM</b> s. Felice	3036	<b>30 MAR</b> s. Martina
<b>15 LUN</b> s. Agostino	3135	<b>31 MER</b> s. Cleofe e Sacco
<b>16 MAR</b> s. Marcellino		

**CALENDARIO DI SANTE**  
 1. L. 12/12/2011  
 2. L. 12/12/2011  
 3. L. 12/12/2011  
 4. L. 12/12/2011  
 5. L. 12/12/2011  
 6. L. 12/12/2011  
 7. L. 12/12/2011  
 8. L. 12/12/2011  
 9. L. 12/12/2011  
 10. L. 12/12/2011  
 11. L. 12/12/2011  
 12. L. 12/12/2011  
 13. L. 12/12/2011  
 14. L. 12/12/2011  
 15. L. 12/12/2011  
 16. L. 12/12/2011  
 17. L. 12/12/2011  
 18. L. 12/12/2011  
 19. L. 12/12/2011  
 20. L. 12/12/2011  
 21. L. 12/12/2011  
 22. L. 12/12/2011  
 23. L. 12/12/2011  
 24. L. 12/12/2011  
 25. L. 12/12/2011  
 26. L. 12/12/2011  
 27. L. 12/12/2011  
 28. L. 12/12/2011  
 29. L. 12/12/2011  
 30. L. 12/12/2011  
 31. L. 12/12/2011

## FRUTTA DI STAGIONE

Mangiare frutta di stagione, così come verdure di stagione, è il miglior modo per fare il pieno di energia e vitamine. Assorbendo il giusto nutrimento, il corpo si rigenera e si prepara per affrontare la stagione invernale. La frutta di stagione è quella che si è formata in natura nel periodo giusto, in un luogo e in un momento precisi. Il frutto è sano e nutriente perché ha un sapore dolce e un profumo intenso. Assorbirlo ci dà energia e ci aiuta a digerire. La frutta di stagione è quella che si è formata in natura nel periodo giusto, in un luogo e in un momento precisi. Il frutto è sano e nutriente perché ha un sapore dolce e un profumo intenso. Assorbirlo ci dà energia e ci aiuta a digerire.

**La frutta in base alle stagioni**

**Estate**  
 anguria, melone, pompelmo, melancia, pera, fico, kiwi, mandarino, albicocca, melo, mela, nashi, sennepino, susino giapponese, uva, lamparina.

**Primavera**  
 fragola, carota dolce, kiwi, melo, mela verde.

**Estate**  
 albicocca, melone, fico, ciliegia, pesche, susino, tutte le varietà di anguria, melo, mela, mela verde, mela, mela verde, mela, mela verde, mela, mela verde.

**Autunno**  
 pera, melancia, mela, mela verde, mela, mela verde, mela, mela verde, mela, mela verde.

Alcune varietà di frutta commestibile sono disponibili in tutti i mesi dell'anno. Tuttavia, la frutta di stagione è quella che si è formata in natura nel periodo giusto, in un luogo e in un momento precisi. Il frutto è sano e nutriente perché ha un sapore dolce e un profumo intenso. Assorbirlo ci dà energia e ci aiuta a digerire.



**PA146 Frutta e verdura**  
Illustrato mensile 12 fogli, carta patinata 70 gr testata termosaldata

f.to calendario: 29x47 cm ca  
f.to testata: 29x9 cm ca  
100

# PA148 Dolci momenti



formato 29x47 cm ca

Festività Internazionali

Retrostampato

**LA BEVANDA PIÙ CONSUMATA AL MONDO: IL CAFFÈ**

Il caffè è una delle bevande più consumate al mondo, oltre che ricca di benefici. Il caffè nero è anche un bevanda che offre diversi benefici all'organismo. I benefici del caffè sono noti e anche scientificamente provati, per questo motivo il suo consumo (o almeno che non siano presenti specifiche controindicazioni) è consigliato. Tra i tre benefici principali ci sono:

1. L'effetto tonico e stimolante: agisce sul sistema nervoso centrale, agendo sulla secrezione di adrenalina, che agisce sulla gastrica. Ecco perché si può suggerire il consumo di caffè alla fine di un pasto al fine di agevolare il processo di digestione. L'effetto stimolante è dovuto, in parte, anche alla funzione di un nervoso sia cardiaco.
2. Effetto ipotensivo: il caffè e il caffè in polvere innescano un effetto che favorisce il rilassamento. La caffeina, infatti, riesce a stimolare il modo adeguato l'uso dei grassi corporei al fine di innescare il processo di termogenesi per aumentare l'energia dell'organismo. Quindi grazie a questo effetto è possibile aumentare la quantità di calorie bruciate.
3. Migliora la salute di benessere: un consumo adeguato di caffè permette di assorbire grandi dosi di vitamine e i sali minerali in esso contenuti. Nello specifico, il caffè contiene la vitamina B2 che agisce sui processi metabolici, migliora il tessuto nervoso e lo stato della pelle. La vitamina B3 è invece essenziale per il funzionamento del sistema nervoso.

**QUANTI CAFFÈ BERE AL GIORNO?**

Le linee guida che vengono di solito indicate da parte dei medici e delle organizzazioni che si occupano della salute umana indicano che questo non bisogna eccedere nel consumo di caffè. Secondo queste linee guida, sulla base di un consumo massimo di 400 mg di caffeina, un consumo massimo di 2-3 tazzine di caffè per buona parte delle persone. Ma quanti caffè sono troppi al giorno? Considerando che una tazzina di caffè contiene circa 80 mg di caffeina, in teoria si possono bere cinque caffè al giorno.

## GENNAIO 2024

CAPRICORNO 22/12 - 20/1

1 LUN	San Valentino	14/01
2 MAR	San Valentino	14/01
3 MER	San Valentino	14/01
4 GIO	San Valentino	14/01
5 VEN	San Valentino	14/01
6 SAB	San Valentino	14/01
7 DOM	San Valentino	14/01
8 LUN	San Valentino	14/01
9 MAR	San Valentino	14/01
10 MER	San Valentino	14/01
11 GIO	San Valentino	14/01
12 VEN	San Valentino	14/01
13 SAB	San Valentino	14/01
14 DOM	San Valentino	14/01
15 LUN	San Valentino	14/01
16 MAR	San Valentino	14/01
17 MER	San Valentino	14/01
18 GIO	San Valentino	14/01
19 VEN	San Valentino	14/01
20 SAB	San Valentino	14/01
21 DOM	San Valentino	14/01
22 LUN	San Valentino	14/01
23 MAR	San Valentino	14/01
24 MER	San Valentino	14/01
25 GIO	San Valentino	14/01
26 VEN	San Valentino	14/01
27 SAB	San Valentino	14/01
28 DOM	San Valentino	14/01
29 LUN	San Valentino	14/01
30 MAR	San Valentino	14/01
31 MER	San Valentino	14/01

IL SOLE E LA LUNA

SOLE TRAMONTO: 16:50 - 17:00

LUNA: 18:00 - 19:00

SOLE TRAMONTO: 16:50 - 17:00

LUNA: 18:00 - 19:00



**PA148 Dolci momenti**  
 Illustrato mensile 12 fogli, carta patinata 70 gr  
 testata termosaldata



f.to calendario: 29x47 cm ca  
 f.to testata: 29x9 cm ca  
 100

# PA152 Lunario

formato  
29x47 cm ca



Festività  
Internazionali

Retrostampato

## Gennaio



<b>1</b> Lunedì 11.01 Mater Madre di Dio - Capodanno		<b>17</b> Mercoledì 10.01 s. Antonio abate	
<b>2</b> Martedì 12.01 s. Basilio e Gregorio		<b>18</b> Giovedì 11.01 s. Liberata	
<b>3</b> Mercoledì 13.01 s. Genoveffa		<b>19</b> Venerdì 12.01 s. Maso	
<b>4</b> Giovedì 14.01 s. Ermato e Caio		<b>20</b> Sabato 13.01 s. Sebastiano e Fabiano	
<b>5</b> Venerdì 15.01 s. Anselmo		<b>21</b> Domenica 14.01 s. Agnese	
<b>6</b> Sabato 16.01 Epifania d.N.S.		<b>22</b> Lunedì 15.01 s. Vincenzio	
<b>7</b> Domenica 17.01 Battesimo di Gesù		<b>23</b> Martedì 16.01 s. Eusebio	
<b>8</b> Lunedì 18.01 s. Massimo		<b>24</b> Mercoledì 17.01 s. Francesco di Sales	
<b>9</b> Martedì 19.01 s. Gavino		<b>25</b> Giovedì 18.01 Conversione di s. Paolo	
<b>10</b> Mercoledì 20.01 s. Albo		<b>26</b> Venerdì 19.01 s. Teo e Teodoro	
<b>11</b> Giovedì 21.01 s. Igino		<b>27</b> Sabato 20.01 s. Angela Merici	
<b>12</b> Venerdì 22.01 s. Cesario		<b>28</b> Domenica 21.01 s. Tommaso d'Aquino	
<b>13</b> Sabato 23.01 s. Basilio		<b>29</b> Lunedì 22.01 s. Costantino	
<b>14</b> Domenica 24.01 s. Felice		<b>30</b> Martedì 23.01 s. Martina	
<b>15</b> Lunedì 25.01 s. Massimo		<b>31</b> Mercoledì 24.01 s. Ciriacano Biondi	
<b>16</b> Martedì 26.01 s. Marcello			

**LUNA IN CAPRICORNO**  
(dal 22 Dicembre al 20 Gennaio)

I nati con la Luna in Capricorno sono caratterizzati da una mente razionale, poco incline all'astrazione. In entrambi i sessi è molto importante l'autonomia affettiva e finanziaria, forte è il senso della disciplina e del dovere. Chi ha la Luna in Capricorno tende a essere premuroso verso i propri cari. Nascono con una fermezza e vulnerabilità di fondo che si manifesta quando sono in causa i sentimenti più profondi.

**SEMINE E RACCOLTI**

In questo mese dell'anno le temperature sono proibitive ma se il terreno non è troppo gelato è possibile procedere alla semina o al trapianto di numerose piante: peperoni, pomodori, melanzane, rucola, basilico, fave, piselli e carote. Per quanto riguarda, invece, il raccolto, gennaio è il mese giusto per la raccolta dei cavoli e delle bietole, del sedano e del radicchio, dei ravanelli e degli spinaci. Ma è innanzitutto il mese nel quale potete divertirvi, se avete qualche albero da frutta, mele, arance e mandarini. E alcune preziose erbe aromatiche, che appunto si raccolgono proprio a gennaio: rosmarino, salvia, alloro, origano e timo.

**LA SOLE**    **ORIS**    **TRANSITI**    **LA LUNA**

1.01    11.01    11.01    11.01

2.01    12.01    12.01    12.01

3.01    13.01    13.01    13.01

4.01    14.01    14.01    14.01

5.01    15.01    15.01    15.01

6.01    16.01    16.01    16.01

7.01    17.01    17.01    17.01

8.01    18.01    18.01    18.01

9.01    19.01    19.01    19.01

10.01    20.01    20.01    20.01

11.01    21.01    21.01    21.01

12.01    22.01    22.01    22.01

13.01    23.01    23.01    23.01

14.01    24.01    24.01    24.01

15.01    25.01    25.01    25.01

16.01    26.01    26.01    26.01

17.01    27.01    27.01    27.01

18.01    28.01    28.01    28.01

19.01    29.01    29.01    29.01

20.01    30.01    30.01    30.01

21.01    31.01    31.01    31.01

**2024**

Dicembre 2023							Febbraio 2024						
Lunedì	Martedì	Mercoledì	Giovedì	Venerdì	Sabato	Domenica	Lunedì	Martedì	Mercoledì	Giovedì	Venerdì	Sabato	Domenica
4	5	6	7	8	9	10	5	6	7	8	9	10	11
11	12	13	14	15	16	17	12	13	14	15	16	17	18
18	19	20	21	22	23	24	19	20	21	22	23	24	25
25	26	27	28	29	30	31	26	27	28	29			



### INFLUSSO DELLA LUNA SULLE SEMINE

Secondo le tradizioni popolari, per favorire la germinazione delle sementi, bisogna scegliere la luna nuova, per esempio, se dobbiamo seminare una determinata pianta di frutto, come il pomodoro, dobbiamo farlo con la luna piena, mentre fave, piselli, longie e zucca o fagioli sono seminate a seminare con la luna calante. Non solo, sarebbero opportuni ai mediastri infusi, che si preparano, anche in acqua, la menta, il fagiolo degli ocelli, l'impollinamento del seme, ecc. Trattare l'acqua di questa consistenza potrebbe veramente offrire aiuto che non è molto lontano il tempo, in Egitto e in Mesopotamia, dove altre culture, come l'antico Egitto, hanno seminato, pensando che la luna influenzava la fertilità del terreno.



### LUNA CALANTE

Con la luna calante in semina si dovrebbe eguagliare, fave, piselli, zucca, melanzane, rucola, basilico, piselli, cipolle, fagioli, aragoste, salsicce, e coltivate l'acqua possibilmente filtrata e depurata. La luna calante, nell'agricoltura, favorisce, sono fondamentali. Con la luna calante di coltura, non basta porre di seme con la luna calante e la luna crescente, per esempio, il primo mese per seminare il grano, il secondo giorno prima della luna piena e il primo giorno dopo il plenilunio sono un'ottima guida nella coltivazione delle piante della Luna Calante.



### LUNA CRESCENTE

Con la luna crescente o crescente alla semina di diverse ortaggi e piante, tra le più comuni, pomodoro, peperoni, melanzane, zucca, melanzane, fave, piselli, fagioli, ecc. La luna crescente, infatti, favorisce la crescita delle piante, e si dovrebbe effettuare con la luna crescente, anche se, si dovrebbe innanzi a altri tipi di propagazione, si possono colture, ortici e rose, si raccoglie in frutta.

<p><b>LUNARE</b></p>  <p><b>LUNA IN CAPRICORNO</b> (dal 22 Dicembre al 20 Gennaio)</p> <p><b>SEMINE E RACCOLTI</b></p>	<p><b>LUNARE</b></p>  <p><b>LUNA IN AQUARIO</b> (dal 21 Gennaio al 19 Febbraio)</p> <p><b>SEMINE E RACCOLTI</b></p>	<p><b>LUNARE</b></p>  <p><b>LUNA IN PESCI</b> (dal 20 Febbraio al 20 Marzo)</p> <p><b>SEMINE E RACCOLTI</b></p>	<p><b>LUNARE</b></p>  <p><b>LUNA IN ARBURI</b> (dal 21 Marzo al 20 Aprile)</p> <p><b>SEMINE E RACCOLTI</b></p>
<p><b>LUNARE</b></p>  <p><b>LUNA IN TORO</b> (dal 21 Aprile al 20 Maggio)</p> <p><b>SEMINE E RACCOLTI</b></p>	<p><b>LUNARE</b></p>  <p><b>LUNA IN GEMELLI</b> (dal 21 Maggio al 20 Giugno)</p> <p><b>SEMINE E RACCOLTI</b></p>	<p><b>LUNARE</b></p>  <p><b>LUNA IN CANCRO</b> (dal 21 Giugno al 20 Luglio)</p> <p><b>SEMINE E RACCOLTI</b></p>	<p><b>LUNARE</b></p>  <p><b>LUNA IN LEONE</b> (dal 21 Luglio al 19 Agosto)</p> <p><b>SEMINE E RACCOLTI</b></p>
<p><b>LUNARE</b></p>  <p><b>LUNA IN VERGINE</b> (dal 20 Agosto al 19 Settembre)</p> <p><b>SEMINE E RACCOLTI</b></p>	<p><b>LUNARE</b></p>  <p><b>LUNA IN BILANCIA</b> (dal 20 Settembre al 19 Ottobre)</p> <p><b>SEMINE E RACCOLTI</b></p>	<p><b>LUNARE</b></p>  <p><b>LUNA IN SCORPIONE</b> (dal 20 Ottobre al 19 Novembre)</p> <p><b>SEMINE E RACCOLTI</b></p>	<p><b>LUNARE</b></p>  <p><b>LUNA IN SAGITTARIO</b> (dal 20 Novembre al 19 Dicembre)</p> <p><b>SEMINE E RACCOLTI</b></p>

PA152 Lunario  
Illustrato mensile 12 fogli, carta patinata 70 gr  
testata termosaldata



f.to calendario: 29x47 cm ca  
f.to testata: 29x9 cm ca  
100

# PA154 Farmacia

formato 29x47 cm ca



Festività Internazionali

## GENNAIO

Il Calendario del Farmacista

**1 Lunedì** 1-365  
Maria Madre di Dio - Capodanno

**2 Martedì** 2-364  
s. Basilio e Gregorio

**3 Mercoledì** 3-363  
s. Genoveffa

**4 Giovedì** 4-362  
s. Ermete e Cato

**5 Venerdì** 5-361  
s. Arnella

**6 Sabato** 6-360  
Epifania di N.S.

**7 Domenica** 7-359  
Battesimo di Gesù

**8 Lunedì** 8-366  
s. Massimo

**9 Martedì** 9-367  
s. Giuliano

**10 Mercoledì** 10-366  
s. Aldo

**11 Giovedì** 11-365  
s. Igino

**12 Venerdì** 12-364  
s. Costia

**13 Sabato** 13-363  
s. Felice

**14 Domenica** 14-362  
s. Felice

**15 Lunedì** 15-361  
s. Meuro

**16 Martedì** 16-360  
s. Marcello

**SERVIZI OFFERTI DALLA FARMACIA**

Il farmacista al giorno d'oggi non distribuisce più solo il farmaco, ma fornisce e offre servizi innovativi e consulenze al cliente finale. L'offerta di servizi dal rapporto acceso e dalla qualità riconosciuta, in termini di prevenzione e di monitoraggio della patologia si traduce in un'importante leva competitiva per la farmacia. Per dare un'idea di quello che la farmacia che servizi è in grado di offrire oggi, ve ne presentiamo alcuni:

**FARMACOVIGILANZA** è un sistema che raccoglie tutte le informazioni che emergono sui reazioni sospette dal farmaco per cercare di stabilire quali sono i guasti rapporti di causa-effetto e il rischio benefico.

**PRESTAZIONI PROFESSIONALI:** la farmacia può effettuare il servizio di assistenza integrata a favore dei clienti, mettendo a disposizione operatori socio-sanitari come infermieri e fisioterapisti per eseguire specifiche attività professionali.

**CONTROLLO DEL PESO:** tenere il peso sotto controllo diventa importante per tutta quelle persone che sono affette anche da altri disturbi quali diabete o ipertensione ed avere il colesterolo alto, quindi è importante tenerne sotto controllo il proprio peso con un controllo periodico, con l'aiuto e con il consiglio che il farmacista può offrire, per evitare problemi.

**17 Mercoledì** 17-349  
s. Antonio abate

**18 Giovedì** 18-348  
s. Liberata

**19 Venerdì** 19-347  
s. Mario

**20 Sabato** 20-346  
ss. Sebastiano e Fabiano

**21 Domenica** 21-345  
s. Agnese

**22 Lunedì** 22-344  
s. Vincenzo

**23 Martedì** 23-343  
s. Emerenziana

**24 Mercoledì** 24-342  
s. Francesco di Sales

**25 Giovedì** 25-341  
Conversione di s. Paolo

**26 Venerdì** 26-340  
ss. Tito e Timoteo

**27 Sabato** 27-339  
s. Angela Merici

**28 Domenica** 28-338  
s. Tommaso d'Aquino

**29 Lunedì** 29-337  
s. Costanzo

**30 Martedì** 30-336  
s. Martina

**31 Mercoledì** 31-335  
s. Oliviero di Bozou

**IL SOLE** **BOZZE** **TRAMONTO** **LA LUNA**  
 1 giorno 1 ore 23' ore 16:52 21:28 giorno 4 ore 4:50  
 10 12 ore 22' ore 16:51 21:27 giorno 11 ore 10:27  
 20 14 ore 13' ore 16:50 21:26 giorno 18 ore 10:27  
 30 15 ore 1' ore 16:49 21:25 giorno 25 ore 10:27

**Nota:** la prima ora tramonta dal sole prima del tramonto e la seconda, sempre prima della luna.

**DICEMBRE 2023**

Lunedì	Martedì	Mercoledì	Giovedì	Venerdì	Sabato	Domenica
4	5	6	7	8	9	10
11	12	13	14	15	16	17
18	19	20	21	22	23	24
25	26	27	28	29	30	31

# 2024

**FEBBRAIO 2024**

Lunedì	Martedì	Mercoledì	Giovedì	Venerdì	Sabato	Domenica
5	6	7	8	9	10	11
12	13	14	15	16	17	18
19	20	21	22	23	24	25
26	27	28	29			

L'IMPOSTA DI PUBBLICITÀ, NEL RISPETTO DEL BUDGET AMBITO LOCALE È A CARICO DI CHI LO SPONDE IN PUBBLICITÀ

**SERVIZI OFFERTI DALLA FARMACIA**

**FARMACOVIGILANZA**

**PRESTAZIONI PROFESSIONALI**

**CONTROLLO DEL PESO**

**QUALI SONO LE CAUSE DELL'ACNE?**

**LE DIVERSE TIPOLOGIE DI ACNE**

**LE CAUSE DELL'ANSIA FISIOLOGICA O PATOLOGICA?**

**QUALI SONO LE CAUSE DELL'ANSIA?**

**IL SOLE**

**I REMEDI PIU' EFFICACI**

**DIFFERENTI FORME DI CEFALEE**

**QUALI SONO LE TERAPIE PREVISTE?**

**TEST E GESTIONE DELLE ALLERGIE**

**QUALI SONO I TIPI DI CISTITE?**

**COME PREVENIRE LA CISTITE?**

**LA PEDILOSITÀ DEL CAPO**

**GLI INTEGRATORI ALIMENTARI**

**INTEGRATORI: COMPOSIZIONE**

**COME DIAGNOSTICARLA**

**IL CICORSO AGLI ANTIPIRETICI**

**IL USO DEGLI ANTINFIAMMATORI**

**QUALI SONO LE CAUSE DELL'ANSIA?**

**QUALI SONO LE CAUSE DELL'ANSIA?**

**IL SOLE**

**I REMEDI PIU' EFFICACI**

**DIFFERENTI FORME DI CEFALEE**

**QUALI SONO LE TERAPIE PREVISTE?**

## PA154 Farmacia

Illustrato mensile 12 fogli, carta patinata 70 gr testata termosaldada



f.to calendario: 29x47 cm ca

f.to testata: 29x9 cm ca

100

**Il calendario del farmacista**

# I SERVIZI OFFERTI DALLA FARMACIA

La farmacia oggi non è più, solamente, il luogo della dispensazione dei farmaci, ma rappresenta un punto di riferimento fondamentale per il benessere del cittadino, attraverso l'offerta di servizi, consigli, informazioni e prestazioni diagnostiche che trasformano la farmacia stessa in un centro capace di dispensare "salute" nel senso più ampio della parola.

## IN FARMACIA SI POSSONO FARE ANCHE LE ANALISI

Tra le analisi di primo livello rientrano: la misurazione della glicemia; la misurazione dei livelli di trigliceridi e di colesterolo; la misurazione in tempo reale di creatinina, transaminasi, emoglobina glicata ed ematocrito; i test di gravidanza; i test di ovulazione e i test di menopausa per la misura dei livelli dell'ormone FSH presenti nella urine; i test del coloreto, che sono effettuati attraverso l'analisi del sangue raccolto nelle feci; le analisi per la misurazione dei componenti nelle urine, come proteine ed esteri leucocitari, nitriti, pH, sangue, acido ossalico, leucociti, chetoni, urobilinoogeno e bilirubina... Tra i test diagnostici, e le analisi di secondo livello rientrano: la misurazione della pressione arteriosa con l'uso di strumenti non invasivi; l'auto-spirometria per la misurazione della capacità polmonare; l'analisi della saturazione percentuale dell'ossigeno attraverso l'uso di tecniche non invasive; il monitoraggio, attraverso pratiche non invasive, dell'attività cardiaca e della pressione arteriosa, in collegamento con centri di cardiologia accreditati dalle Regioni sulla base di specifici requisiti tecnici, professionali e strutturali; l'effettuazione di elettrocardiogrammi attraverso modalità di tele cardiologia, effettuati mediante un collegamento con centri di cardiologia accreditati dalle Regioni, sulla base di specifici requisiti tecnici, professionali e strutturali.

## PRENOTAZIONE DELLE PRESTAZIONI SPECIALISTICHE

Con il Decreto dell'8 luglio 2011 la farmacia, attraverso una postazione dedicata, possono operare anche come canali di accesso al Sistema CLUP per prenotare prestazioni di assistenza specialistica ambulatoriale presso le strutture sanitarie pubbliche e private accreditate, provvedere al pagamento dei ticket.

## L'INFERMIERE IN FARMACIA

L'infermiere in farmacia può provvedere alla corretta applicazione delle prescrizioni diagnostiche-terapeutiche, offrire supporto alla determinazione, prescrizione di generi sottoposti a riserchio nell'ambito dell'autocontrollo, effettuare medicazioni e di cura iniettiva intramuscolare, svolgere attività concernenti l'educazione sanitaria e la partecipazione a programmi di counseling, anche personalizzati, portatore ad iniziative finalizzate a favorire l'aderenza dei malati alle terapie. L'infermiere può inoltre, su prescrizione dei medici di medicina generale e dei medici di libera scelta, erogare sia all'interno della farmacia, sia a domicilio del paziente, ulteriori prestazioni rientranti fra quelle attribuite al suo autonomo e proprio profilo professionale.

# I SERVIZI OFFERTI DALLA FARMACIA

## IN FARMACIA SI POSSONO FARE ANCHE LE ANALISI

## PRENOTAZIONE DELLE PRESTAZIONI SPECIALISTICHE

## L'INFERMIERE IN FARMACIA

# ACNE, GOSI, RIMEDI E COME CURARLA

## IL TRATTAMENTO

## DEINCRARE PER IL VISO

## SPREMIERE I BRUFOLI

## ACNE E ALIMENTAZIONE

# COS'È L'ALLERGIA?

## COSA ACCADE NEI SOGGETTI ALLERGICI?

## I FARMACI IMPIEGATI

## LE ALLERGIE PIÙ DIFFUSE

# LE CAUSE DEL SONNO DISTURBATO

## INTEGRATORI PER DORMIRE

## RIMEDI PER CONTRASTARE IL SONNO DISTURBATO

## SONNO E ALIMENTAZIONE

# ANSIA E DISTURBI D'ANSIA

## SINTOMI DELL'ANSIA

## I DISTURBI D'ANSIA

## TERAPIA FARMACOLOGICA

## PSICOTERAPIA PER L'ANSIA

# COSA CONTENGONO GLI INTEGRATORI ALIMENTARI?

## GLI EFFETTI BENEFICI DEI MULTIVITAMINICI

## VITAMINE LIPOSOLUBILI

## VITAMINE IDROSOLUBILI

# QUANTO È COMUNE LA CISTITE?

## QUALI SONO I SINTOMI DELLA CISTITE?

## LA CISTITE CRONICA

## LE CISTITE ACUTA

# COSA ACCADE ALLA PELLE IN ESTATE?

## DUE MOSSE PER UNA PELLE SANA ANCHE IN ESTATE

## PRONIA D'ORFOME (DORFOMI)

## QUANDO APPLICARE I SOLARI

# COME ACCORGERSI DEI PIDOCCHI

## IL TRATTAMENTO

## COSA SONO I PIDOCCHI?

## COME SI TRASMETTONO?

## I SINTOMI TIPICI

# PANORAMICA SULLE CEFALEE

## LE PRINCIPALI CEFALEE

## EMICRANIA CON E SENZA AURA

## CEFALIA DI TIPO INTENSIVO

## CEFALIA A GRAPPOLLO

# DIAGNOSTICARE IL MAL DI SCHIENA

## MAL DI SCHIENA INFIAMMATOIO

## COME TRATTARE IL MAL DI SCHIENA

## MAL DI SCHIENA MECCANICO

# LA FARMACOLOGIA

## CLASSIFICAZIONE DEI FARMACI

## MEDICINALI SENZA OBBIETTO DI RICETTA

## MEDICINALI SOGGETTI A PRESCRIZIONE MEDICA

# PA160 Nudo lato B



formato  
29x47 cm ca

Festività  
Internazionali

GENNAIO

&

2024





♈  
CAPRICORNO  
2012  
2011

01 LUNEDI	02 MARTEDI	03 MERCOLEDI	04 GIOVEDI	05 VENERDI	06 SABATO
07 DOMENICA	08 LUNEDI	09 MARTEDI	10 MERCOLEDI	11 GIOVEDI	12 VENERDI
13 SABATO	14 DOMENICA	15 LUNEDI	16 MARTEDI	17 MERCOLEDI	18 GIOVEDI
19 VENERDI	20 SABATO	21 DOMENICA	22 LUNEDI	23 MARTEDI	24 MERCOLEDI
25 GIOVEDI	26 VENERDI	27 SABATO	28 DOMENICA	29 LUNEDI	30 MARTEDI
31 MERCOLEDI					



## PA160 Nudo lato B

Illustrato mensile 12 fogli, carta patinata 70 gr testata termosaldata



f.to calendario: 29x47 cm ca

f.to testata: 29x9 cm ca

100



# PA162 Auto sportive

formato  
29x47 cm ca

Festività  
Internazionali

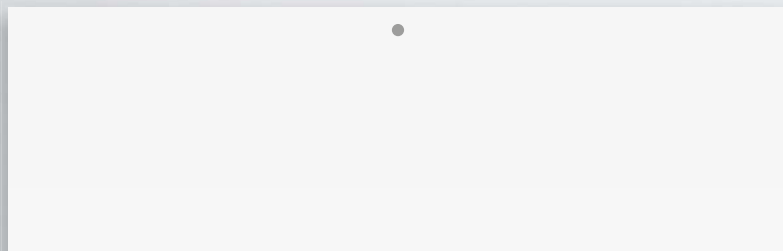

<b>1 LUN</b> s. Maria Maddalena di Dio - Capodanno	1380	<b>17 MER</b> s. Antonio abate	17340
<b>2 MAR</b> s. Basilio e Gregorio	2384	<b>18 GIO</b> s. Livata	18380
<b>3 MER</b> s. Sordani	3388	<b>19 VEN</b> s. Marco	19387
<b>4 GIO</b> s. Emidio e Calisto	4392	<b>20 SAB</b> s. Sebastiano e Fabiano	20390
<b>5 VEN</b> s. Amelia	5396	<b>21 DOM</b> s. Agnese	21393
<b>6 SAB</b> Epifania di N.S.	6399	<b>22 LUN</b> s. Vincenz.	22394
<b>7 DOM</b> Battesimo di Gesù	7403	<b>23 MAR</b> s. Emmanuela	23395
<b>8 LUN</b> s. Massimo	8406	<b>24 MER</b> s. Francesco di Sales	24396
<b>9 MAR</b> s. Giuliano	9407	<b>25 GIO</b> Conversione di s. Paolo	25397
<b>10 MER</b> s. Aiko	10398	<b>26 VEN</b> s. Tito e Timoteo	26398
<b>11 GIO</b> s. Agno	11399	<b>27 SAB</b> s. Agostino Maria	27399
<b>12 VEN</b> s. Clelia	12400	<b>28 DOM</b> s. Tommaso d'Aquino	28400
<b>13 SAB</b> s. Nino	13401	<b>29 LUN</b> s. Costanzo	29401
<b>14 DOM</b> s. Felice	14402	<b>30 MAR</b> s. Martina	30402
<b>15 LUN</b> s. Mauri	15403	<b>31 MER</b> s. Giovanni Eusebio	31403
<b>16 MAR</b> s. Marcello	16404		

**gen  
iona**  
**2024**

**DICEMBRE 2023**

L	M	M	G	V	S	D
				1	2	3
4	5	6	7	8	9	10
11	12	13	14	15	16	17
18	19	20	21	22	23	24
25	26	27	28	29	30	31

**CAPRICORNO**  
22/12 - 29/1

**FEBBRAIO 2024**

L	M	M	G	V	S	D
				1	2	3
4	5	6	7	8	9	10
11	12	13	14	15	16	17
18	19	20	21	22	23	24
25	26	27	28	29		

**LA LUNA**  
LUNA piena il 14/12  
LUNA nuova il 29/12  
LUNA crescente il 21/12  
LUNA calante il 05/01

**IL SOLE**  
sorge il 07/12  
tramonta il 16/12  
sorge il 08/01  
tramonta il 17/01

**IL TEMPO**  
Clima: invernale  
Clima: invernale

## PA162 Auto sportive

Illustrato mensile 12 fogli, carta patinata 70 gr testata termosaldada



- f.to calendario: 29x47 cm ca
- f.to testata: 29x9 cm ca
- 100





### Ferrari Purosangue

#### INDOLE SELVAGGIA E DESIGN ECCELLO

Lo Casa di Maranello, con il Nuovo SUV Ferrari Purosangue, introduce una sua interpretazione particolare e a distanza da tutte le concorrenti, proponendo una vettura a quattro porte, con quattro posti singoli ad altissime prestazioni, dal design dinamico ed accattivante e dotata di un potente propulsore V12 aspirato, in posizione anteriore, come da migliore tradizione della Casa del Cavallino Rampante. La Ferrari Purosangue è dotata di sei ben 725, sterzati dall'un propulsore a dodici cilindri con architettura a V e angolo tra le bancate di 65°. Ferrari Purosangue V12, raggiunge la velocità massima di 310 Km/h. Questo potentissimo crossover è dotato di un motore che permette un'accelerazione da 0 a 100 Km/h raggiunta in 3,3 secondi, ce ne vogliono 10,6 per arrivare a 200 Km/h. Il tutto si differenzia grazie ad una trazione integrale sulle quattro ruote con cambio sequenziale ad otto rapporti in posizione Trasversale (laterale), ad un cambio automatico classico con convertitore di coppia dedicato solo alla trazione delle ruote anteriori che prende potenza dalla parte anteriore del propulsore.



DIMENSIONI	
Bagagliaio:	473 lt
Capacità serbatoio:	100 lt
Lunghezza:	497 cm
Larghezza:	202 cm
Altezza:	158 cm
Passo:	301 cm

MOTORE	
Motore:	V12
Cilindrata:	6496 cc
Potenza max/velocità:	725 CV
Numero giri/min:	7750
Coppia massima:	716 Nm
Trazione:	Integrale
Cambio:	DCT
Marce:	8

PRESTAZIONI	
Velocità max:	310 km/h
Accelerazione 0-100:	3,3 sec
Consumo medio:	Benzina n.d.

### Ferrari Purosangue

#### INDOLE SELVAGGIA E DESIGN ECCELLO



DIMENSIONI	
Bagagliaio:	473 lt
Capacità serbatoio:	100 lt
Lunghezza:	497 cm
Larghezza:	202 cm
Altezza:	158 cm
Passo:	301 cm

MOTORE	
Motore:	V12
Cilindrata:	6496 cc
Potenza max/velocità:	725 CV
Numero giri/min:	7750
Coppia massima:	716 Nm
Trazione:	Integrale
Cambio:	DCT
Marce:	8

PRESTAZIONI	
Velocità max:	310 km/h
Accelerazione 0-100:	3,3 sec
Consumo medio:	Benzina n.d.

### Audi R8

#### EDIZIONE FINALE PER LA STRADA



MOTORE	
Motore:	V8
Cilindrata:	5200 cc
Potenza max/velocità:	620 CV
Numero giri/min:	7000
Coppia massima:	560 Nm
Trazione:	Integrale
Cambio:	DCT
Marce:	7

DIMENSIONI	
Bagagliaio:	110 lt
Capacità serbatoio:	70 lt
Lunghezza:	442 cm
Larghezza:	190 cm
Altezza:	127 cm
Passo:	265 cm

PRESTAZIONI	
Velocità max:	309 km/h
Accelerazione 0-100:	3,2 sec
Consumo medio:	12,4 lt/100km

### Lamborghini V10

#### UN MOTORE V10 DA URLO



DIMENSIONI	
Bagagliaio:	110 lt
Capacità serbatoio:	70 lt
Lunghezza:	442 cm
Larghezza:	190 cm
Altezza:	127 cm
Passo:	265 cm

MOTORE	
Motore:	V10
Cilindrata:	5900 cc
Potenza max/velocità:	750 CV
Numero giri/min:	8000
Coppia massima:	630 Nm
Trazione:	Integrale
Cambio:	DCT
Marce:	8

PRESTAZIONI	
Velocità max:	310 km/h
Accelerazione 0-100:	3,2 sec
Consumo medio:	12,4 lt/100km

### BMW M3

#### LA PIÙ VELOCE NELLA STORIA



MOTORE	
Motore:	V8
Cilindrata:	5000 cc
Potenza max/velocità:	523 CV
Numero giri/min:	7000
Coppia massima:	475 Nm
Trazione:	Integrale
Cambio:	DCT
Marce:	8

DIMENSIONI	
Bagagliaio:	110 lt
Capacità serbatoio:	70 lt
Lunghezza:	442 cm
Larghezza:	190 cm
Altezza:	127 cm
Passo:	265 cm

PRESTAZIONI	
Velocità max:	306 km/h
Accelerazione 0-100:	3,2 sec
Consumo medio:	12,4 lt/100km

### McLaren 720S

#### UNA BELVA PER LA PISTA



DIMENSIONI	
Bagagliaio:	110 lt
Capacità serbatoio:	70 lt
Lunghezza:	442 cm
Larghezza:	190 cm
Altezza:	127 cm
Passo:	265 cm

MOTORE	
Motore:	V8
Cilindrata:	5200 cc
Potenza max/velocità:	710 CV
Numero giri/min:	7500
Coppia massima:	560 Nm
Trazione:	Integrale
Cambio:	DCT
Marce:	8

PRESTAZIONI	
Velocità max:	341 km/h
Accelerazione 0-100:	2,9 sec
Consumo medio:	12,4 lt/100km

### Porsche Carrera GT

#### PORSCHE RIVISITA LA PROPRIA STORIA



DIMENSIONI	
Bagagliaio:	110 lt
Capacità serbatoio:	70 lt
Lunghezza:	442 cm
Larghezza:	190 cm
Altezza:	127 cm
Passo:	265 cm

MOTORE	
Motore:	V10
Cilindrata:	5900 cc
Potenza max/velocità:	750 CV
Numero giri/min:	8000
Coppia massima:	630 Nm
Trazione:	Integrale
Cambio:	DCT
Marce:	8

PRESTAZIONI	
Velocità max:	310 km/h
Accelerazione 0-100:	3,2 sec
Consumo medio:	12,4 lt/100km

### Audi R8

#### 700 CV A CIelo APERTO



MOTORE	
Motore:	V8
Cilindrata:	5200 cc
Potenza max/velocità:	620 CV
Numero giri/min:	7000
Coppia massima:	560 Nm
Trazione:	Integrale
Cambio:	DCT
Marce:	7

DIMENSIONI	
Bagagliaio:	110 lt
Capacità serbatoio:	70 lt
Lunghezza:	442 cm
Larghezza:	190 cm
Altezza:	127 cm
Passo:	265 cm

PRESTAZIONI	
Velocità max:	309 km/h
Accelerazione 0-100:	3,2 sec
Consumo medio:	12,4 lt/100km

### Ferrari Purosangue

#### INDOLE SELVAGGIA E DESIGN ECCELLO



DIMENSIONI	
Bagagliaio:	473 lt
Capacità serbatoio:	100 lt
Lunghezza:	497 cm
Larghezza:	202 cm
Altezza:	158 cm
Passo:	301 cm

MOTORE	
Motore:	V12
Cilindrata:	6496 cc
Potenza max/velocità:	725 CV
Numero giri/min:	7750
Coppia massima:	716 Nm
Trazione:	Integrale
Cambio:	DCT
Marce:	8

PRESTAZIONI	
Velocità max:	310 km/h
Accelerazione 0-100:	3,3 sec
Consumo medio:	Benzina n.d.

### Lamborghini V10

#### UN MOTORE V10 DA URLO



MOTORE	
Motore:	V10
Cilindrata:	5900 cc
Potenza max/velocità:	750 CV
Numero giri/min:	8000
Coppia massima:	630 Nm
Trazione:	Integrale
Cambio:	DCT
Marce:	8

DIMENSIONI	
Bagagliaio:	110 lt
Capacità serbatoio:	70 lt
Lunghezza:	442 cm
Larghezza:	190 cm
Altezza:	127 cm
Passo:	265 cm

PRESTAZIONI	
Velocità max:	310 km/h
Accelerazione 0-100:	3,2 sec
Consumo medio:	12,4 lt/100km

### Porsche SUV

#### LA SUV IN CHIAVE SPORTIVA



DIMENSIONI	
Bagagliaio:	110 lt
Capacità serbatoio:	70 lt
Lunghezza:	442 cm
Larghezza:	190 cm
Altezza:	127 cm
Passo:	265 cm

MOTORE	
Motore:	V8
Cilindrata:	5000 cc
Potenza max/velocità:	523 CV
Numero giri/min:	7000
Coppia massima:	475 Nm
Trazione:	Integrale
Cambio:	DCT
Marce:	8

PRESTAZIONI	
Velocità max:	306 km/h
Accelerazione 0-100:	3,2 sec
Consumo medio:	12,4 lt/100km

### Mercedes-Benz

#### LA NUOVA GENERAZIONE DI GRAN TURISMO



MOTORE	
Motore:	V8
Cilindrata:	5000 cc
Potenza max/velocità:	523 CV
Numero giri/min:	7000
Coppia massima:	475 Nm
Trazione:	Integrale
Cambio:	DCT
Marce:	8

DIMENSIONI	
Bagagliaio:	110 lt
Capacità serbatoio:	70 lt
Lunghezza:	442 cm
Larghezza:	190 cm
Altezza:	127 cm
Passo:	265 cm

PRESTAZIONI	
Velocità max:	306 km/h
Accelerazione 0-100:	3,2 sec
Consumo medio:	12,4 lt/100km

### Mercedes-Benz

#### 600 CV IBRIDO PER LA CIOÙ SE



DIMENSIONI	
Bagagliaio:	110 lt
Capacità serbatoio:	70 lt
Lunghezza:	442 cm
Larghezza:	190 cm
Altezza:	127 cm
Passo:	265 cm

MOTORE	
Motore:	V8
Cilindrata:	5000 cc
Potenza max/velocità:	600 CV
Numero giri/min:	7000
Coppia massima:	475 Nm
Trazione:	Integrale
Cambio:	DCT
Marce:	8

PRESTAZIONI	
Velocità max:	306 km/h
Accelerazione 0-100:	3,2 sec
Consumo medio:	12,4 lt/100km

# PA187 Gastronomia



formato  
14x47 cm ca

Festività  
Internazionali

Retrostampato

### Ziti alla genovese



**Ingredienti:**

Ziti 200 g	Sedano 50 g	Affetto di foglie
Spatola 500 g	Carote 50 g	Speie ab.
Sottopasta 300 g	Olio EVO 100 g	Pepi ab.
Cipolle 1-2 kg	Vino bianco 300 g	

Alfanzese le cipolle liberatamente scelti, lavate il sedano e la carota. Tagliate la carota a pezzi di 3 cm di lato, e mi di spessore. Scaldare una casseruola, versare la metà dell'olio e rosolare bene la carne per 3-10 minuti, quindi rinnovare il mestolo da parte. Unire il resto dell'olio, le cipolle, il sedano e la carota, rosolare a cubetti per 15 minuti a fuoco medio, coperto, mescolando ogni 2 minuti. Riunire la carne nella casseruola, unire ad olio, farlo evaporare il fucolo olio, aggiungere mezzo litro di acqua e le foglie di celano, profumare con abbondante di fucolo abito, coprire e cuocere a fuoco basso per 2 ore, mescolando di tanto in tanto facendo attenzione affinché il sugo non si seccasse troppo e mescolando spesso nell'ultimo fase della cottura, quando il sugo tenderà a sciolersi. Regolare di sale e pepe, conchiuso le foglie di celano. Buttare la pasta in acqua bollente, scolarla. Mettere a bagno alla genovese in una padella arroventata insieme a un pizzico di aceto di cottura della pasta, accendere la fiamma quando mancino. 3 minuti alla cottura della pasta. Scolare la pasta su forche e farla ricoprire nel sugo.

### Parmigiana di melanzane



**Ingredienti:**

Melanzane 1 kg	Parmigiano 100 g	Olio EVO ab.
Pomodoro 500 ml	Aglio 3 spicchi	Speie ab.
Melanzane 300 g	Basilico 1 mazzetta	Pepi ab.
Cipolle 1/2	CMA per frittura 1 litro	

Per primo cosa lavate le melanzane, mondatele e tagliatele a fette della spessore di circa mezzo centimetro nel senso della lunghezza. Una volta tagliate disponete le fette a smalti in un colabrodo e scorporate di olio. Lasciatele per 1 ora per il tempo necessario a far perdere l'acqua vegetale. Sottogate la cipolla tritata e faglie schiacciate con 2-3 cucchiai di olio extravergine di oliva, foglie di basilico, aggiungete la passata di pomodoro, il basilico, il sale, il pepe e cuocete il sugo per 15-20 minuti. Passate ora le melanzane nella farina. Questo passaggio nel procedimento non viene svolto da tutti, alcune preferiscono passare direttamente le faglie le melanzane piccole alla volta, in abbondante olio per frittura, bene caldo, faccile di rosare su entrambi i lati. Tagliate la mozzarella a fette. Cominciate ora di rosolare la parmigiana di melanzane, in una pentola versate per fondo una pad di acqua e aromatizzate con strati di melanzane, ricoprite con qualche cucchiaio di parmigiano grattugiato, il basilico e le fette di mozzarella. Continuate con gli strati, seguendo lo stesso ordine, fino al esaurimento degli ingredienti. Cuocete in forno caldo a 180° per 30 minuti.

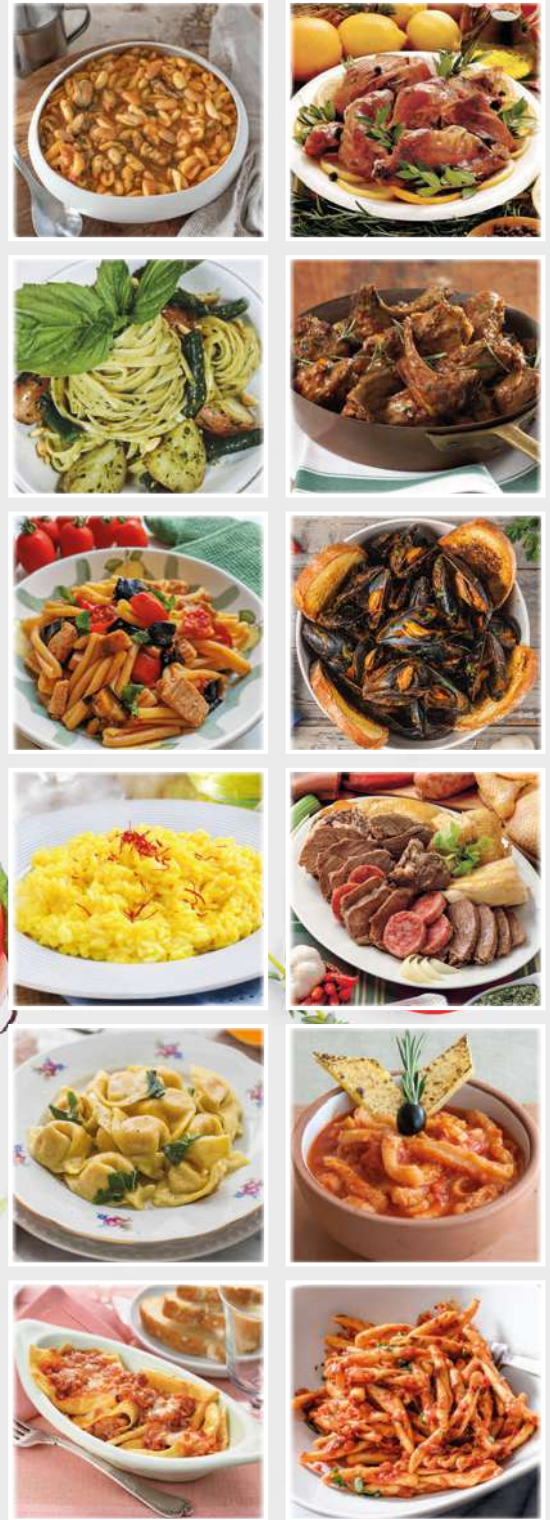

## PA187 Gastronomia

Silhouette mensile 12 fogli, carta patinata 70 gr testata termosaldata



- f.to calendario: 14x47 cm ca
- f.to testata: 14x9 cm ca
- 100



# PA189 Carni

 formato  
14x47 cm ca

 Festività  
Internazionali

Retrostampato



**GENNAIO 2024**

<b>1 Lun</b> <small>1. Maria Maddalena (Egitto) - Capodanno</small>	<b>17 Mer</b> <small>1. Antonio Abate</small>
<b>2 Mar</b> <small>1. Spirito e Angela</small>	<b>18 Gio</b> <small>1. Luciano</small>
<b>3 Mer</b> <small>1. Costanzo</small>	<b>19 Ven</b> <small>1. Maria</small>
<b>4 Gio</b> <small>1. Evodio e Lino</small>	<b>20 Sab</b> <small>1. Sebastiano e Fabiano</small>
<b>5 Ven</b> <small>1. Maria</small>	<b>21 Dom</b> <small>1. Filippo</small>
<b>6 Sab</b> <small>1. Felice e Nino</small>	<b>22 Lun</b> <small>1. Teodoro</small>
<b>7 Dom</b> <small>1. Eusebio e Lino</small>	<b>23 Mar</b> <small>1. Costantino</small>
<b>8 Lun</b> <small>1. Massimo</small>	<b>24 Mer</b> <small>1. Francesco d'Assisi</small>
<b>9 Mar</b> <small>1. Luciano</small>	<b>25 Gio</b> <small>1. Costantino II e Paolo</small>
<b>10 Mer</b> <small>1. Lino</small>	<b>26 Ven</b> <small>1. Teodoro</small>
<b>11 Gio</b> <small>1. Lino</small>	<b>27 Sab</b> <small>1. Sergio e Maria</small>
<b>12 Ven</b> <small>1. Lino</small>	<b>28 Dom</b> <small>1. Tommaso e Giacomo</small>
<b>13 Sab</b> <small>1. Lino</small>	<b>29 Lun</b> <small>1. Lino</small>
<b>14 Dom</b> <small>1. Felice</small>	<b>30 Mar</b> <small>1. Costantino</small>
<b>15 Lun</b> <small>1. Felice</small>	<b>31 Mer</b> <small>1. Costantino</small>
<b>16 Mar</b> <small>1. Felice</small>	



### Costine di maiale

**Ingredienti**

12 Costine di maiale - 1 pizzico di origano - EVO  
 succo di 1 limone - 1 pizzico di timo - sale qb  
 2 spicchi d'aglio - 1/2 bicchiere d'olio - pepe ab.

**Preparazione**

Sistemare le costine in una griglia e bagnarle con il succo di limone e l'olio. Unire gli spicchi d'aglio sminuzzati, l'origano, il timo, il sale ed il pepe in grani. Mescolare con cura, poi coprire la griglia con la pellicola trasparente. Lasciare riposare le costine in frigorifero per un'ora. Avere l'accostezza di giorno, dopo 30 minuti, in modo che si saponificano da tutti i lati. Trascorso il tempo della marinatura, saponificare le costine di maiale, poi posare sulla griglia ben calda del barbecue. Lasciare cuocere per 15-18 minuti, girandole a metà cottura. Il tempo è puramente indicativo, in quanto dipende dalle dimensioni delle costine di maiale. Se si preferiscono più morbide, durante la cottura bagnarle con il liquido della marinata. Servire le costine di maiale appena pronte, in modo che si possano assaporare ben calde.

**Vini**

Amarone della Valpolicella  
 Bolgheri Rosso  
 Syrah  
 Pinotino di Maremma  
 Sangiovese

## PA189 Carni

Silhouette mensile 12 fogli, carta patinata 70 gr testata termosaldata



- f.to calendario: 14x47 cm ca
- f.to testata: 14x9 cm ca
- 100



# PA191 Cani e gatti



formato  
14x47 cm ca

Festività  
Internazionali

Retrostampato



## PA191 Cani e gatti

Silhouette mensile 12 fogli, carta patinata 70 gr  
testata termosaldata



f.to calendario: 14x47 cm ca

f.to testata: 14x9 cm ca

100



05

# Calendari illustrati da tavolo



# PA401 Città d'Italia

formato  
19x14,5 cm ca

Festività  
Internazionali



La carta proviene da  
materiale certificato  
FSC®, materiale riciclato  
e/o legno controllato.



Tabella  
2025  
in ultima  
pagina

## PA401 Città d'Italia

Spiralato da tavolo illustrato 13 fogli  
carta patinata 90 gr  
supporto cartoncino bianco 450 gr



- f.to calendario: 19x14,5 cm ca
- f.to piedino: 19x3,5 cm ca
- 100



# PA402 Mete da sogno

formato 19x14,5 cm ca  Festività Internazionali



La carta proviene da materiale certificato FSC®, materiale riciclato e/o legno controllato.



Tabella 2025 in ultima pagina



## PA402 Mete da sogno

Spiralato da tavolo illustrato 13 fogli carta patinata 90 gr supporto cartoncino bianco 450 gr



- f.to calendario: 19x14,5 cm ca
- f.to piedino: 19x3,5 cm ca
- 100

# PA403 Cani e gatti

formato  
19x14,5 cm ca



Festività  
Internazionali



La carta proviene da  
materiale certificato  
FSC®, materiale riciclato  
e/o legno controllato.



Tabella  
2025  
in ultima  
pagina

## PA403 Cani e gatti

Spiralato da tavolo illustrato 13 fogli  
carta patinata 90 gr  
supporto cartoncino bianco 450 gr



- f.to calendario: 19x14,5 cm ca
- f.to piedino: 19x3,5 cm ca
- 100





# PA406 Auto sportive

formato 19x14,5 cm ca  Festività Internazionali

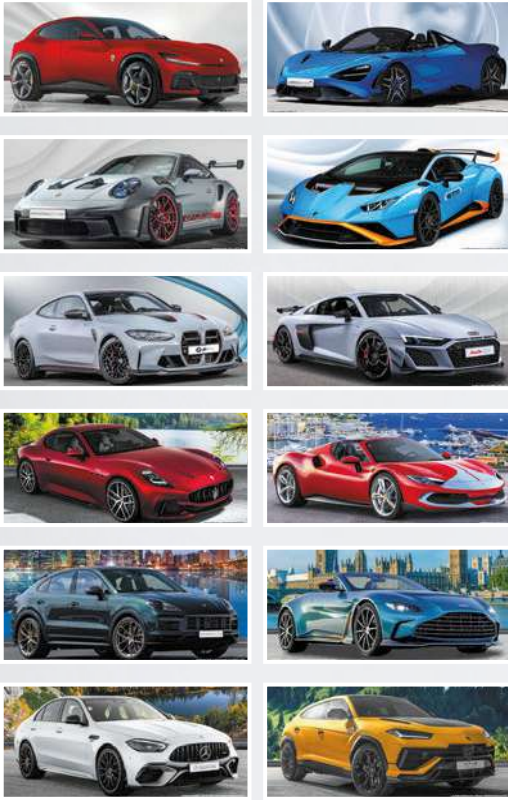

La carta proviene da materiale certificato FSC®, materiale riciclato e/o legno controllato.



Tabella 2025 in ultima pagina

## PA406 Auto sportive

Spiralato da tavolo illustrato 13 fogli carta patinata 90 gr supporto cartoncino bianco 450 gr



- f.to calendario: 19x14,5 cm ca
- f.to piedino: 19x3,5 cm ca
- 100

# Planning multicolor

## in cartoncino bianco

formato  
43x31 cm ca

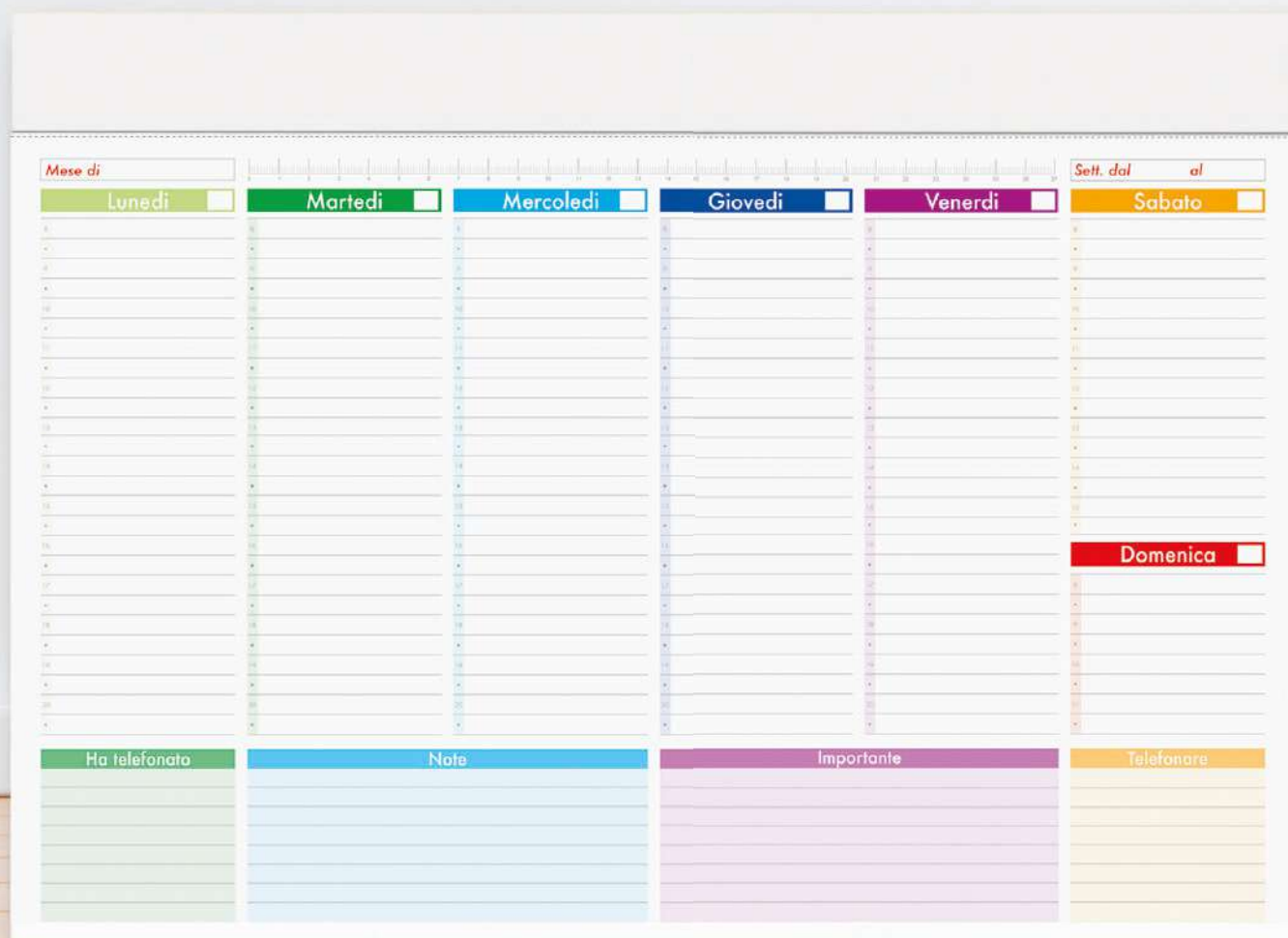

### PA802 Planning

Planning multicolor  
testata in cartoncino bianco



- f.to planning: 43x31 cm ca
- f.to testata: 43x4 cm ca
- 25



La carta proviene da  
materiale certificato FSC,  
materiale riciclato e/o  
legno controllato.

### PA806 Mini Planning

Planning multicolor, testata in cartoncino bianco



- f.to planning: 29,6x21,5 cm ca
- f.to testata: 29,6x3 cm ca
- 25

formato  
29,6x21,5 cm ca

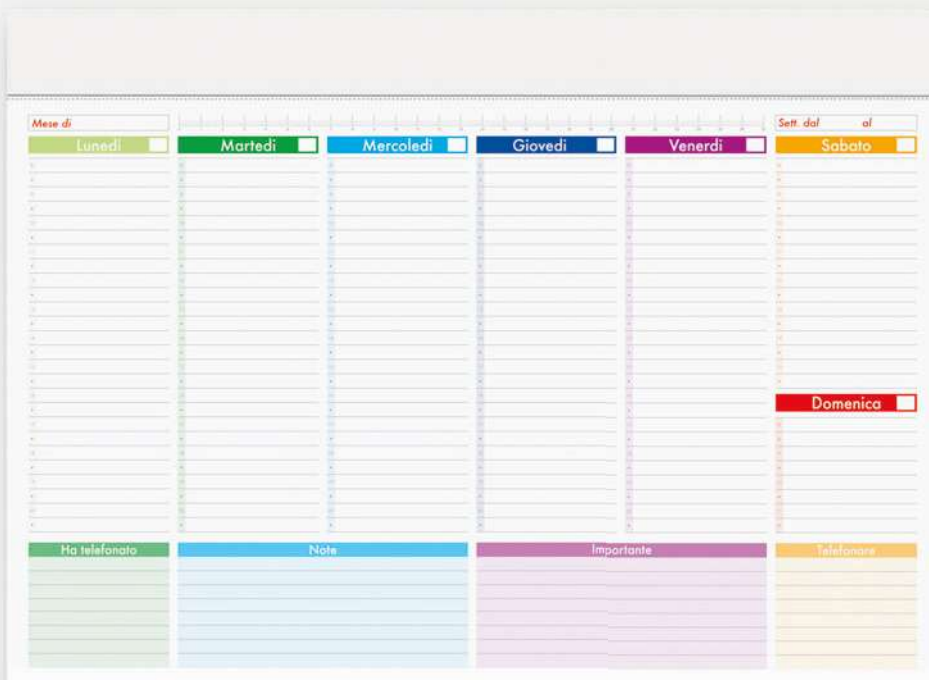

La carta proviene da materiale certificato FSC, materiale riciclato e/o legno controllato.

### PA807 Slim Planning

Planning multicolor, testata in cartoncino bianco

**NEW!**



- f.to planning: 29,4x14,5 cm ca
- f.to testata: 29,4x3 cm ca
- 30

formato  
29,4x14,5 cm ca



# Interni per agende blocco mobile edizione 2024



La carta proviene da  
materiale certificato FSC,  
materiale riciclato e/o  
legno controllato.



## PB003 f.to 17x24

## PB001 f.to 15x21



### Interni giornalieri sabato e domenica abbinati

Interno 324 pagine sab. e dom. abbinati, taglio naturale  
segnapagine, carta bianca con stampa a 2 colori  
edizione multilingue: IT-GB-FR-DE-ES-PT  
inserti informativi e rubrica telefonica, quadranti cartonati



**PB001TN 15x21**

☑ f.to interno: 15x21 cm ca

📦 40



**PB003TN 17x24**

☑ f.to interno: 17x24 cm ca

📦 40

## PB004 f.to 17x24

## PB002 f.to 15x21



### Interni giornalieri sabato e domenica separati

Interno 404 pagine sab. e dom. abbinati, taglio naturale  
 segnapagina, carta bianca con stampa a 2 colori  
 edizione multilingue: IT-GB-FR-DE-ES-PT  
 inserti informativi e rubrica telefonica, quadranti cartonati



### PB002TN 15x21

☑ f.to interno: 15x21 cm ca  
 📦 40



### PB004TN 17x24

☑ f.to interno: 17x24 cm ca  
 📦 40

### Interno settimanale

Interno settimanale 132 pagine  
 taglio naturale  
 segnapagina  
 carta bianca  
 stampa a 2 colori  
 edizione multilingue  
 IT-GB-FR-DE-ES-PT  
 inserti informativi  
 rubrica telefonica  
 quadranti cartonati

## PB005 f.to 17x24



### PB005TN 17x24

☑ f.to interno: 17x24 cm ca  
 📦 30



# Blocchi per appunti

Formato A4:  
righe, quadretti  
e quadrettini

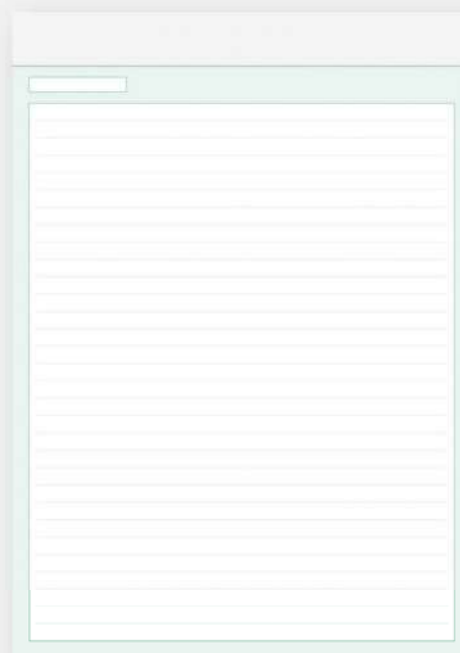
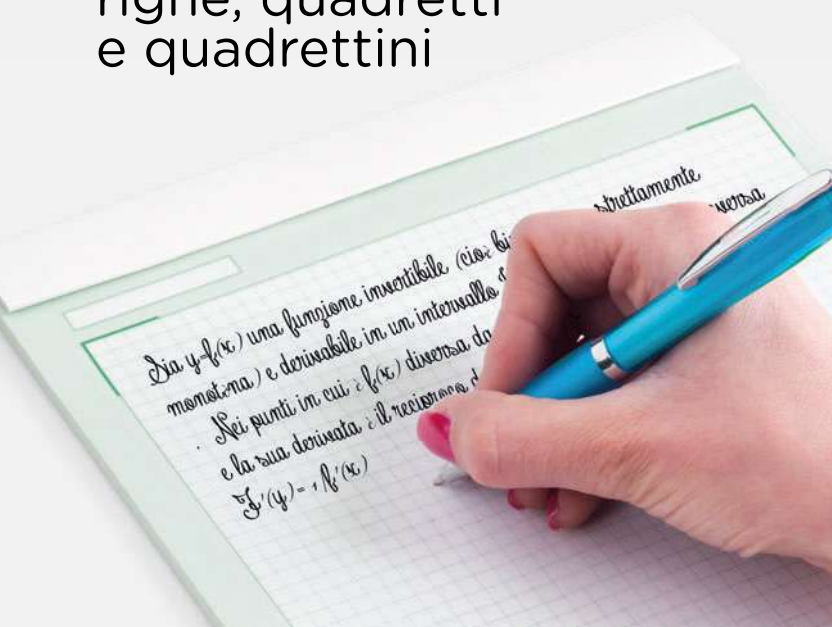

## PA840 Block line

Blocco A4 50 fogli a righe



☑ f.to blocco: 21x29,8 cm ca

☑ f.to testata: 21x3 cm ca

📦 25

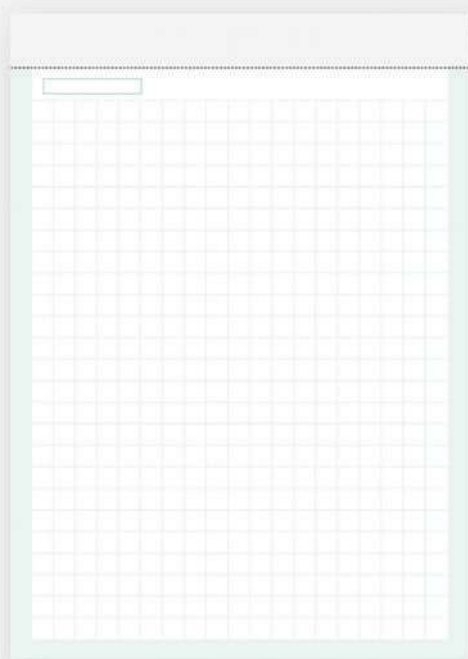

## PA842 Block square

Blocco A4 50 fogli a quadretti



☑ f.to blocco: 21x29,8 cm ca

☑ f.to testata: 21x3 cm ca

📦 25

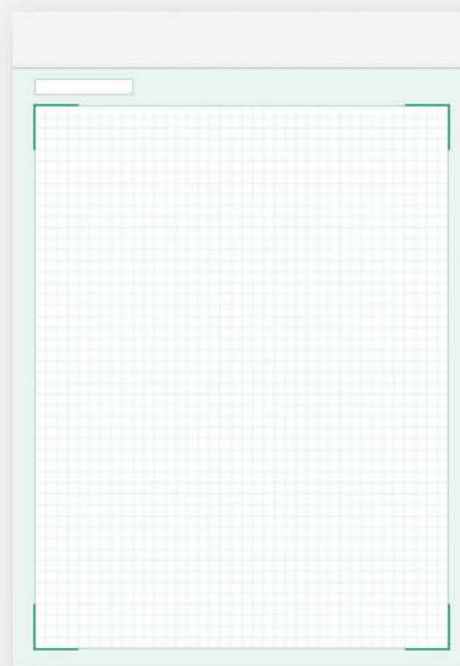

## PA844 Block milly

Blocco A4 50 fogli a quadrettini



☑ f.to blocco: 21x29,8 cm ca

☑ f.to testata: 21x3 cm ca

📦 25

07

# Agende blocco mobile





Termovirante

## PB025 AGENDA

## PB026 MAXI AGENDA

Agenda borsello  
chiusura con cerniera  
interno multitasche  
segnapagine, edizione multilingua  
inserto cartografico  
rubrica telefonica  
corredata di astuccio  
materiale: poliuretano termovirante



Corredata di astuccio in cartone



CU



BL



NE



RO



**PB025SDA** Agenda

324 pag. sab. e dom. abbinati

- f.to copertina: 17,5x25 cm ca
- f.to interno: 15x21 cm ca  1/20

**PB025SDS** Agenda

404 pag. sab. e dom. separati

- f.to copertina: 17,5x25 cm ca
- f.to interno: 15x21 cm ca  1/20

**PB026SDA** Maxi agenda

324 pag. sab. e dom. abbinati

- f.to copertina: 20x28 cm ca
- f.to interno: 17x24 cm ca  1/20

**PB026SDS** Maxi agenda

404 pag. sab. e dom. separati

- f.to copertina: 20x28 cm ca
- f.to interno: 17x24 cm ca  1/20

**PB026SET** Maxi agenda

132 pag. settimanali

- f.to copertina: 20x28 cm ca
- f.to interno: 17x24 cm ca  1/20



La carta proviene da  
materiale certificato FSC,  
materiale riciclato e/o  
legno controllato.



Inserito cartografico



Termovirante

## **PB028 MAXI AGENDA** **PB029 AGENDA**

Agenda portafoglio  
 chiusura con magnete  
 asola portapenna  
 tasche interne portacards  
 segnapagina  
 edizione multilingua  
 inserto cartografico  
 rubrica telefonica  
 corredata di astuccio  
 materiale: poliuretano termovirante



Corredata di astuccio in cartone

**PB029SDA** Agenda

324 pag. sab. e dom. abbinati

- f.to copertina: 20x24,5 cm ca
- f.to interno: 15x21 cm ca  1/20

**PB029SDS** Agenda

404 pag. sab. e dom. separati

- f.to copertina: 20x24,5 cm ca
- f.to interno: 15x21 cm ca  1/20

**PB028SDA** Maxi agenda

324 pag. sab. e dom. abbinati

- f.to copertina: 22x27,5 cm ca
- f.to interno: 17x24 cm ca  1/20

**PB028SDS** Maxi agenda

404 pag. sab. e dom. separati

- f.to copertina: 22x27,5 cm ca
- f.to interno: 17x24 cm ca  1/20

**PB028SET** Maxi agenda

132 pag. settimanali

- f.to copertina: 22x27,5 cm ca
- f.to interno: 17x24 cm ca  1/20



La carta proviene da  
materiale certificato FSC,  
materiale riciclato e/o  
legno controllato.



Inserito cartografico



Termovirante

## PB049 AGENDA PB052 MAXI AGENDA

Agenda borsello, chiusura con cerniera  
tasche interne, edizione multilingua  
inserto cartografico, rubrica telefonica  
corredata di astuccio  
materiale: poliuretano termovirante



Corredata di astuccio in cartone



**PB049DA** Agenda

324 pag. sab. e dom. abbinati

- f.to copertina: 18x23 cm ca
- f.to interno: 15x21 cm ca  1/20

**PB049SDS** Agenda

404 pag. sab. e dom. separati

- f.to copertina: 18x23 cm ca
- f.to interno: 15x21 cm ca  1/20

**PB052SDA** Maxi agenda

324 pag. sab. e dom. abbinati

- f.to copertina: 22x28 cm ca
- f.to interno: 17x24 cm ca  1/20

**PB052SDS** Maxi agenda

404 pag. sab. e dom. separati

- f.to copertina: 22x28 cm ca
- f.to interno: 17x24 cm ca  1/20

**PB052SET** Maxi agenda

132 pag. settimanali

- f.to copertina: 22x28 cm ca
- f.to interno: 17x24 cm ca  1/20



La carta proviene da  
materiale certificato FSC,  
materiale riciclato e/o  
legno controllato.



Inserito cartografico



BL

## PB214 AGENDA PB216 MAXI AGENDA

Agenda portafoglio, chiusura con fibbia  
tasche interne, segnapagina  
edizione multilingua, inserto cartografico  
rubrica telefonica, corredata di astuccio  
materiale: ecopelle



Corredata di astuccio in cartone



CU

MA

NE

**PB214SDA** Agenda

324 pag. sab. e dom. abbinati

- f.to copertina: 16x21,5 cm ca
- f.to interno: 15x21 cm ca  1/20

**PB214SDS** Agenda

404 pag. sab. e dom. separati

- f.to copertina: 16x21,5 cm ca
- f.to interno: 15x21 cm ca  1/20

**PB216SDA** Maxi agenda

324 pag. sab. e dom. abbinati

- f.to copertina: 18,5x25 cm ca
- f.to interno: 17x24 cm ca  1/20

**PB216SDS** Maxi agenda

404 pag. sab. e dom. separati

- f.to copertina: 18,5x25 cm ca
- f.to interno: 17x24 cm ca  1/20

**PB216SET** Maxi agenda

132 pag. settimanali

- f.to copertina: 18,5x25 cm ca
- f.to interno: 17x24 cm ca  1/20



La carta proviene da  
materiale certificato FSC,  
materiale riciclato e/o  
legno controllato.



Insero cartografico



Termovirante

## PB217 AGENDA PB219 MAXI AGENDA

Agenda portafoglio, chiusura con elastico segnapagina, edizione multilingua inserto cartografico, rubrica telefonica corredata di astuccio materiale: poliuretano termovirante



Chiusura con elastico



Corredata di astuccio in cartone





**PB217SDA** Agenda



324 pag. sab. e dom. abbinati  
 f.to copertina: 17,5x22 cm ca  
 f.to interno: 15x21 cm ca 1/20



**PB217SDS** Agenda



404 pag. sab. e dom. separati  
 f.to copertina: 17,5x22 cm ca  
 f.to interno: 15x21 cm ca 1/20



**PB219SDA** Maxi agenda



324 pag. sab. e dom. abbinati  
 f.to copertina: 19x25,5 cm ca  
 f.to interno: 17x24 cm ca 1/20



**PB219SDS** Maxi agenda



404 pag. sab. e dom. separati  
 f.to copertina: 19x25,5 cm ca  
 f.to interno: 17x24 cm ca 1/20



**PB219SET** Maxi agenda



132 pag. settimanali  
 f.to copertina: 19x25,5 cm ca  
 f.to interno: 17x24 cm ca 1/20



La carta proviene da materiale certificato FSC, materiale riciclato e/o legno controllato.



Inserto cartografico



## **PB226 AGENDA** **PB227 MAXI AGENDA**

Agenda portafoglio chiusura con fibbia  
segnapagina, edizione multilingua  
inserto cartografico, rubrica telefonica  
corredata di astuccio  
materiale: ecopelle



Corredata di astuccio in cartone



**PB226SDA** Agenda



324 pag. sab. e dom. abbinati  
 f.to copertina: 16,5x22 cm ca  
 f.to interno: 15x21 cm ca 1/20



**PB226SDS** Agenda



404 pag. sab. e dom. separati  
 f.to copertina: 16,5x22 cm ca  
 f.to interno: 15x21 cm ca 1/20



**PB227SDA** Maxi agenda



324 pag. sab. e dom. abbinati  
 f.to copertina: 21x29,7 cm ca  
 f.to interno: 17x24 cm ca 1/20



**PB227SDS** Maxi agenda



404 pag. sab. e dom. separati  
 f.to copertina: 21x29,7 cm ca  
 f.to interno: 17x24 cm ca 1/20



**PB227SET** Maxi agenda



132 pag. settimanali  
 f.to copertina: 21x29,7 cm ca  
 f.to interno: 17x24 cm ca 1/20



La carta proviene da materiale certificato FSC, materiale riciclato e/o legno controllato.



Inserto cartografico

f.to 17,5x24,5

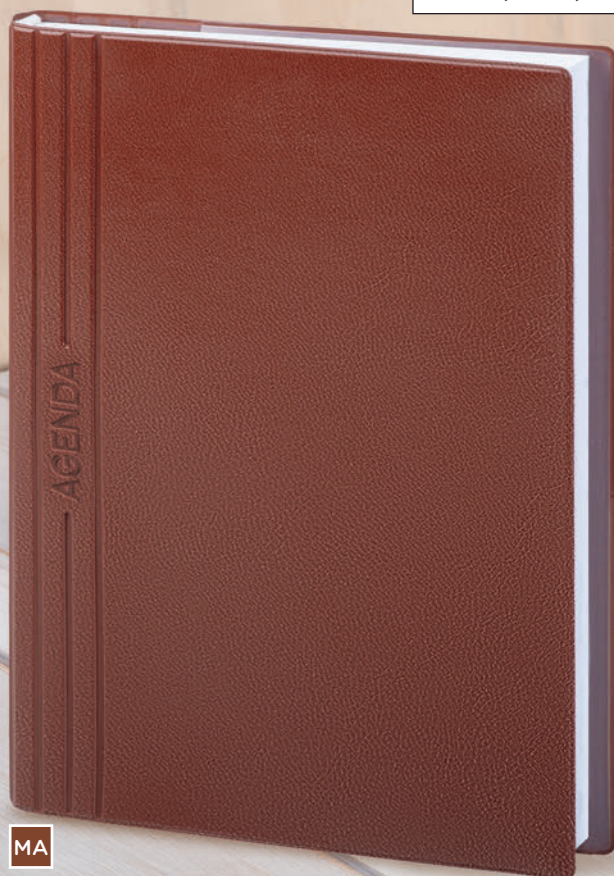

MA

f.to 15,5x21,5

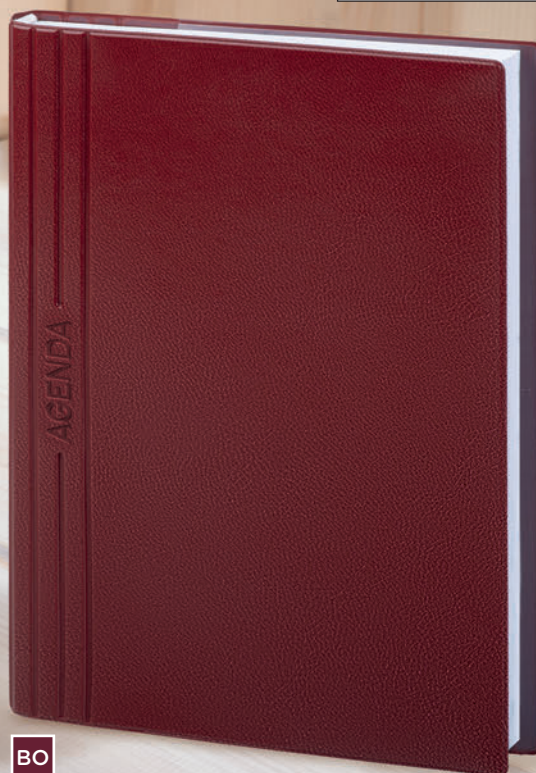

BO

f.to 8,5x15,5



BL

## Agende Flessibili Classic

Edizione multilingua, interno intercambiabile  
rubrica telefonica, inserto cartografico, materiale: pvc

**PB200** 15,5x21,5 sda

**AS010** Astuccio su richiesta

**PB201** 15,5x21,5 sds

**AS010** Astuccio su richiesta

**PB203** 17,5x24,5 sds

**AS020** Astuccio su richiesta

**PB204** 17,5x24,5 set

**AS030** Astuccio su richiesta

**PB205** 8,5x15,5 set

**AS040** Astuccio su richiesta



Copertina in pvc flessibile

MA

BO

RO

BL

NE

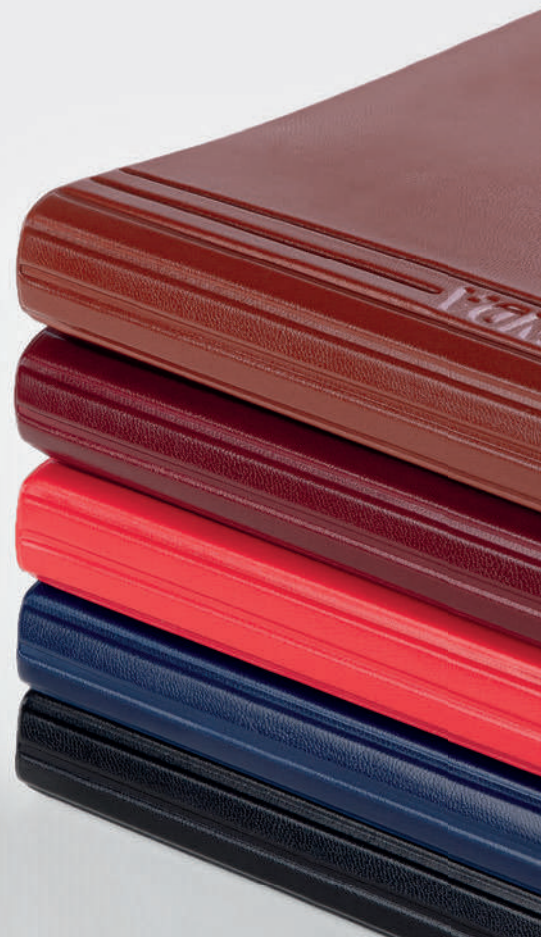

### PB200 Agenda



324 pag. sab. e dom. abbinati

- f.to copertina: 15,5x21,5 cm ca
- f.to interno: 15x21 cm ca 1/20

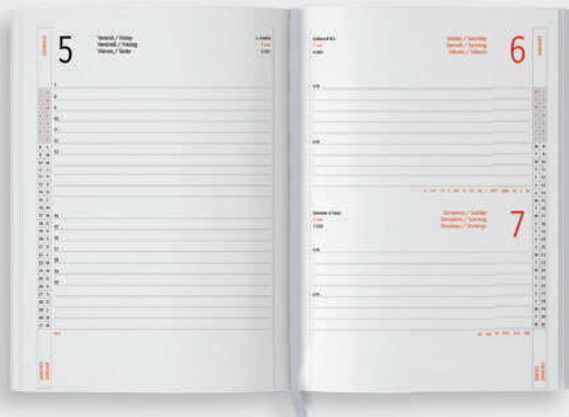

### PB201 Agenda



404 pag. sab. e dom. separati

- f.to copertina: 15,5x21,5 cm ca
- f.to interno: 15x21 cm ca 1/20



### PB203 Maxi agenda



404 pag. sab. e dom. separati

- f.to copertina: 17,5x24,5 cm ca
- f.to interno: 17x24 cm ca 1/20

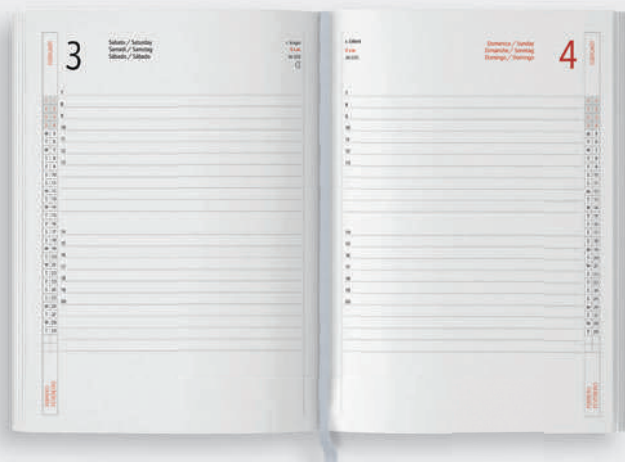

### PB204 Maxi agenda



132 pag. settimanali

- f.to copertina: 17,5x24,5 cm ca
- f.to interno: 17x24 cm ca 1/20



### PB205 Agenda



132 pag. settimanali

- f.to copertina: 8,5x15,5 cm ca
- f.to interno: 8x15 cm ca 1/20



La carta proviene da materiale certificato FSC, materiale riciclato e/o legno controllato.



Inserto cartografico

f.to 17,5x24,5

f.to 15,5x21,5

f.to 8,5x15,5



AZ



VL



RY

## Agende Flessibili in Tam

Edizione multilingua, interno intercambiabile  
rubrica telefonica, inserto cartografico, materiale: tam

**PB206** 15,5x21,5 sda  
**AS010** Astuccio su richiesta

**PB207** 17,5x24,5 sda  
**AS020** Astuccio su richiesta

**PB208** 17,5x24,5 set  
**AS030** Astuccio su richiesta

**PB209** 8,5x15,5 set  
**AS040** Astuccio su richiesta



Copertina in tam flessibile

AZ

BL

RY

AR

RO

VL

GR

BI

NE



**PB206** Agenda



324 pag. sab. e dom. abbinati  
 f.to copertina: 15,5x21,5 cm ca  
 f.to interno: 15x21 cm ca 1/20



**PB207** Maxi agenda



324 pag. sab. e dom. abbinati  
 f.to copertina: 17,5x24,5 cm ca  
 f.to interno: 17x24 cm ca 1/20



La carta proviene da materiale certificato FSC, materiale riciclato e/o legno controllato.

**PB208** Maxi agenda



132 pag. settimanali  
 f.to copertina: 17,5x24,5 cm ca  
 f.to interno: 17x24 cm ca 1/20



**PB209** Agenda



132 pag. settimanali  
 f.to copertina: 8,5x15,5 cm ca  
 f.to interno: 8x15 cm ca 1/20



08

# Agende blocco fisso

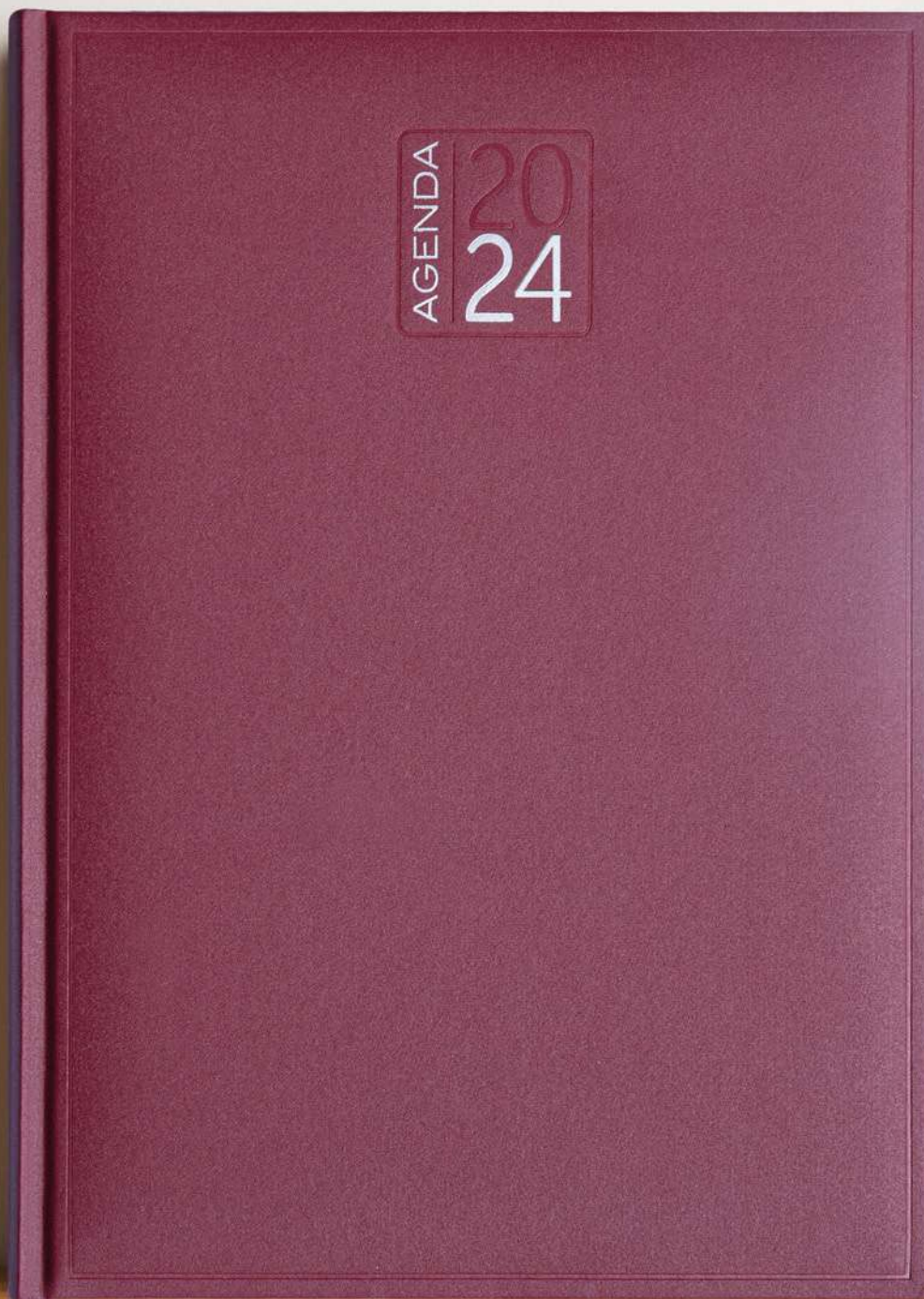



# Astucci per agende

disponibili nelle varianti: blu, grigio, fantasia geometrica

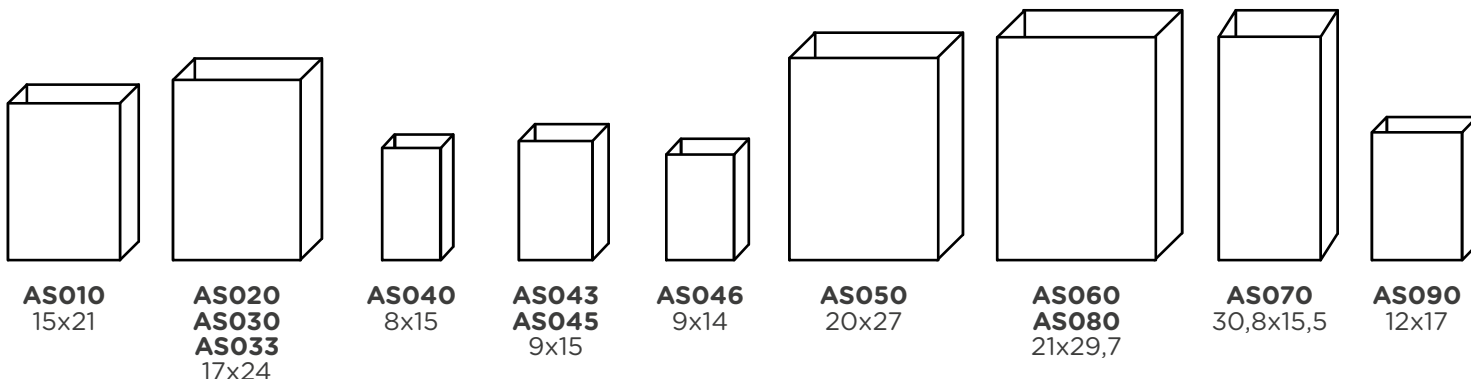



NEW!

f.to 21x26 settimanale

MA

Termovirante

**PB256 Manager Settimanale**

264 pagine carta avorio  
 16 pagine inserto cartografico mondiale  
 stampa a 1 colore, inserti informativi  
 edizione multilingue: IT - GB  
 rubrica telefonica, segnapagina doppio  
 quadranti imbottiti cuciti, astuccio lusso  
 materiale: poliuretano termovirante



f.to agenda: 21x26 cm ca  
 1/5

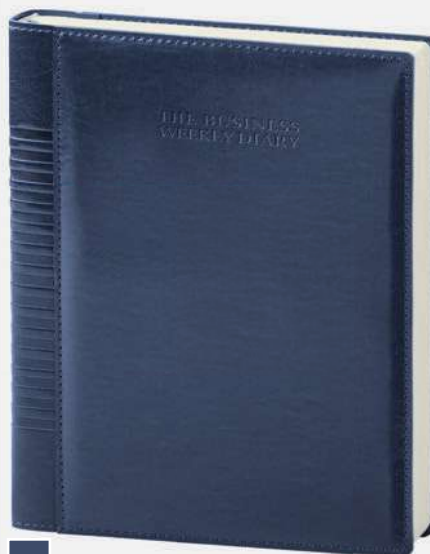

BL

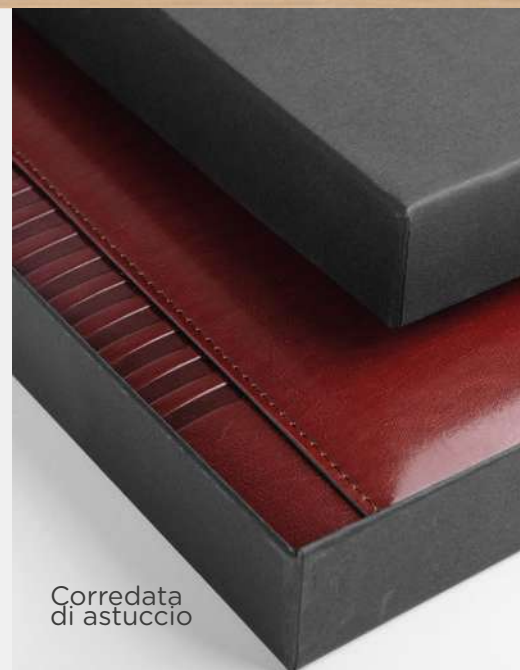
Corredata  
di astuccio

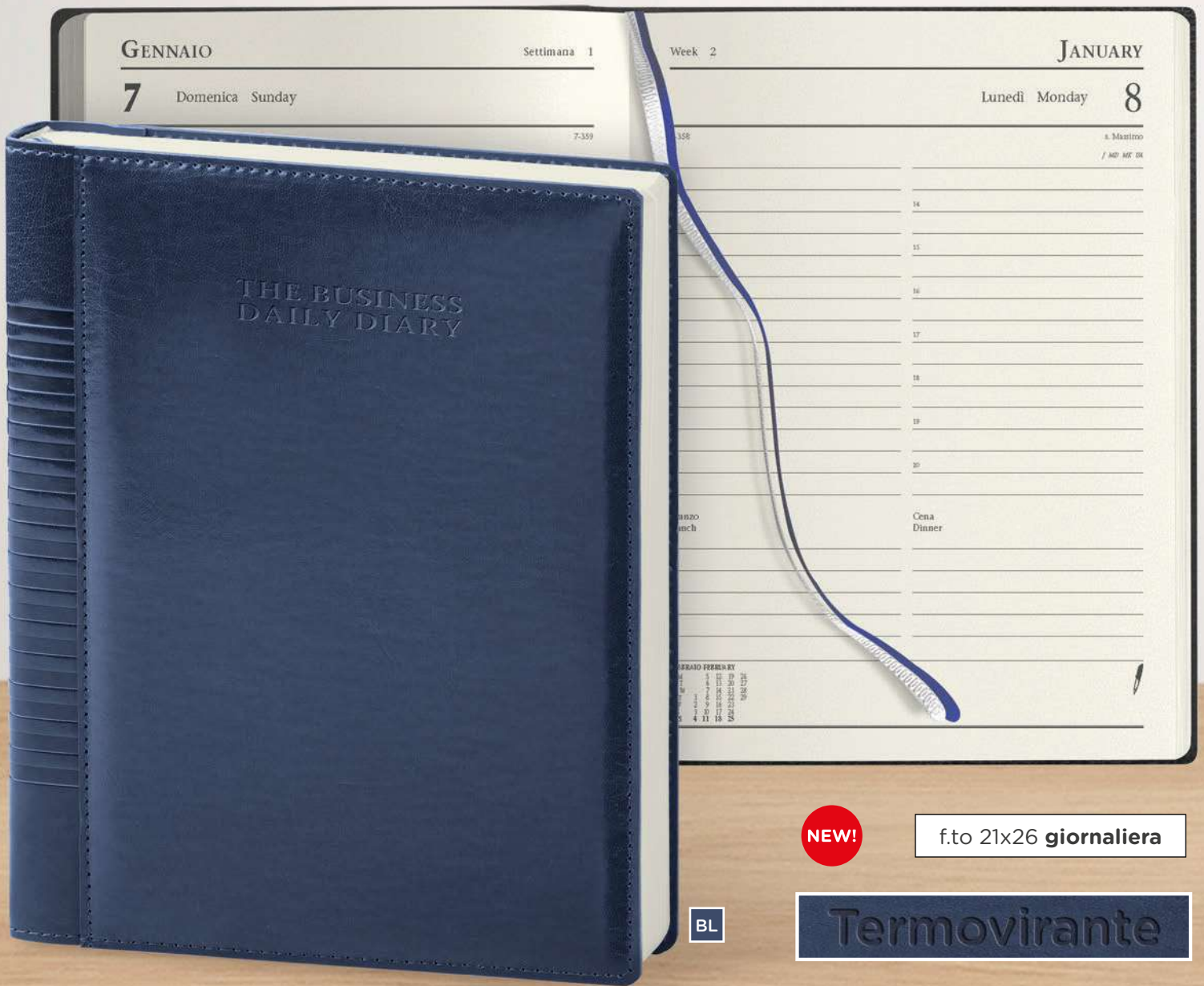

**PB258 Manager Giornaliera**

434 pagine carta avorio  
 16 pagine inserto cartografico mondiale  
 stampa a 1 colore, inserti informativi  
 edizione multilingue: IT - GB  
 rubrica telefonica, segnapagina doppio  
 quadranti imbottiti cuciti, astuccio lusso  
 materiale: poliuretano termovirante



☑ f.to agenda: 21x26 cm ca  
 ☑ 1/5

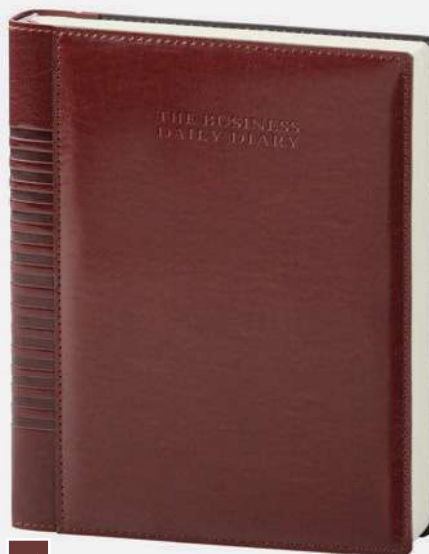

MA



Corredata  
 di astuccio

121

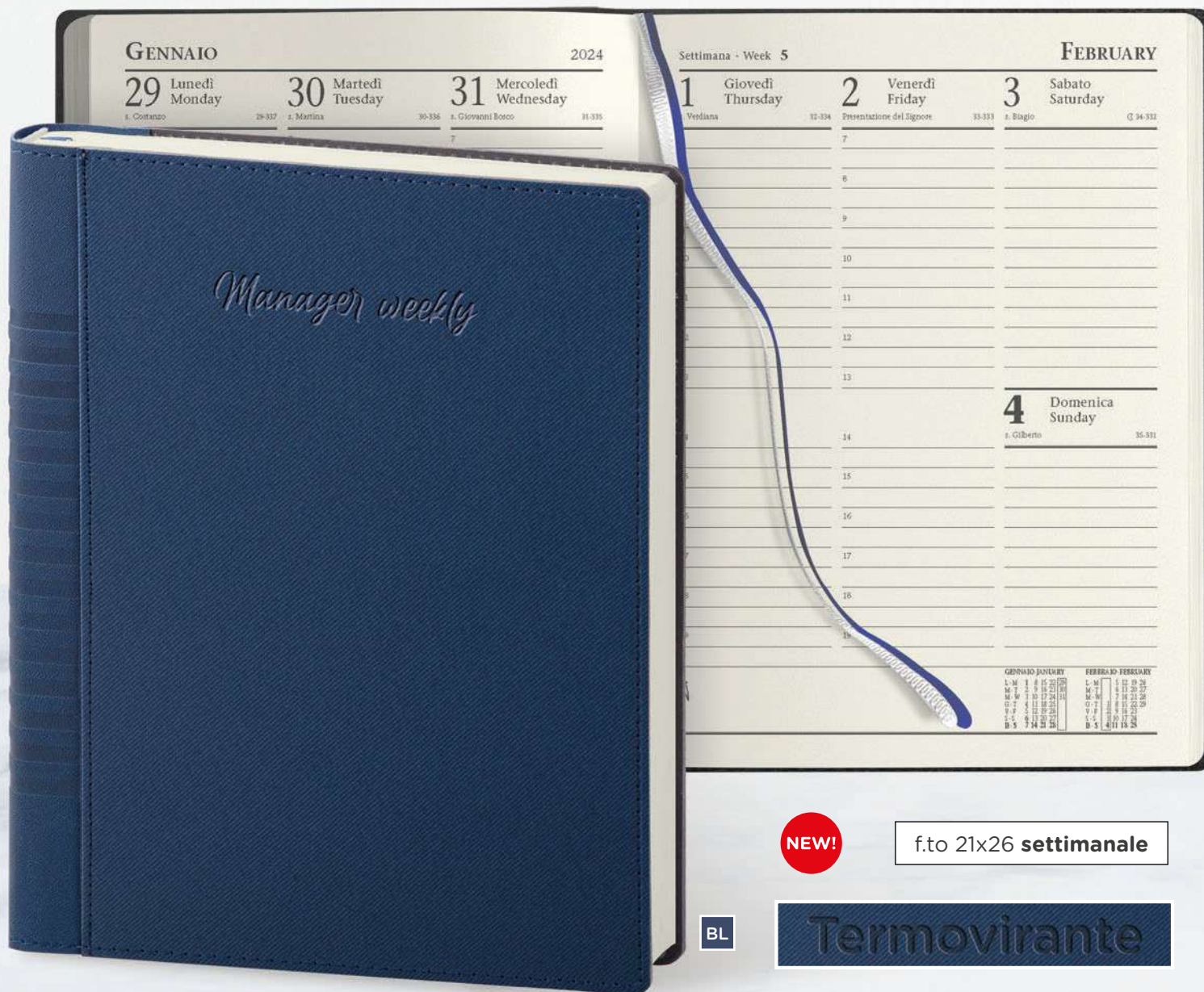

### PB266 Manager Settimanale

264 pagine carta avorio  
16 pagine inserto cartografico mondiale  
stampa a 1 colore, inserti informativi  
edizione multilingue: IT - GB  
rubrica telefonica, segnapagine doppio  
quadranti imbottiti cuciti, astuccio lusso  
materiale: poliuretano termovirante



f.to agenda: 21x26 cm ca  
1/5

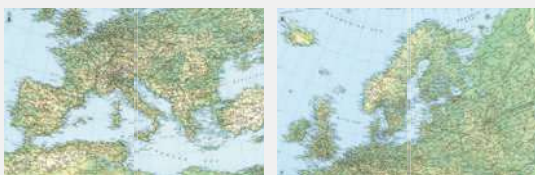

Corredata  
di astuccio

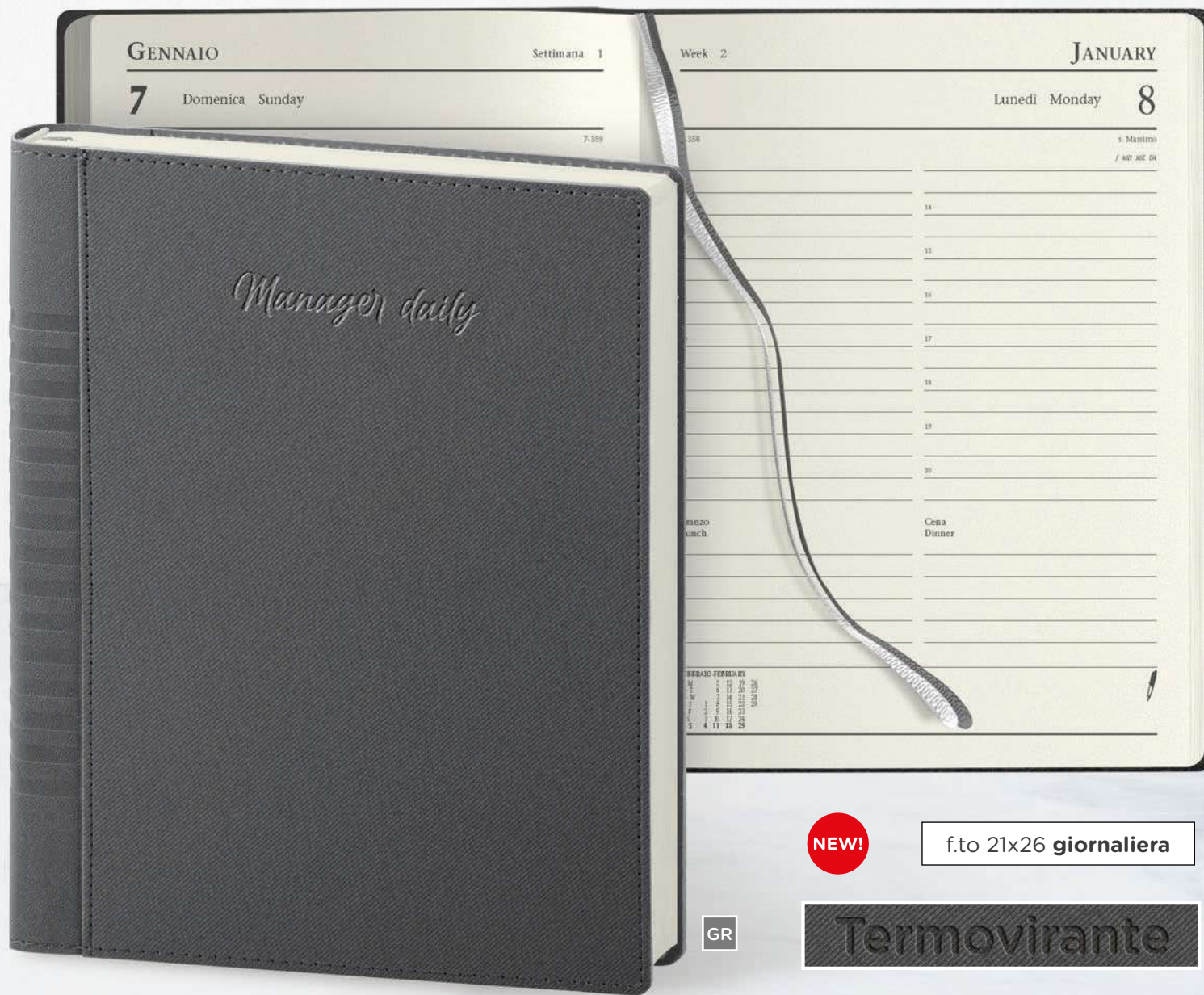

**NEW!**

f.to 21x26 **giornaliera**

GR

**Termovirante**

**PB268 Manager Giornaliera**

434 pagine carta avorio  
 16 pagine inserto cartografico mondiale  
 stampa a 1 colore, inserti informativi  
 edizione multilingue: IT - GB  
 rubrica telefonica, segnapagina doppio  
 quadranti imbottiti cuciti, astuccio lusso  
 materiale: poliuretano termovirante



f.to agenda: 21x26 cm ca  
 1/5



MA



BL



Corredata di astuccio

# Termovirante

**NEW!**
**PB239** f.to 17x24

**PB238** f.to 15x21

**BG**

**RY**

## Agende termoviranti

324 pagine sab. e dom. abbinati  
 edizione multilingue: IT - GB - FR - DE - ES - PT  
 inserti informativi e rubrica telefonica  
 inserto cartografico, segnapagina  
 chiusura magnetica  
 corredata di astuccio  
 materiale: poliuretano termovirante

 Inserto **cartografico**

**PB238** Agenda

 f.to agenda: 15x21 cm ca 20

**PB239** Maxi Agenda

 f.to agenda: 17x24 cm ca 20



BL



GR



GS



RO



SA



Chiusura con fibbia magnetica



**PB238** f.to 15x21  
sab. e dom. abbinati

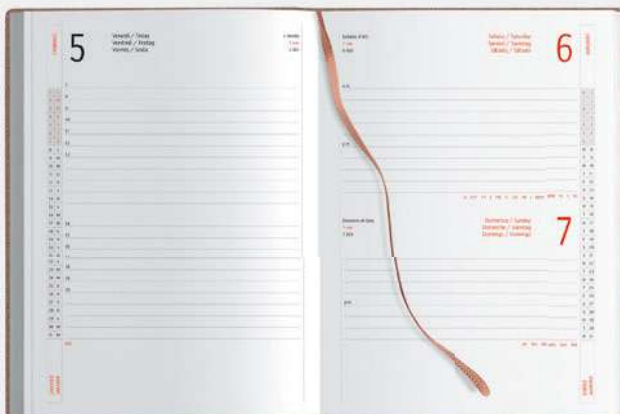

**PB239** f.to 17x24 sab. e dom. abbinati

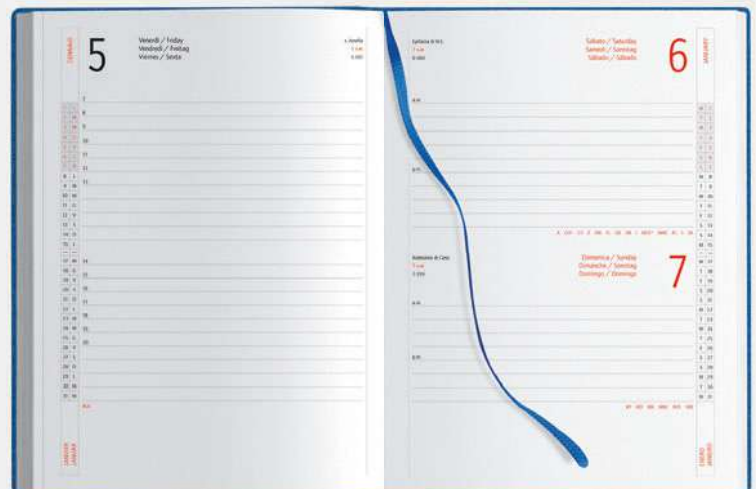

Termovirante

NEW!

PB260 f.to 17x24

PB257 f.to 15x21



GS



BL

### Agende termoviranti

324 pagine sab. e dom. abbinati  
 edizione multilingue: IT - GB - FR - DE - ES - PT  
 inserti informativi e rubrica telefonica  
 inserto cartografico, angoli tondi  
 segnapagina, chiusura magnetica, asola portapenne  
 corredata di astuccio  
 materiale: poliuretano termovirante

### Inserto cartografico



#### PB257 Agenda

f.to agenda: 15x21 cm ca  20



#### PB260 Maxi Agenda

f.to agenda: 17x24 cm ca  20





BP



MA

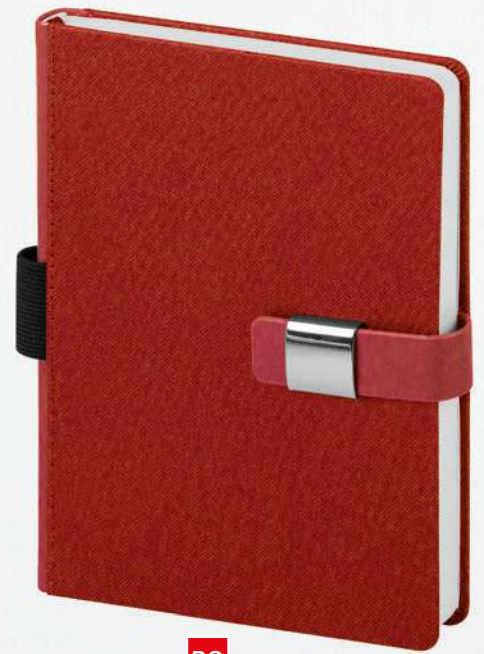

RO



Chiusura con fibbia magnetica



Asola portapenne sul dorso

**PB257** f.to 15x21  
sab. e dom. abbinati



**PB260** f.to 17x24 sab. e dom. abbinati



Termovirante

PB261 f.to 15x21



BO

PB263 f.to 17x24



BL

### Agende termoviranti

324 pagine sab. e dom. abbinati  
 edizione multilingue: IT - GB - FR - DE - ES - PT  
 inserti informativi e rubrica telefonica  
 inserto cartografico, quadranti imbottiti angoli tondi  
 segnapagina, chiusura magnetica  
 tasca anteriore porta cellulare/penna  
 corredata di astuccio  
 materiale: poliuretano termovirante

### Inserto cartografico



**PB261** Agenda

☑ f.to agenda: 15x21 cm ca 📦 20



**PB263** Maxi Agenda

☑ f.to agenda: 17x24 cm ca 📦 20



GR

NE



VE



**PB261** f.to 15x21  
sab. e dom. abbinati



**PB263** f.to 17x24 sab. e dom. abbinati

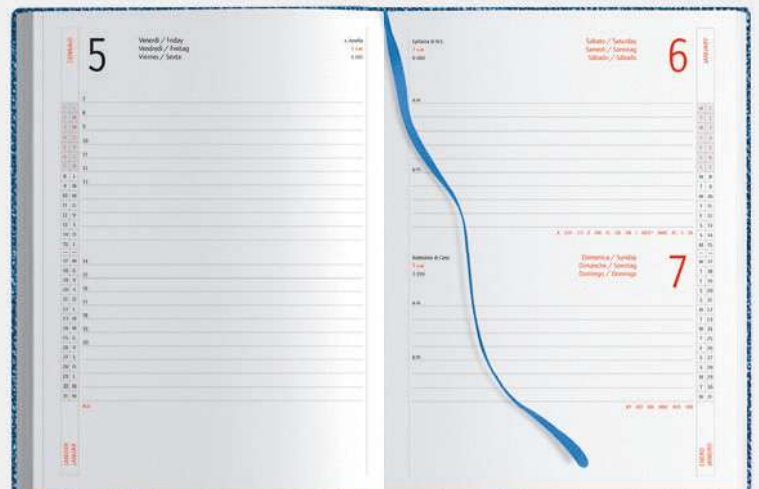

PB265 f.to 15x21

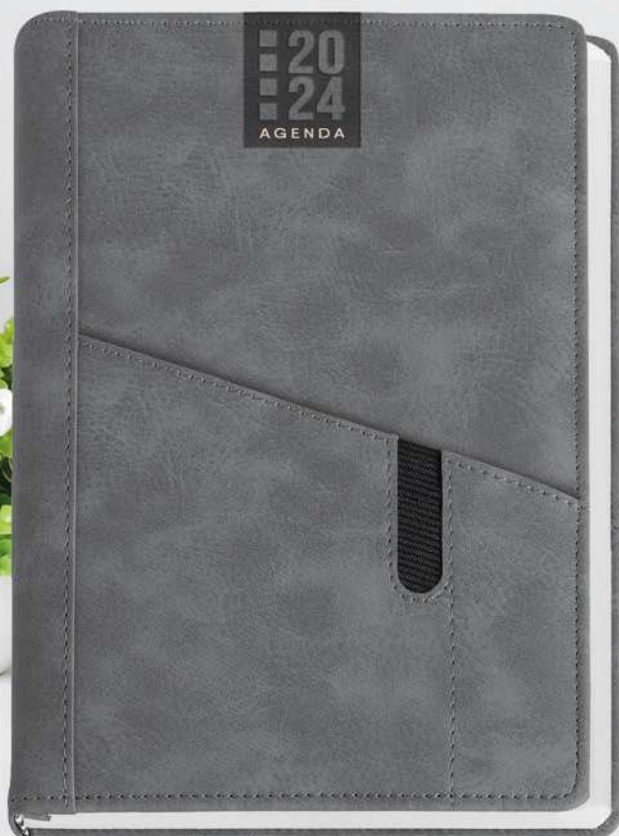

GR

PB270 f.to 17x24



CU

## Insero cartografico

**Agende con tasca**

324 pagine sab. e dom. abbinati  
 edizione multilingue: IT - GB - FR - DE - ES - PT  
 inserti informativi e rubrica telefonica, segnapagine  
 inserto cartografico, quadranti imbottiti angoli tondi  
 2 tasche anteriori porta cellulare/penna  
 materiale: poliuretano

**PB265** Agenda

f.to agenda: 15x21 cm ca  20

**AS010** Astuccio su richiesta

**PB270** Maxi Agenda

f.to agenda: 17x24 cm ca  20

**AS020** Astuccio su richiesta



**PB265** f.to 15x21  
sab. e dom. abbinati

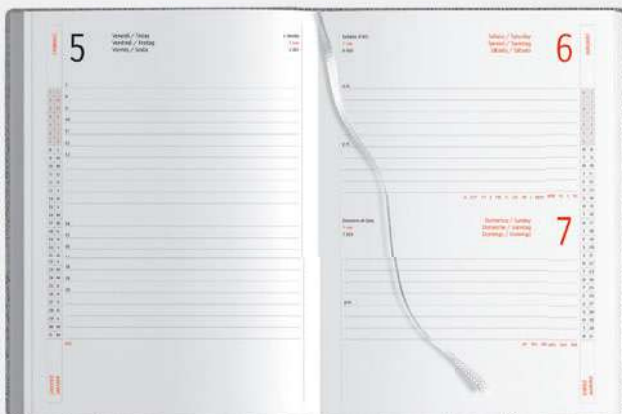

**PB270** f.to 17x24 sab. e dom. abbinati



# Termovirante

PB275 f.to 15x21

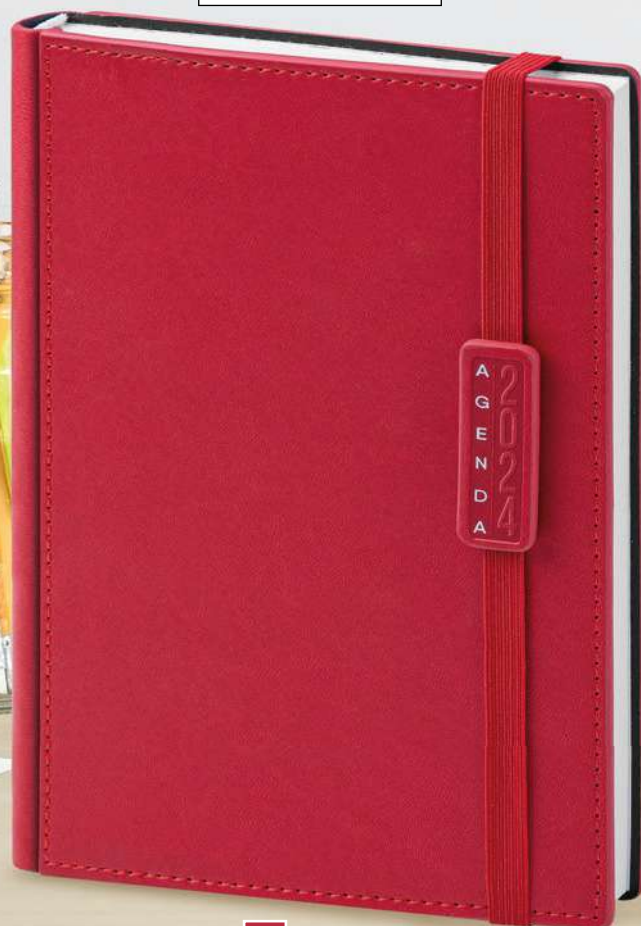

RO

NEW!

PB278 f.to 17x24

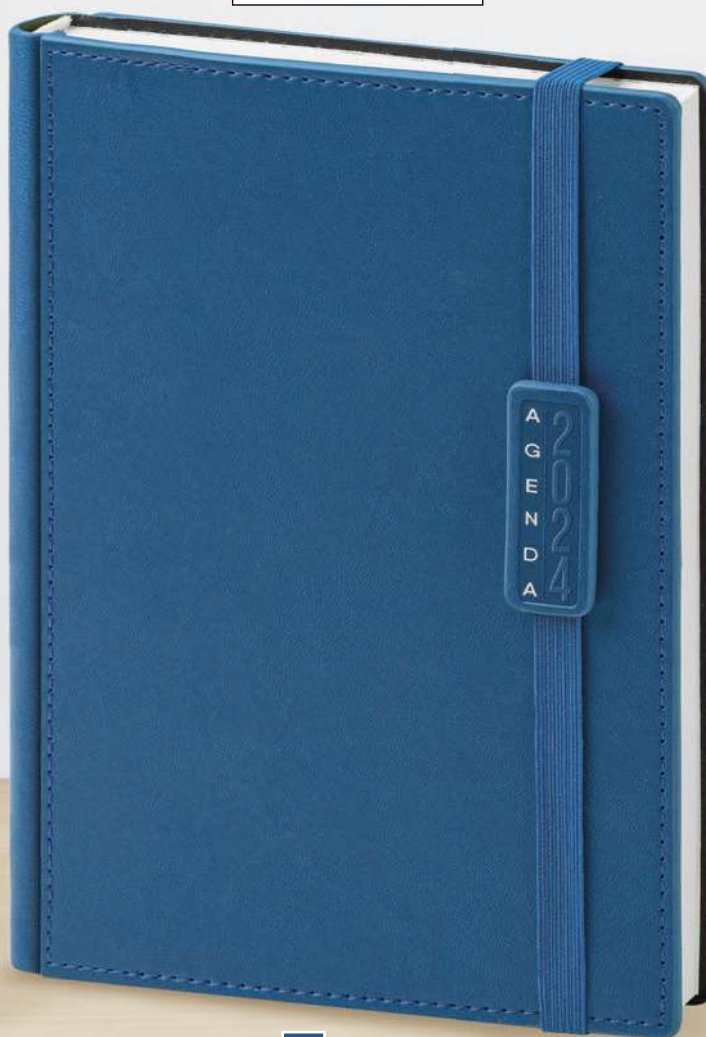

BL

## Agende termoviranti

324 pagine sab. e dom. abbinati  
 edizione multilingue: IT - GB - FR - DE - ES - PT  
 inserti informativi e rubrica telefonica, segnapagina  
 quadranti angoli tondi, inserto cartografico  
 chiusura con elastico, corredata di astuccio  
 materiale: poliuretano termovirante

### Inserto cartografico



**PB275** Agenda

☑ f.to agenda: 15x21 cm ca 📦 20



**PB278** Maxi Agenda

☑ f.to agenda: 17x24 cm ca 📦 20

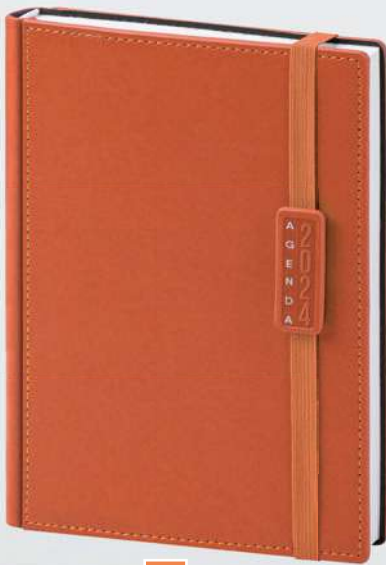

AR



AZ



CU

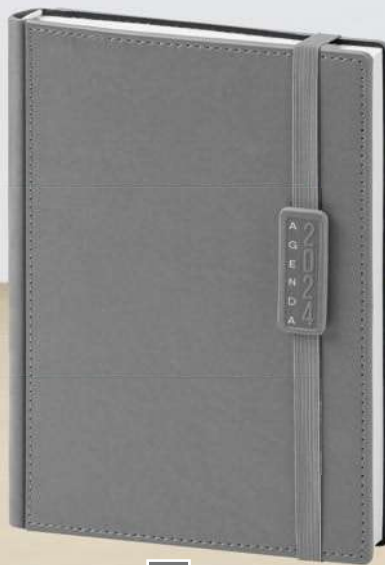

GR



Bordo in colore abbinato

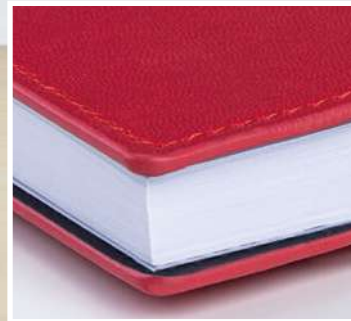

**PB275** f.to 15x21  
sab. e dom. abbinati



**PB278** f.to 17x24 sab. e dom. abbinati



# Termovirante

NEW!

PB282 f.to 17x24

PB280 f.to 15x21

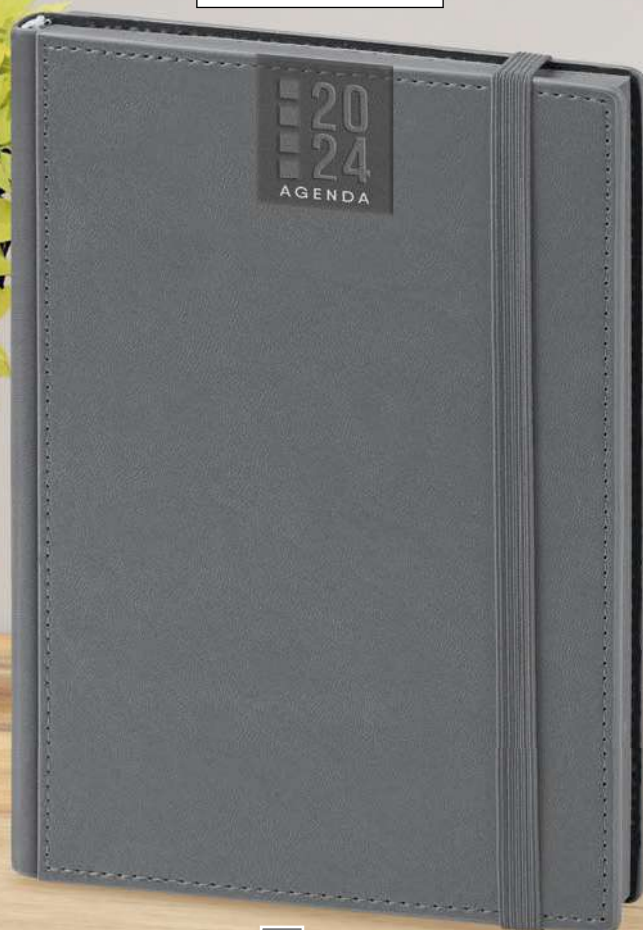

GR

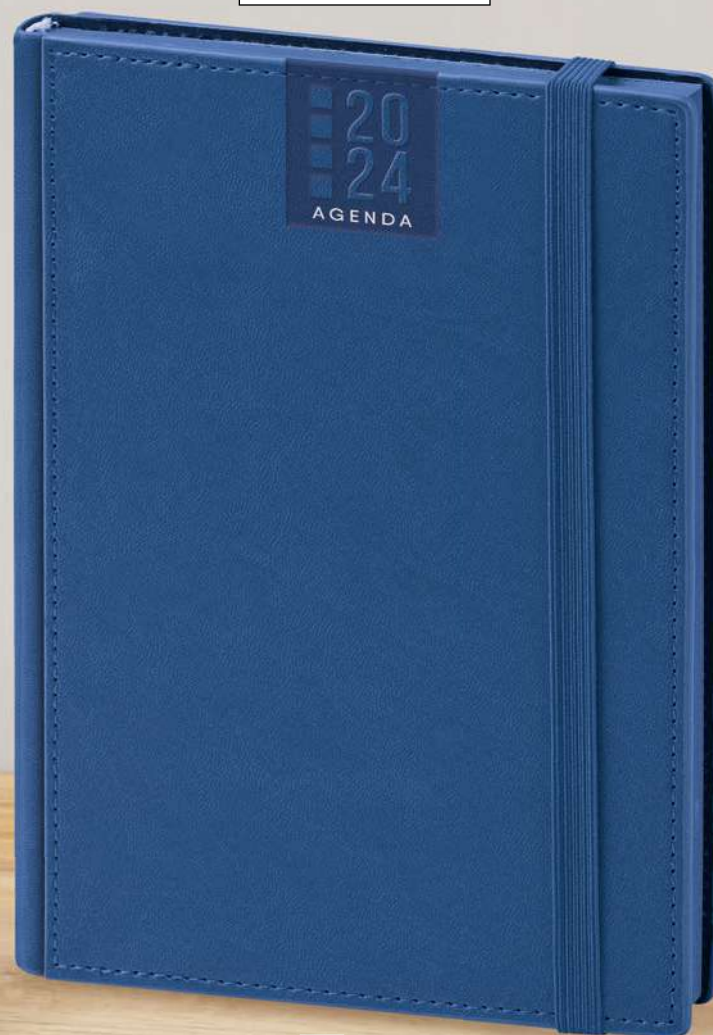

BL

## Agende termoviranti

324 pagine sab. e dom. abbinati  
 edizione multilingue: IT - GB - FR - DE - ES - PT  
 inserti informativi e rubrica telefonica  
 quadranti angoli tondi, inserto cartografico  
 segnapagina, chiusura con elastico  
 materiale: poliuretano termovirante

## Inserto cartografico



**PB280** Agenda

☑ f.to agenda: 15x21 cm ca 📦 20



**PB282** Maxi Agenda

☑ f.to agenda: 17x24 cm ca 📦 20



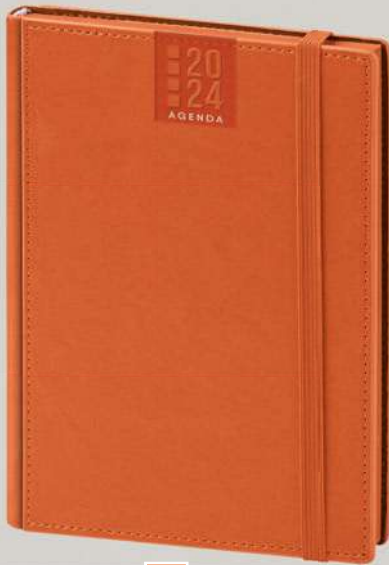

AR

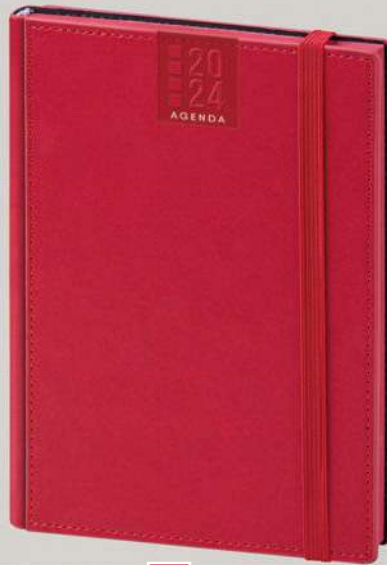

RO

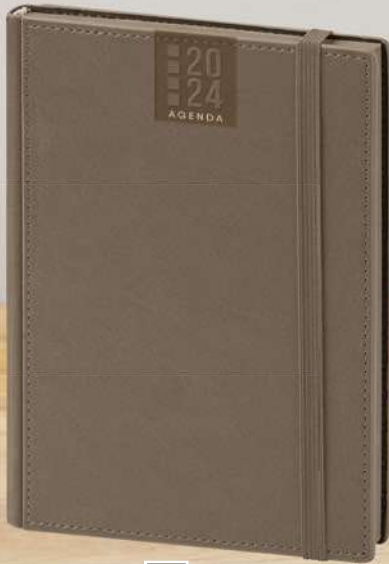

TA

Bordo in colore abbinato

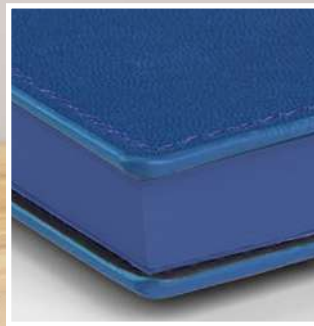

**PB280** f.to 15x21  
sab. e dom. abbinati



**PB282** f.to 17x24 sab. e dom. abbinati



PB283 f.to 15x21

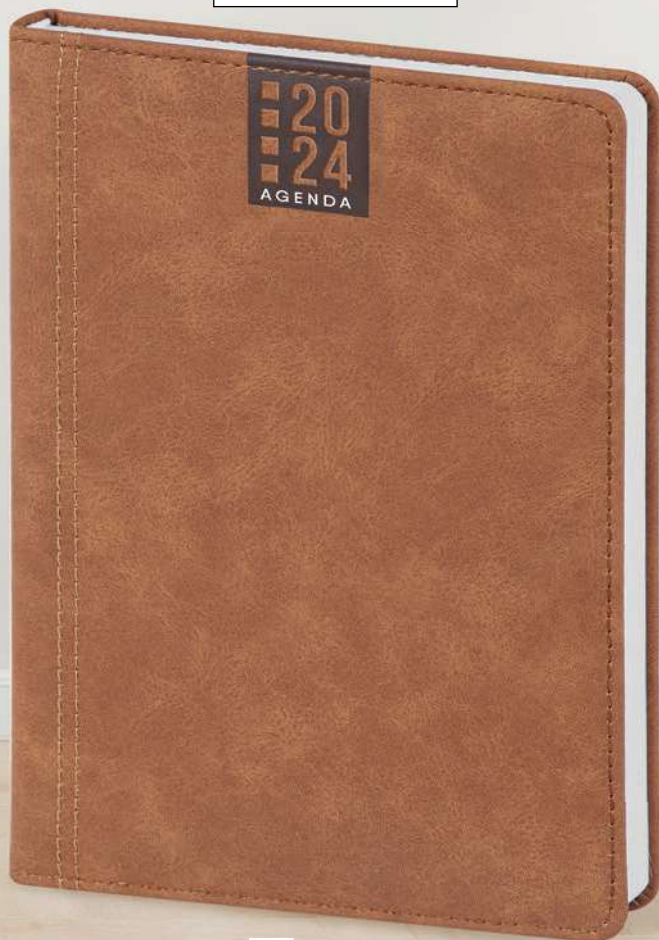

CU

PB286 f.to 17x24

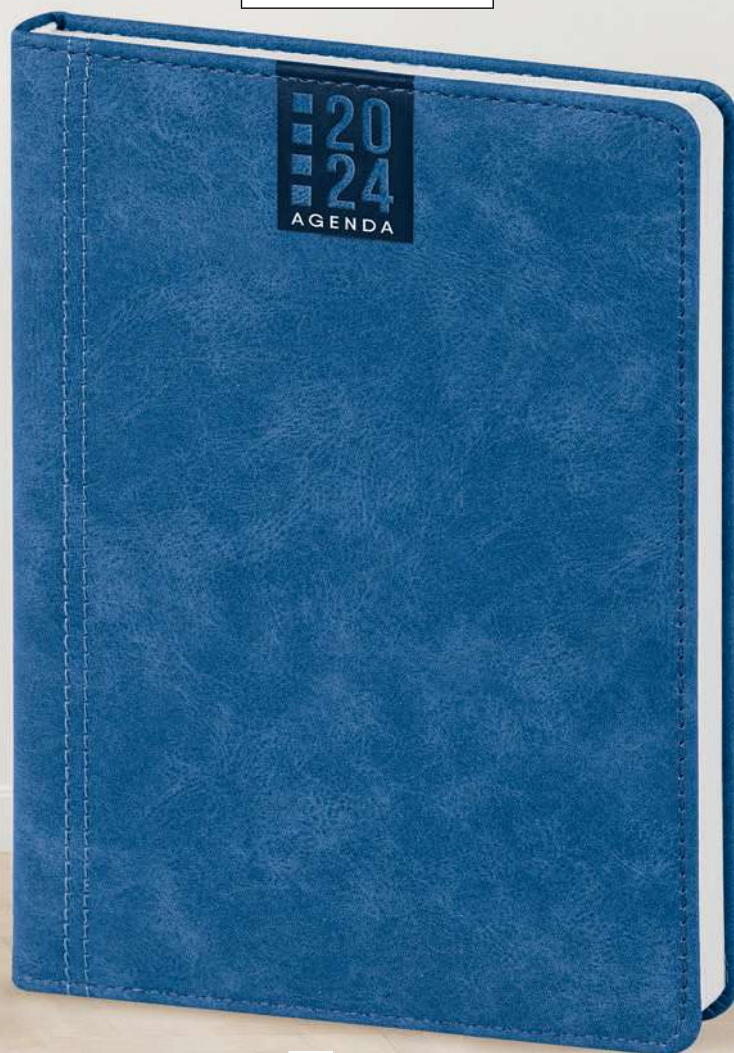

RY

### Agende giornaliera

324 pagine sab. e dom. abbinati  
 edizione multilingue: IT - GB - FR - DE - ES - PT  
 segnapagina, quadranti imbottiti  
 inserti informativi e rubrica telefonica, angoli tondi  
 inserto cartografico, materiale: poliuretano



#### PB283 Agenda

f.to agenda: 15x21 cm ca  20

**AS010** Astuccio su richiesta

### Inserto cartografico



#### PB286 Maxi Agenda

f.to agenda: 17x24 cm ca  20

**AS020** Astuccio su richiesta

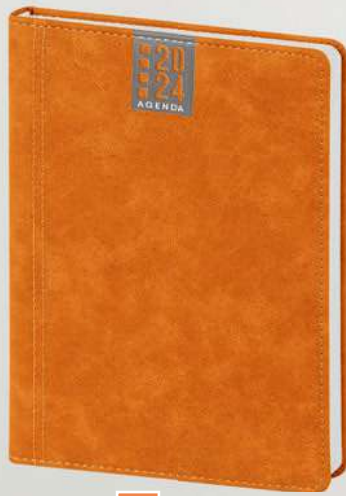

AR

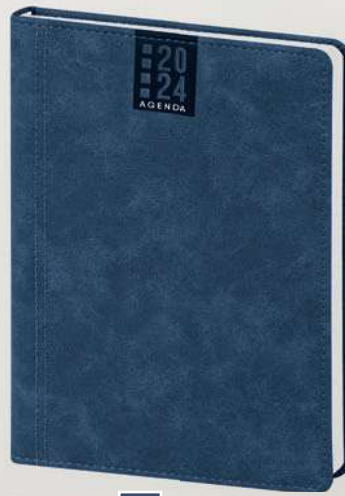

BL

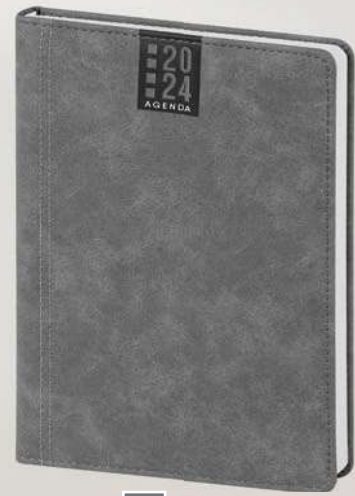

GR

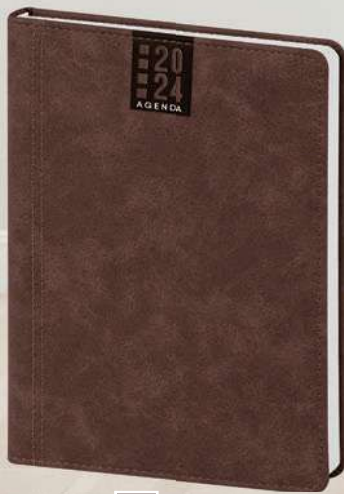

MA

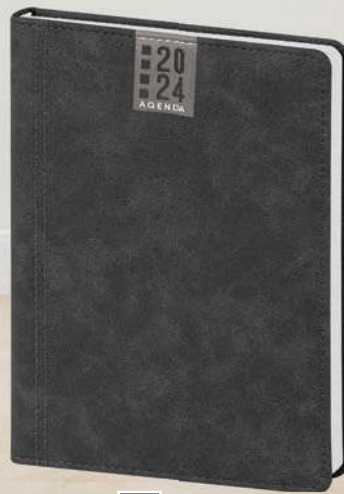

NE

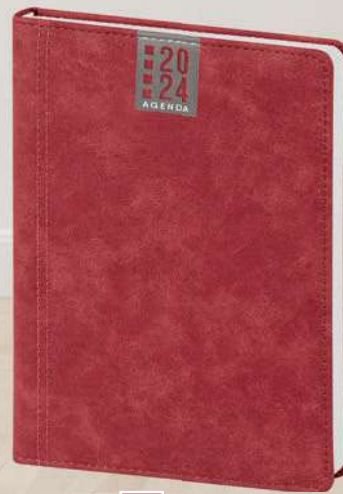

RO

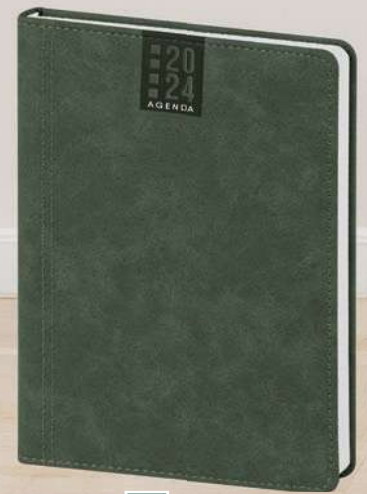

VE

**PB283** f.to 15x21  
sab. e dom. abbinati



**PB286** f.to 17x24 sab. e dom. abbinati



NEW!

PB284 f.to 14,5x21 settimanale



NEW!

PB285 f.to 14,5x21 giornaliera

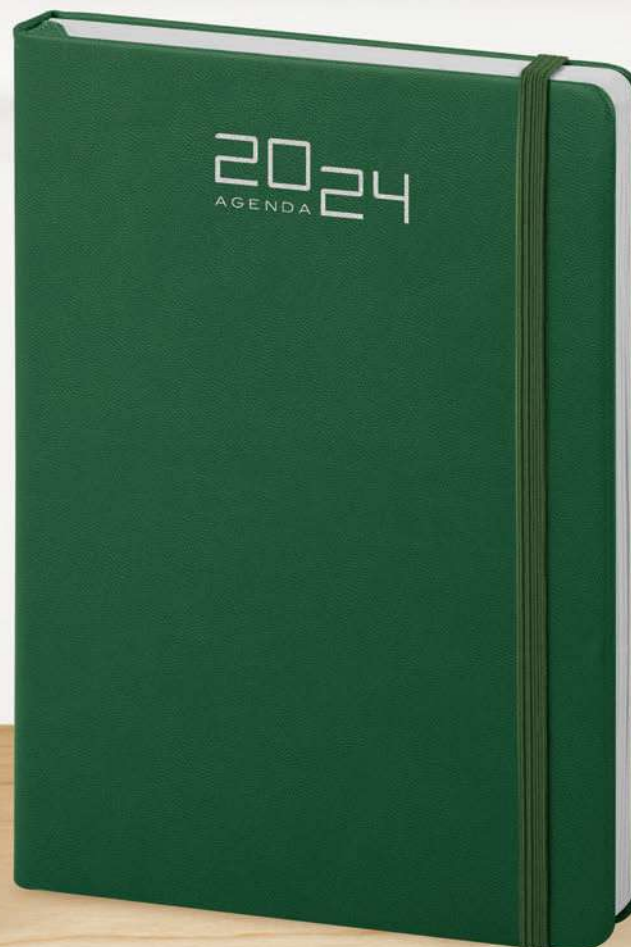

### Agende in PU

edizione multilingue:

IT - GB - FR - DE - ES - PT

elastico e segnapagina in tinta

inserti informativi e rubrica telefonica

angoli tondi

materiale: PU



#### **PB284** Agenda Settimanale

128 pag. settimanali

f.to agenda: 14,5x21 cm ca  40



#### **PB285** Agenda Giornaliera

320 pag. sab. e dom. abbinati

f.to agenda: 14,5x21 cm ca  40

**AS010** Astuccio su richiesta



AR

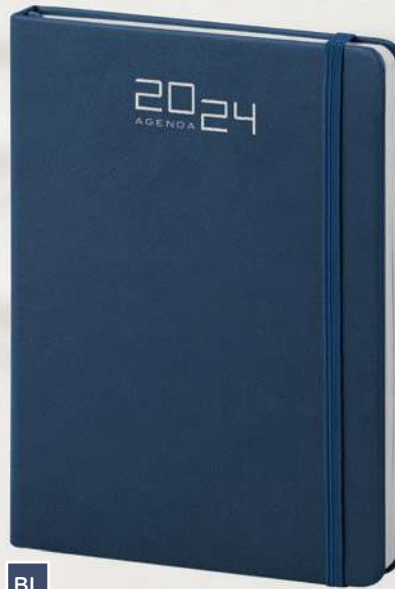

BL

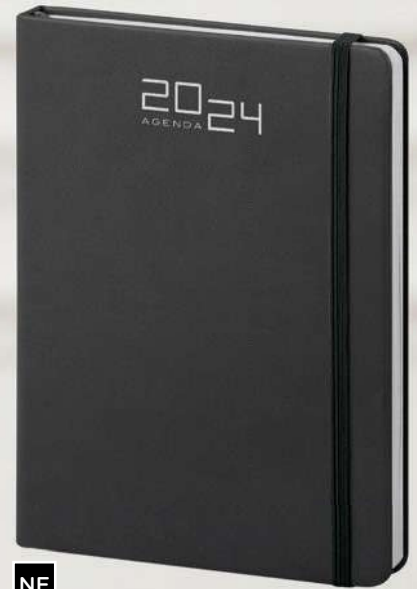

NE



RO



RY

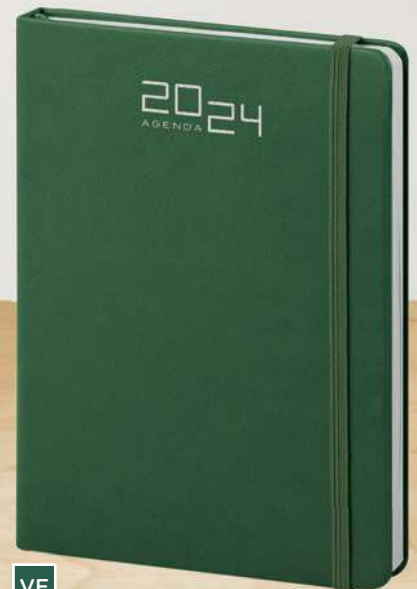

VE

PB284 settimanale



PB285 sab. e dom. abbinati



**PB281** Agenda Tascabile Bi-Giornaliera

160 pagine bi-giornaliera, edizione bilingue: IT - GB, elastico e segnapagina in tinta calendario 2024, pagina dati personali, angoli tondi, materiale: PU



f.to agenda: 9x14 cm ca  
20/80

**AS046** Astuccio su richiesta



interno bi-giornaliero f.to 9x14

RO

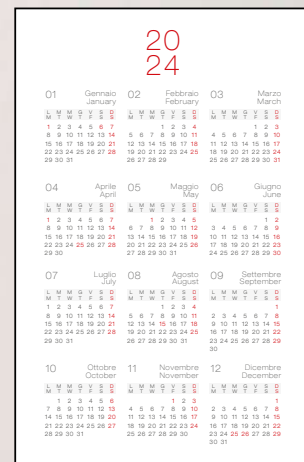

Calendario 2024

**2024**

**Note personali**  
Personal data

Nome e cognome  
Nome and surname

Indirizzo  
Address

Numero di telefono  
Telephone number

E-mail

Codice fiscale IV  
Income tax code IV

Carta d'identità  
ID

Passaporto  
No. Passport

Paese nato  
Registration state

Libretto di circolazione  
Lic. lic. no.

Patente  
Driving licence

Dati medici  
Medical data

Gruppo sanguigno  
Blood group

Allegati  
Attachments

**In caso di necessità comunicare a  
In case of accident please notify**

Nome e cognome  
Nome and surname

Indirizzo  
Address

Numero di telefono  
Telephone number

Dati Personali



AR



BL



NE



RY



VE

### PB287 Agenda Tascabile Settimanale

128 pagine settimanali, edizione multilingue, segnapagina  
chiusura con elastico, pagine note, turnario del lavoratore, materiale: PU



f.to agenda: 9x14 cm ca  
80

AS046 Astuccio su richiesta



interno settimanale f.to 9x14

BL

**Turnario del lavoratore 2024**

GENNAIO JANUARY	PRESENZE									
	GIORNATA	TURNO	GIORNATA LAVORO	MASSIMA PUNTA	PERI PERI	PERI PERI	PERI PERI	PERI PERI	PERI PERI	PERI PERI
1	Lunedì									
2	Marcoledì									
3	Mercoledì									
4	Giovedì									
5	Venerdì									
6	Sabato									
7	Domenica									
8	Lunedì									
9	Marcoledì									
10	Mercoledì									
11	Giovedì									
12	Venerdì									
13	Sabato									
14	Domenica									
15	Lunedì									
16	Marcoledì									
17	Mercoledì									
18	Giovedì									
19	Venerdì									
20	Sabato									
21	Domenica									
22	Lunedì									
23	Marcoledì									
24	Mercoledì									
25	Giovedì									
26	Venerdì									
27	Sabato									
28	Domenica									
29	Lunedì									
30	Marcoledì									
31	Mercoledì									

Turnario del lavoratore 2024



Pagine note a fine agenda



AR



NE



RO



RY



VE

NEW!

PB288 f.to 15x21 giornaliera

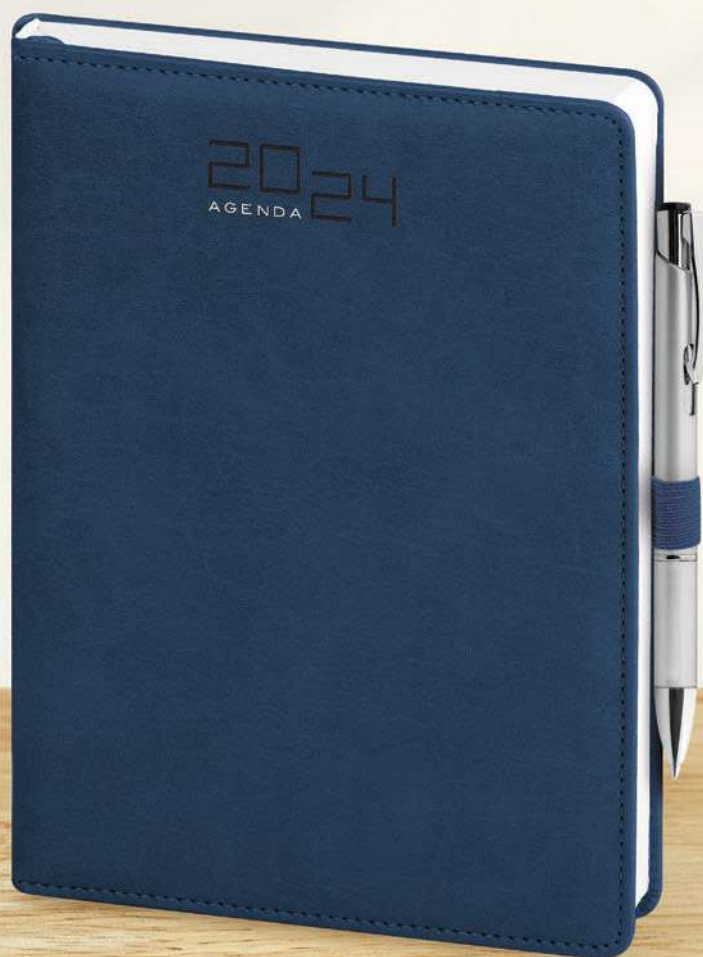

NEW!

PB290 f.to 12x17 giornaliera

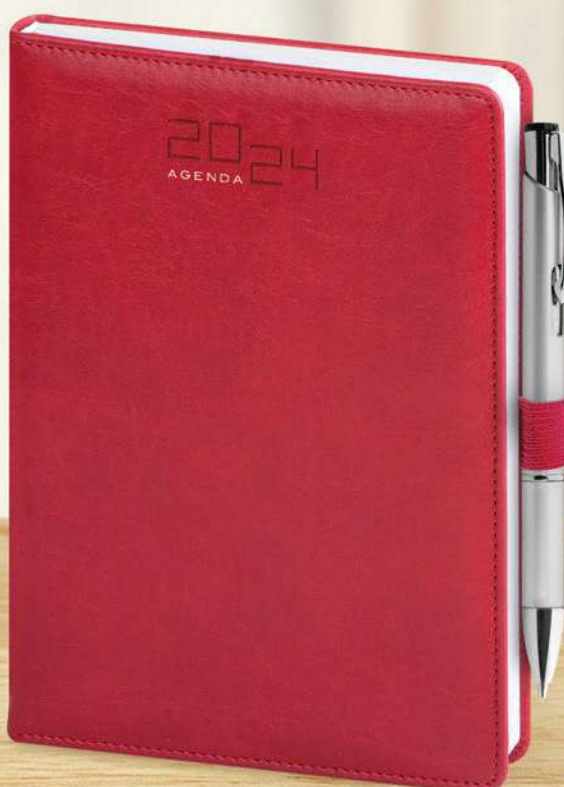

### Agende in PU

320 pag. sab. e dom. abbinati  
 edizione multilingue:  
 IT - GB - FR - DE - ES - PT  
 inserti informativi e rubrica telefonica  
 angoli tondi, elastico portapenna in tinta  
 materiale: PU termovirante



**PB288** Agenda Giornaliera

☑ f.to agenda: 15x21 cm ca 📦 20

**AS010** Astuccio su richiesta



**PB290** Agenda Giornaliera

☑ f.to agenda: 12x18 cm ca 📦 20

**AS090** Astuccio su richiesta



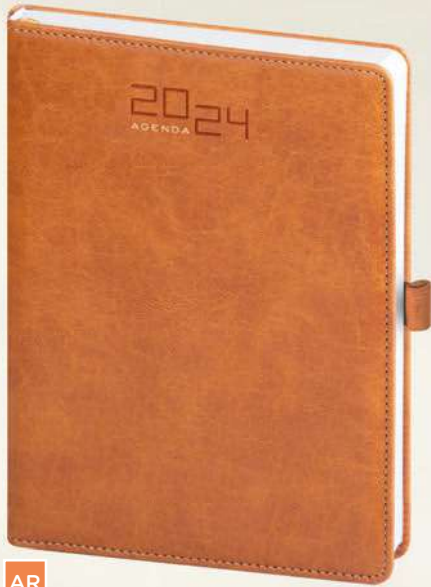

AR

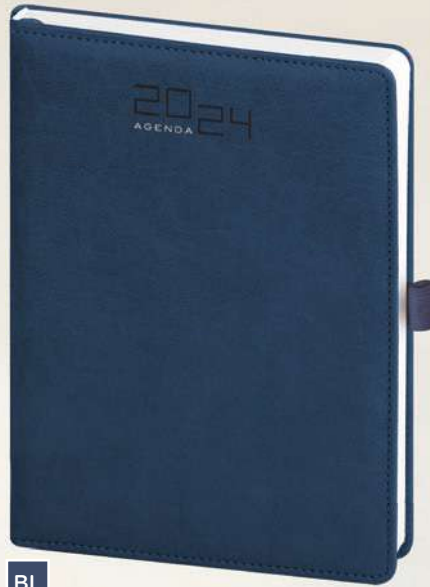

BL

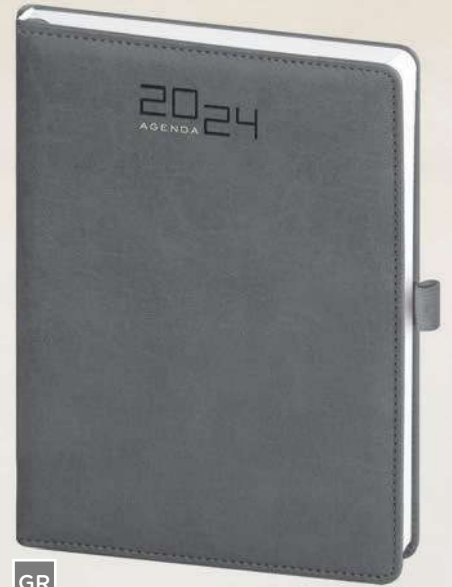

GR



RO



RY

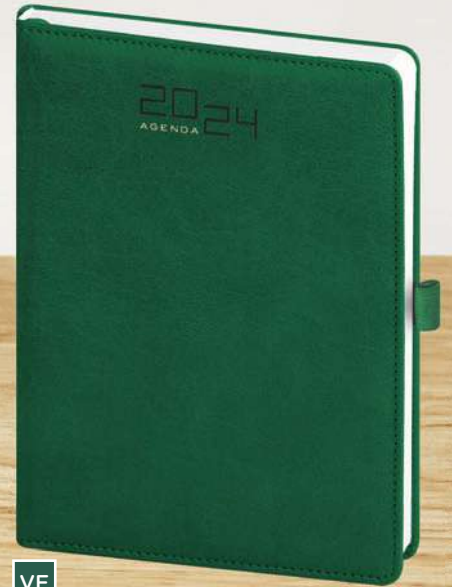

VE

PB288 f.to 15x21 giornaliera

PB290 f.to 12x18 giornaliera



**PB289** Agenda Tascabile Settimanale

128 pagine, edizione multilingue: IT - GB- FR- DE - ES - PT

inserti informativi e rubrica telefonica, angoli tondi, elastico e portapenna in tinta  
segnapagina in tinta, materiale: PU termovirante

f.to agenda: 9x14 cm ca

100

**AS046** Astuccio su richiesta

interno settimanale f.to 9x14

VE

Termovirante



AR

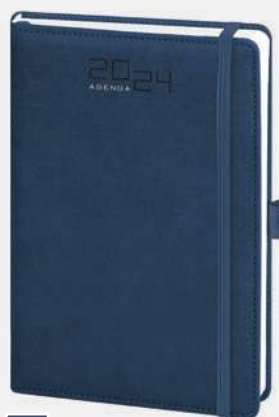

BL



GR

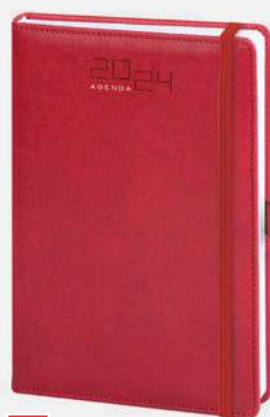

RO



RY



**PB320** Maxi Agenda

324 pag. sab. e dom. abbinati  
 edizione multilingue: IT - GB- FR- DE - ES - PT  
 inserti informativi e rubrica telefonica  
 inserto cartografico, segnapagina  
 materiale: poliuretano termovirante



f.to agenda: 17x24 cm ca  
 20

**AS033** Astuccio su richiesta

**Termovirante**

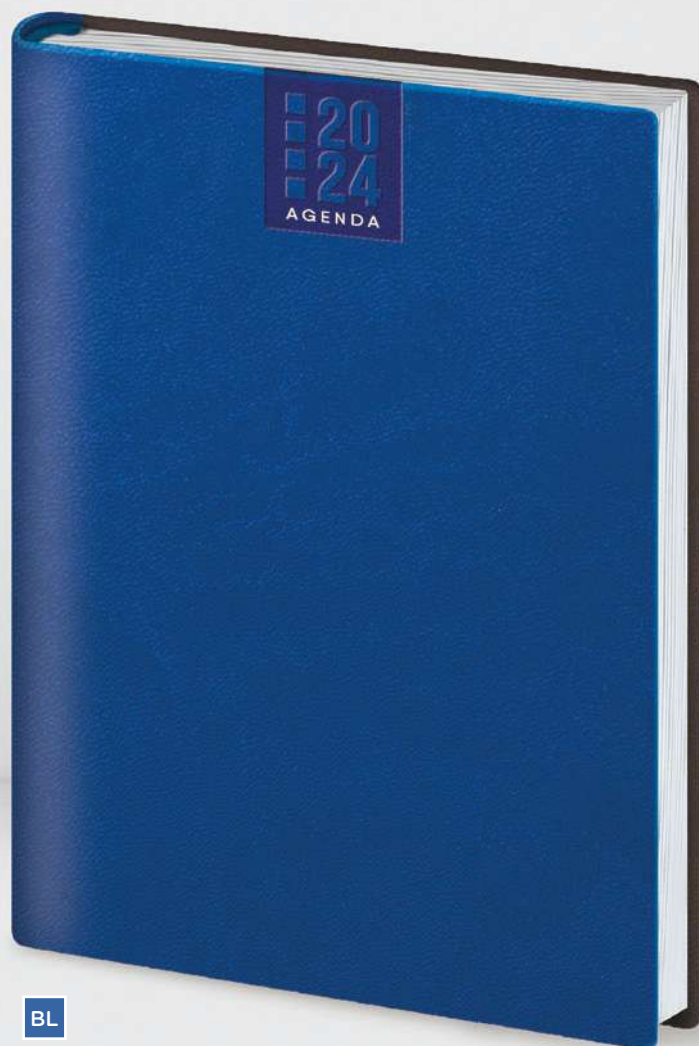
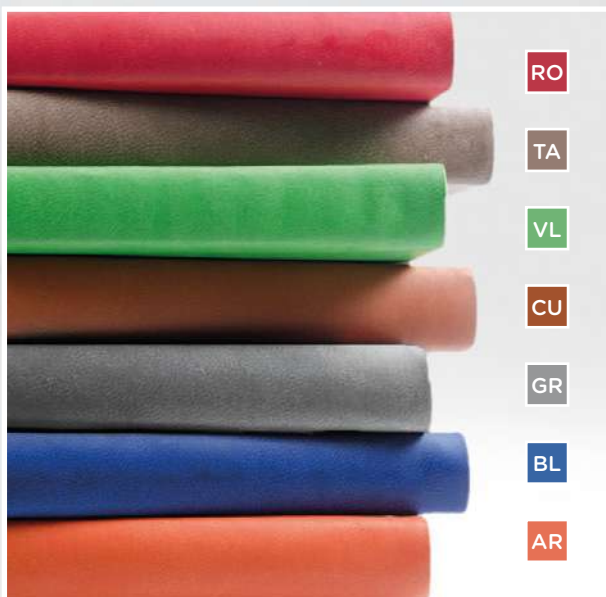

BL

Quadrante **Flessibile**

**Interno sabato  
 e domenica abbinati**  
 f.to 17x24



Inserto **cartografico**



**PB330** Agenda

324 pag. sab. e dom. abbinati  
 edizione multilingue: IT - GB- FR- DE - ES - PT  
 inserti informativi e rubrica telefonica  
 inserto cartografico, segnapagina  
 materiale: poliuretano termovirante



f.to agenda: 15x21 cm ca  
 20

**AS010** Astuccio su richiesta

**Termovirante**



Quadrante **Flessibile**

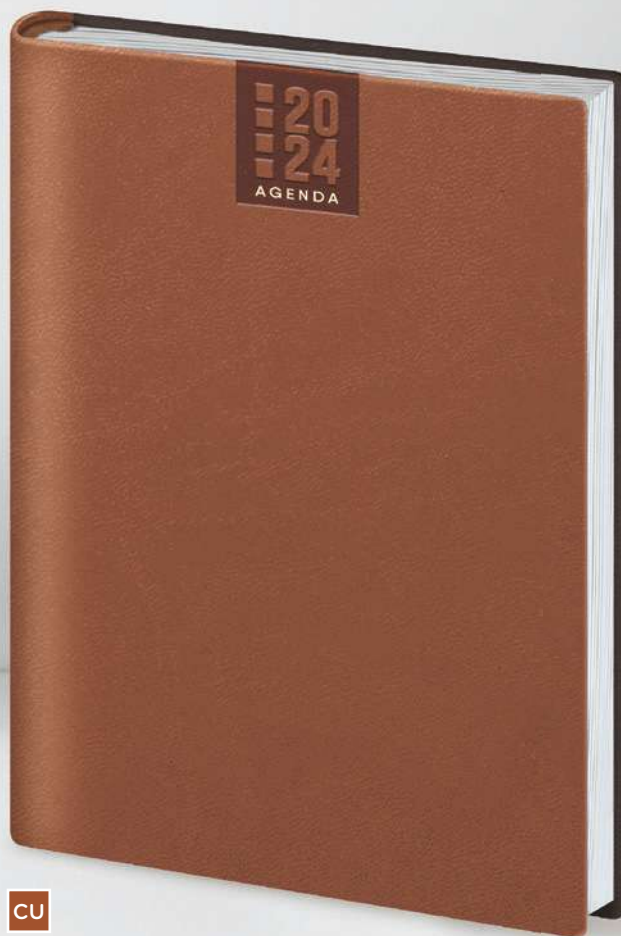

**Interno sabato e domenica abbinati**  
 f.to 15x21



Inserto **cartografico**

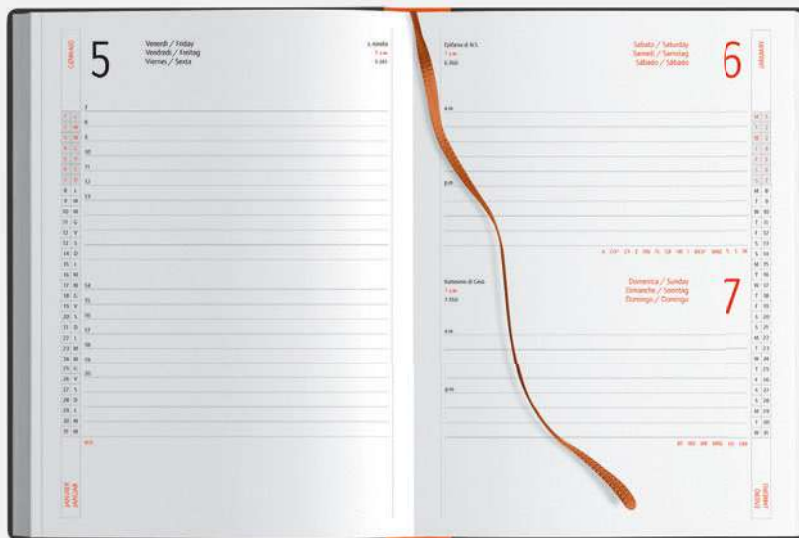

**PB340** Maxi Agenda

132 pagine  
 edizione multilingue: IT - GB - FR- DE - ES - PT  
 inserti informativi e rubrica telefonica  
 inserto cartografico, segnapagina  
 materiale: poliuretano termovirante



f.to agenda: 17x24 cm ca  
 30

**AS030** Astuccio su richiesta

## Termovirante

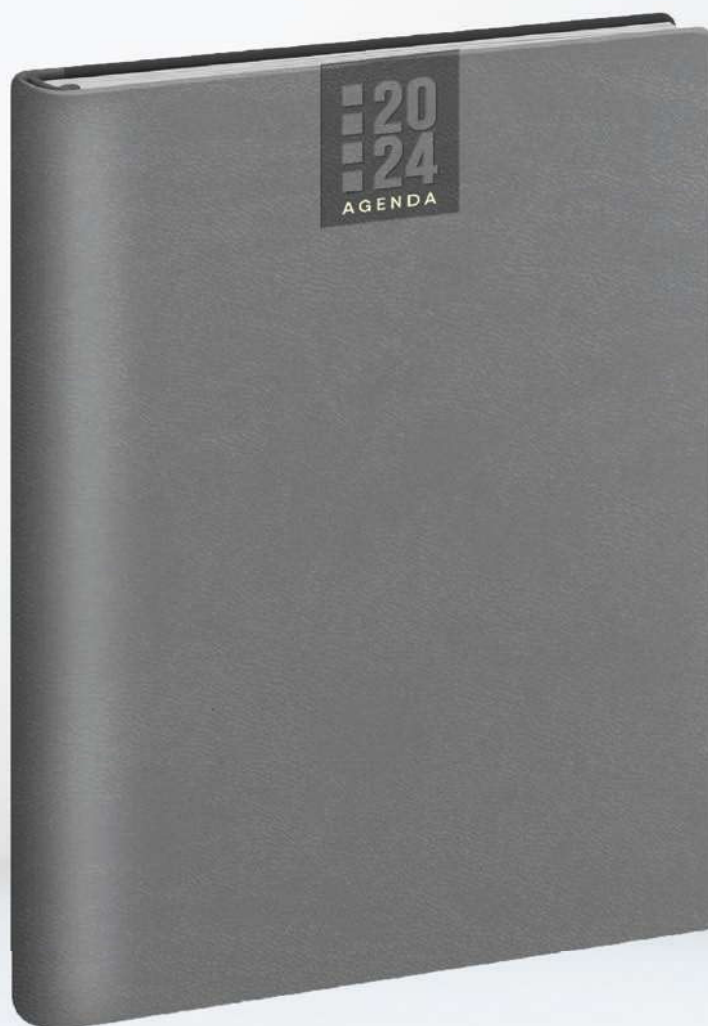

GR

Quadrante Flessibile

**Interno settimanale**  
 f.to 17x24

Inserto cartografico



### PB351 Agenda Tascabile

136 pagine, edizione multilingue: IT - GB- FR- DE - ES - PT  
 inserti informativi e rubrica telefonica, inserto cartografico  
 elastico in tinta, materiale: poliuretano termovirante



f.to agenda: 9x15 cm ca  
 100

AS043 Astuccio su richiesta

**NEW!** Nuovo formato  
 cm 9x15 ca



Quadrante **Flessibile**

**Termovirante**

BL



AR



CU



GR



RO



TA



VL

### Interno settimanale f.to 9x15



Inserto **cartografico**

Turnario del lavoratore 2024										Turnario del lavoratore 2024													
GENNAIO		PRESENZE		TORNARE		LAVORO		RIPRESENTAZIONE		RIPRESENTAZIONE		FEBBRAIO		PRESENZE		TORNARE		LAVORO		RIPRESENTAZIONE		RIPRESENTAZIONE	
GIORNO	ORA	GIORNO	ORA	GIORNO	ORA	GIORNO	ORA	GIORNO	ORA	GIORNO	ORA	GIORNO	ORA	GIORNO	ORA	GIORNO	ORA	GIORNO	ORA	GIORNO	ORA	GIORNO	ORA
1	Lunedì											1	Giovedì										
2	Martedì											2	Venerdì										
3	Mercoledì											3	Sabato										
4	Giovedì											4	Domenica										
5	Venerdì											5	Lunedì										
6	Sabato											6	Martedì										
7	Domenica											7	Mercoledì										
8	Lunedì											8	Giovedì										
9	Martedì											9	Venerdì										
10	Mercoledì											10	Sabato										
11	Giovedì											11	Domenica										
12	Venerdì											12	Lunedì										
13	Sabato											13	Martedì										
14	Domenica											14	Mercoledì										
15	Lunedì											15	Giovedì										
16	Martedì											16	Venerdì										
17	Mercoledì											17	Sabato										
18	Giovedì											18	Domenica										
19	Venerdì											19	Lunedì										
20	Sabato											20	Martedì										
21	Domenica											21	Mercoledì										
22	Lunedì											22	Giovedì										
23	Martedì											23	Venerdì										
24	Mercoledì											24	Sabato										
25	Giovedì											25	Domenica										
26	Venerdì											26	Lunedì										
27	Sabato											27	Martedì										
28	Domenica											28	Mercoledì										
29	Lunedì											29	Giovedì										
30	Martedì											30	Venerdì										
31	Mercoledì											31	Sabato										

Turnario del lavoratore **2024**

PB375 f.to 15x21

PB380 f.to 17x24

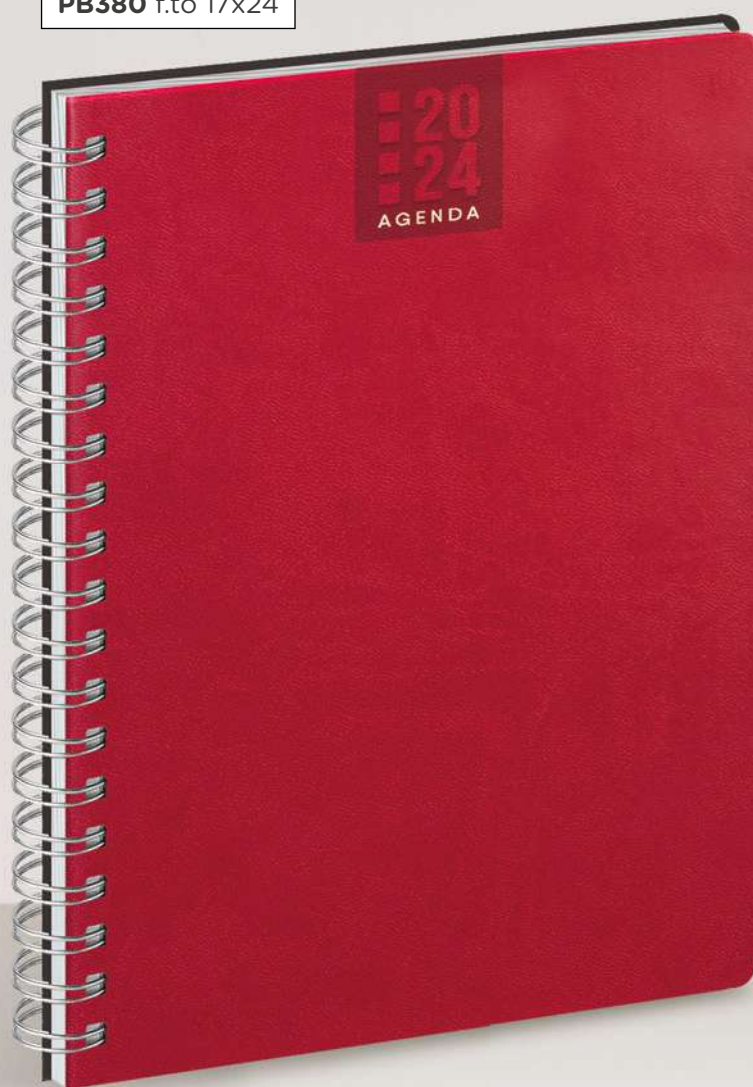
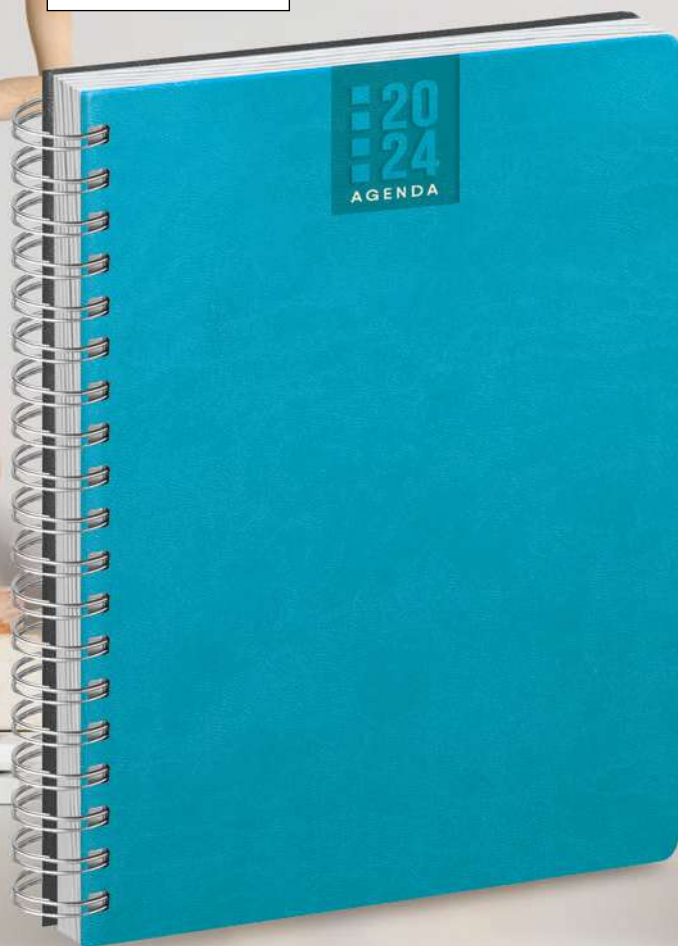

### Agende Spiralate

edizione multilingue: IT - GB - FR - DE - ES - PT - SE  
 NL - RU - ARABO - CN - JP  
 inserti informativi e rubrica telefonica, inserto cartografico  
 angolo segnapagina perforato, corredate di astuccio  
 materiale: poliuretano termovirante



Angolo  
 segnapagina  
 perforato



#### PB375 Agenda

336 pag. sab. e dom. abbinati  
 f.to agenda: 15x21 cm ca  20



#### PB380 Maxi Agenda

128 pagine settimanali  
 f.to agenda: 17x24 cm ca  20

Termovirante

Termovirante





AR



AZ



BL



RO



TA



VL

**PB375** f.to 15x21  
Interno giornaliero

**PB380** f.to 17x24 Interno settimanale

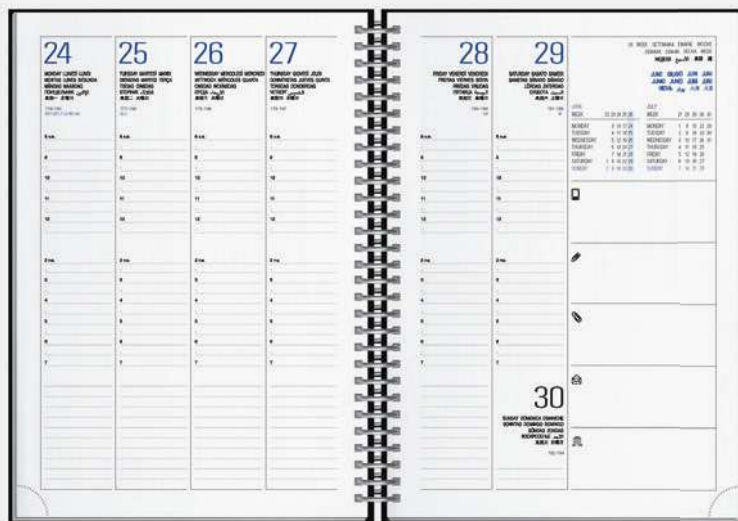
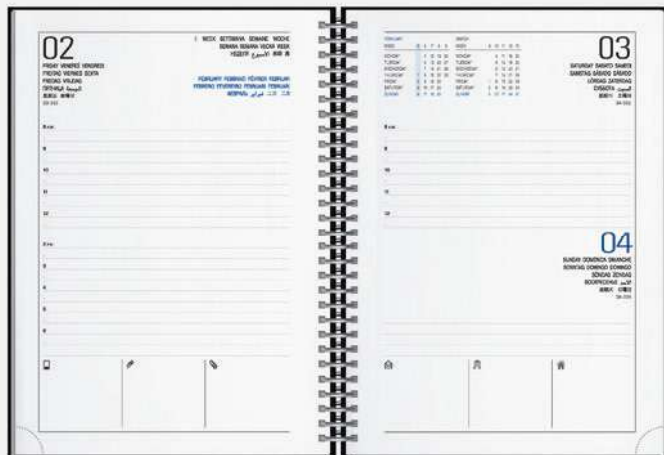

CALAMUS®

PB355 settimanale

NEW!

NEW!

PB356 bi-giornaliera

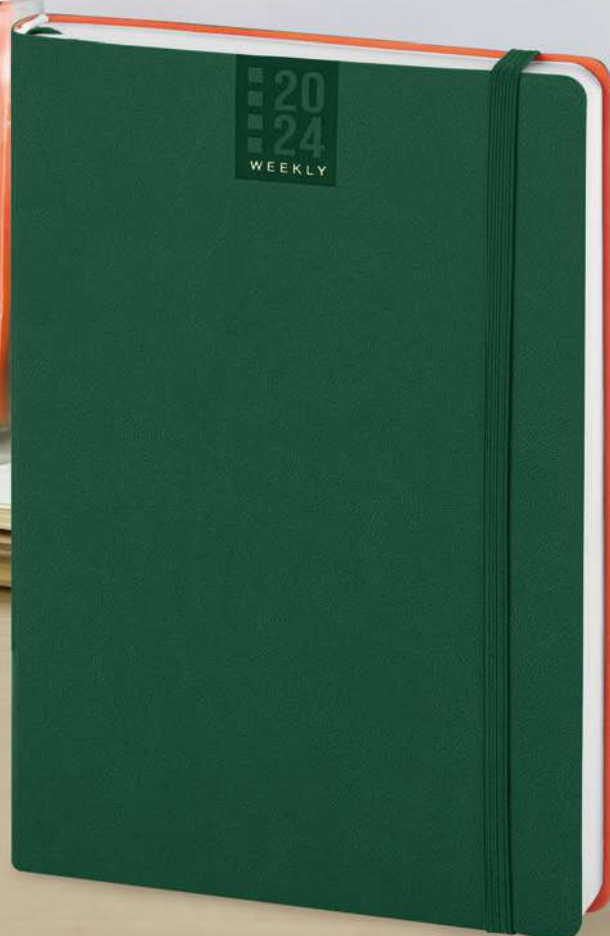

VE

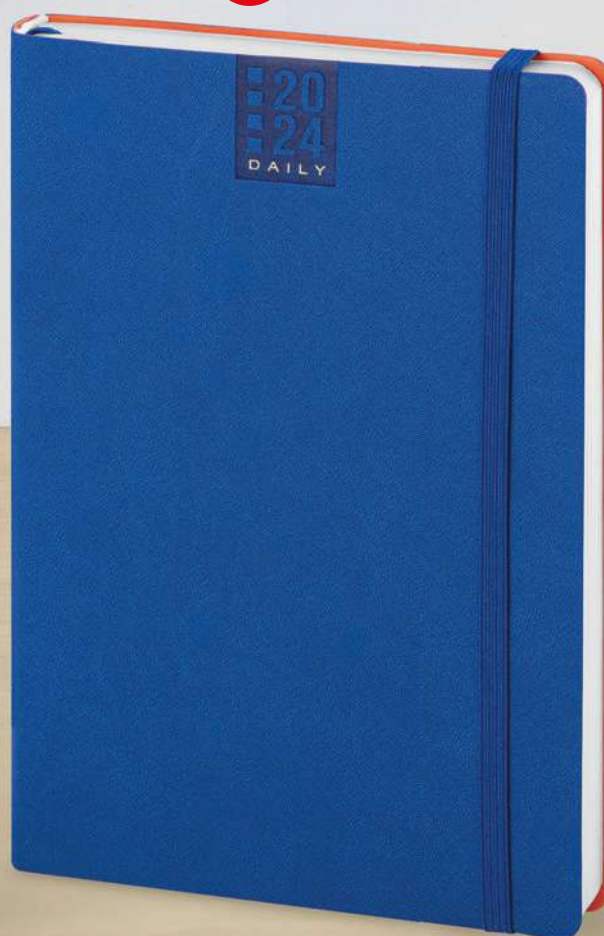

RY

### Agende Flessibili

agenda flessibile 224 pagine  
carta bianca, edizione multilingue  
planning mensile, rubrica telefonica  
pagine appunti quadretti, puntini e bianche  
materiale: poliuretano termovirante



**PB355** Agenda Settimanale  
turnario del lavoratore e inserti informativi  
☑ f.to agenda: 14x20,5 cm ca 📦 20

**AS010** Astuccio su richiesta

Termovirante



Logo Calamus  
sul retro



**PB356** Agenda Bi-Giornaliera  
☑ f.to agenda: 14x21 cm ca 📦 20

**AS010** Astuccio su richiesta

Termovirante



PB355-PB356: planning mensile

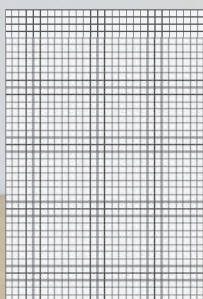

pagine note a quadretti

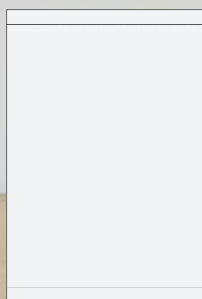

pagine note con puntini



Agende flessibili

CALAMUS®



### PB355 interno settimanale



### PB356 interno bi-giornaliero

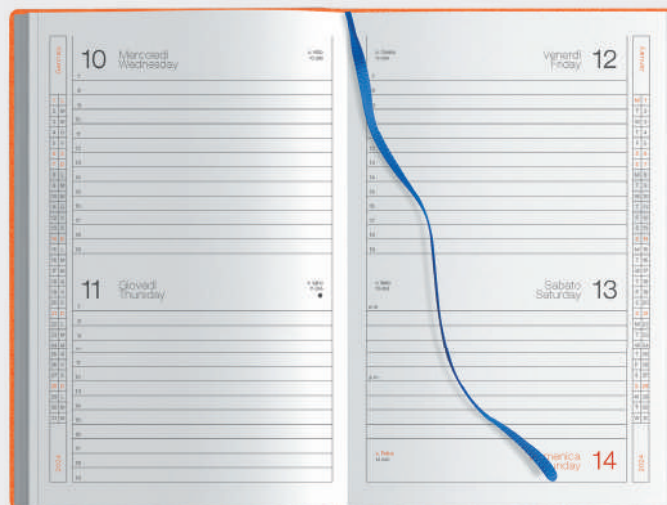

NEW!

PB296 f.to 15x21

NEW!

PB298 f.to 17x24

Sughero  
e carta

MA

BL

## Agende in sughero

324 pag. sab. e dom. abbinati  
edizione multilingue: IT - GB - FR - DE - ES - PT  
inserti informativi e rubrica telefonica  
inserto cartografico, segnapagina  
corredata di astuccio, materiale: sughero e carta



PB296 Agenda

 f.to agenda: 15x21 cm ca  20
colori disponibili: BL MA

PB298 Maxi Agenda

 f.to agenda: 17x24 cm ca  20
colori disponibili: BL MA

## Interno giornaliero sab. e dom. abbinati

**PB357** Agenda Eco Giornaliera

324 pag. sab. e dom. abbinati  
 edizione multilingue:  
 IT - GB - FR - DE - ES - PT  
 inserti informativi e rubrica telefonica  
 segnapagina, inserto cartografico  
 materiale: carta naturale



f.to agenda: 15x21 cm ca  
 20

**AS010** Astuccio su richiesta

f.to 15x21 **giornaliera**



VE

EC

**Interno Giornaliero**  
 f.to 15x21



Inserto **cartografico**

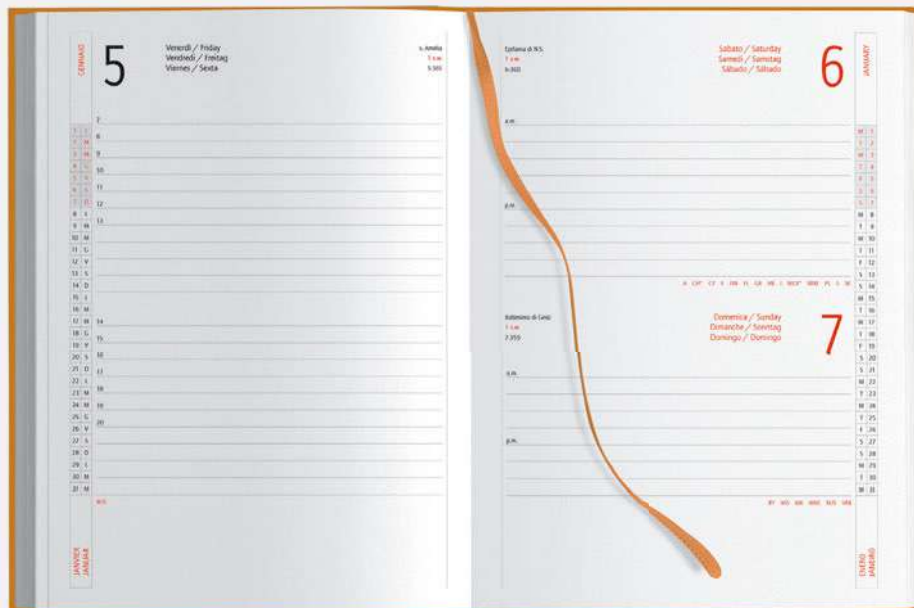

**PB358** Agenda Eco Giornaliera

324 pag. sab. e dom. abbinati  
 edizione multilingue:  
 IT - GB - FR - DE - ES - PT  
 inserti informativi e rubrica telefonica  
 segnapagina, inserto cartografico  
 chiusura con elastico  
 materiale: carta naturale



f.to agenda: 15x21 cm ca  
 20

**AS010** Astuccio su richiesta

f.to 15x21 **giornaliera**



**Carta  
 naturale**

**EC**

**VE**

## Interno Giornaliero

f.to 15x21



Inserto **cartografico**



**PB361** Agenda Eco Settimanale

132 pagine, segnapagine  
 edizione multilingue:  
 IT - GB - FR - DE - ES - PT  
 inserti informativi  
 rubrica telefonica  
 inserto cartografico  
 materiale: carta naturale



f.to agenda: 17x24 cm ca  
 30

**AS033** Astuccio su richiesta

f.to 17x24 **settimanale**



VE



**Interno Settimanale**  
 f.to 17x24



Inserto **cartografico**





**NEW!** Nuovo materiale

Quadranti Imbottiti

### Agende Italy Giornaliera

Agenda giornaliera sab. e dom. abbinati  
edizione multilingue: IT - GB - FR - DE - ES - PT  
inserti informativi e rubrica telefonica  
quadranti imbottiti, inserto cartografico  
segnapagina, materiale: gommato



f.to 17x24 cm ca

#### PB512IT Maxi Agenda

324 pag. sab. e dom. abbinati

f.to agenda: 17x24 cm ca

20

**AS020** Astuccio su richiesta

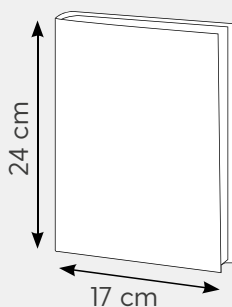

f.to 15x21 cm ca

#### PB530IT Agenda

324 pag. sab. e dom. abbinati

f.to agenda: 15x21 cm ca

20

**AS010** Astuccio su richiesta

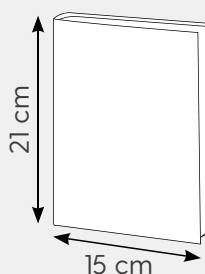

f.to 12x17 cm ca

#### PB520IT Agenda

320 pag. sab. e dom. abbinati

f.to agenda: 12x17 cm ca

20

**AS090** Astuccio su richiesta

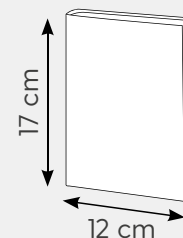



**PB540IT** Agenda Italy Settimanale

132 pagine  
 edizione multilingue:  
 IT - GB- FR- DE - ES - PT  
 inserti informativi e rubrica telefonica  
 quadranti imbottiti, inserto cartografico  
 segnapagina  
 materiale: gommato

**NEW!** Nuovo materiale

Quadranti **Imbottiti**



f.to agenda: 17x24 cm ca  
 30

**AS033** Astuccio su richiesta



**Interno Settimanale**  
 f.to 17x24



Inserto **cartografico**



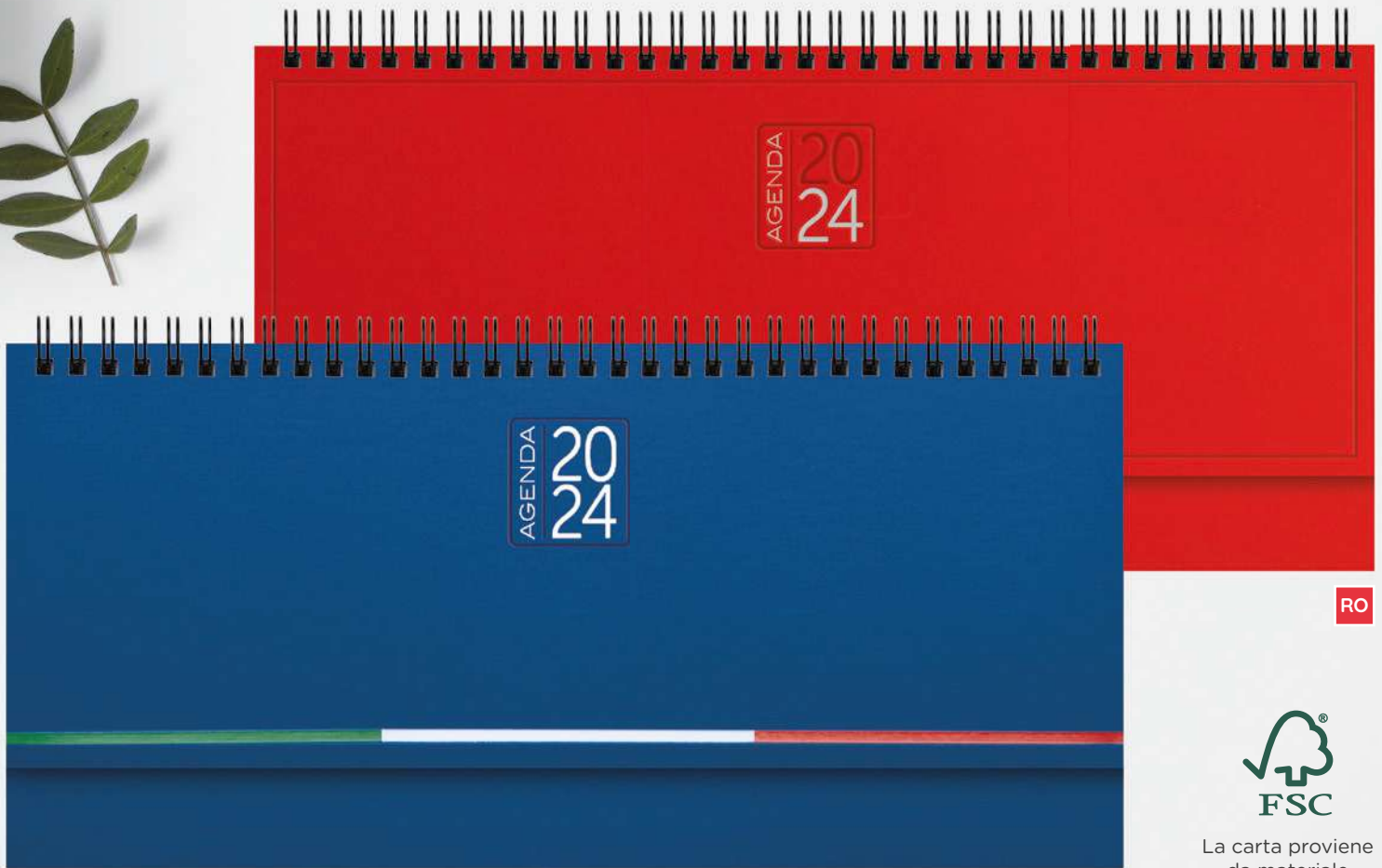

RO



La carta proviene da materiale certificato FSC®, materiale riciclato e/o legno controllato.

IT

## PB489 Planning



128 pagine, edizione multilingue: IT - GB- FR- DE - ES - PT  
inserti informativi, rubrica telefonica, materiale: gommato

f.to planning: 30x14 cm ca  20

**AS070** Astuccio su richiesta

Planning **Settimanale**

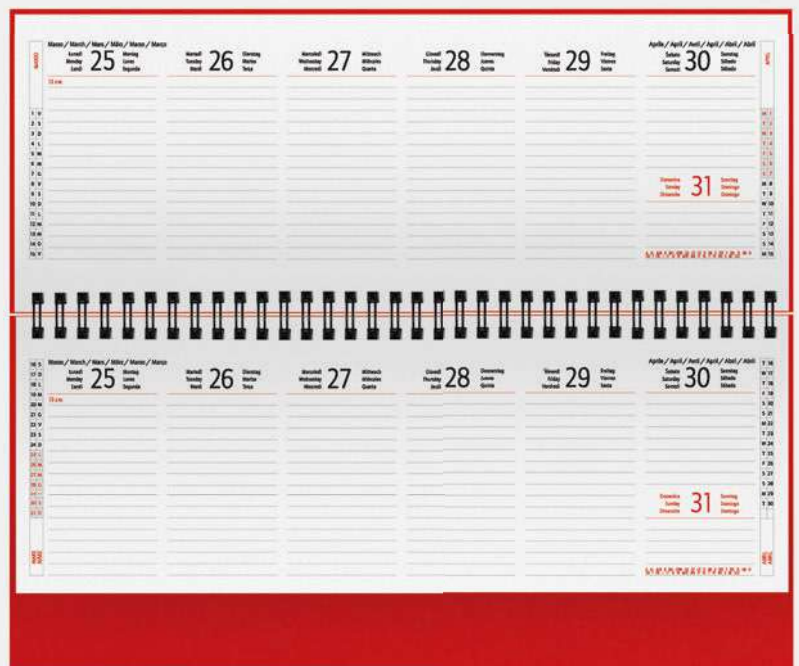

**PB499 Smart Planning**



planning 110 pagine  
carta bianca  
stampa a 2 colori  
tabella piano ferie  
calendario 2024-2025  
materiale: carta

- f.to: 25x14 cm ca
- 20



f.to 25x14 cm ca



BL



AZ

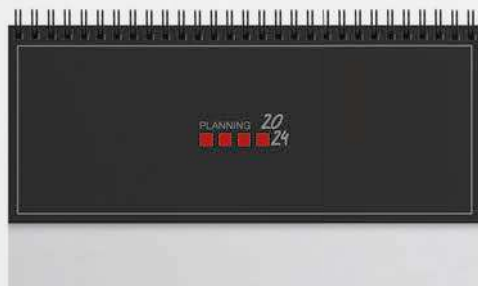

NE



RO

Interno colore azzurro/rosso varianti AZ e BL

Interno colore grigio/rosso varianti GR e RO

01 Lunedì	02 Martedì	03 Mercoledì	04 Giovedì	05 Venerdì	06 Sabato	07 Domenica
1	2	3	4	5	6	7
8	9	10	11	12	13	14
15	16	17	18	19	20	21
22	23	24	25	26	27	28
29	30	31				

GENNAIO 2024 L M M G V S S L M M G V S S L M M G V S S L M M G V S S L M M

Settimana 01

01 Lunedì	02 Martedì	03 Mercoledì	04 Giovedì	05 Venerdì	06 Sabato	07 Domenica
1	2	3	4	5	6	7
8	9	10	11	12	13	14
15	16	17	18	19	20	21
22	23	24	25	26	27	28
29	30	31				

01 Lunedì	02 Martedì	03 Mercoledì	04 Giovedì	05 Venerdì	06 Sabato	07 Domenica
1	2	3	4	5	6	7
8	9	10	11	12	13	14
15	16	17	18	19	20	21
22	23	24	25	26	27	28
29	30	31				

GENNAIO 2024 L M M G V S S L M M G V S S L M M G V S S L M M

Settimana 01

01 Lunedì	02 Martedì	03 Mercoledì	04 Giovedì	05 Venerdì	06 Sabato	07 Domenica
1	2	3	4	5	6	7
8	9	10	11	12	13	14
15	16	17	18	19	20	21
22	23	24	25	26	27	28
29	30	31				

**PB473** Libro Prenotazioni

576 pagine

ven. sab. e festivi in doppia pagina

carta bianca con stampa a 1 colore

segnapagine, inserti informativi

edizione multilingue:

IT - GB - FR - DE - ES - PT

foratura parallela al dorso

rubrica telefonica, calendario 2025

quadranti imbottiti, cucitura perimetrale

materiale: poliuretano termovirante



f.to agenda: 21x29,7 cm ca

10

**AS080** Astuccio su richiesta

NEW!

BL

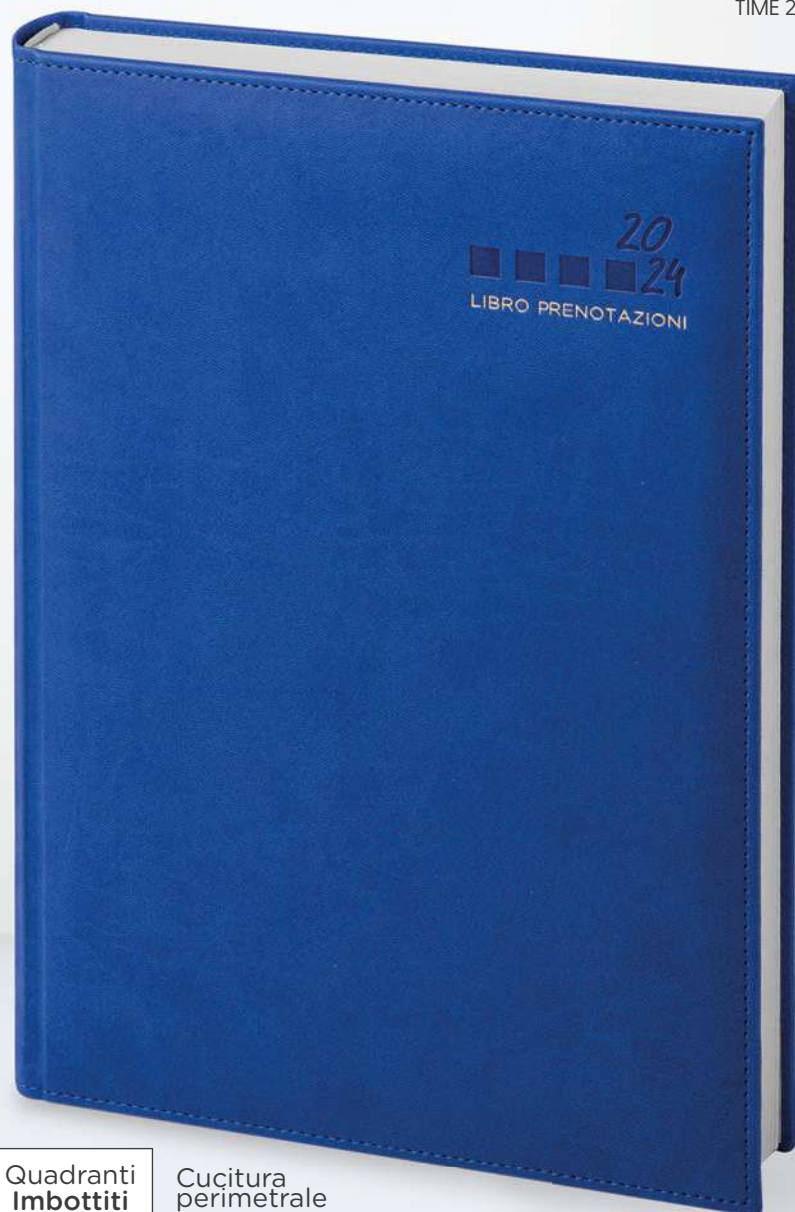

GR



TA

Quadranti  
ImbottitiCucitura  
perimetrale**Interno Giornaliero**  
**Festivi doppia pagina**

f.to 21x29,7

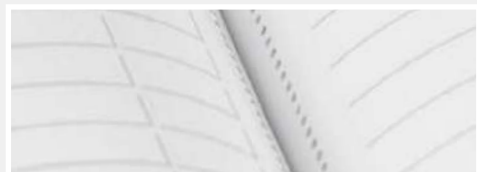
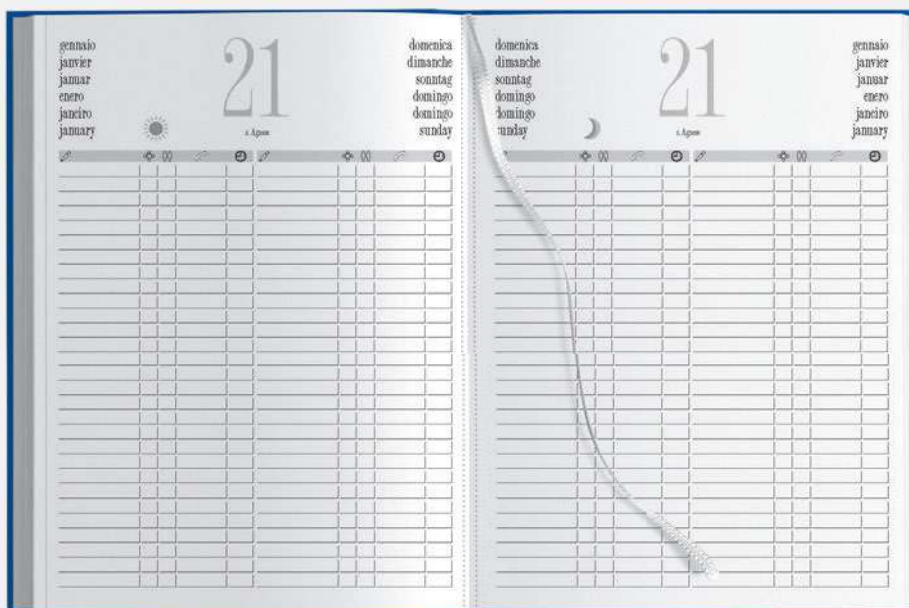
Pagine **Removibili**Foratura **Parallela al dorso**

**PB474** Libro Prenotazioni

576 pagine

ven. sab. e festivi in doppia pagina

carta bianca con stampa a 1 colore

segnapagine, inserti informativi

edizione multilingue:

IT - GB - FR - DE - ES - PT

foratura parallela al dorso

rubrica telefonica, calendario 2025

quadranti imbottiti, cucitura perimetrale

materiale: poliuretano termovirante



f.to agenda: 21x29,7 cm ca

10

**AS080** Astuccio su richiestaQuadranti **Imbottiti**

Rifinita con cucitura perimetrale

BL

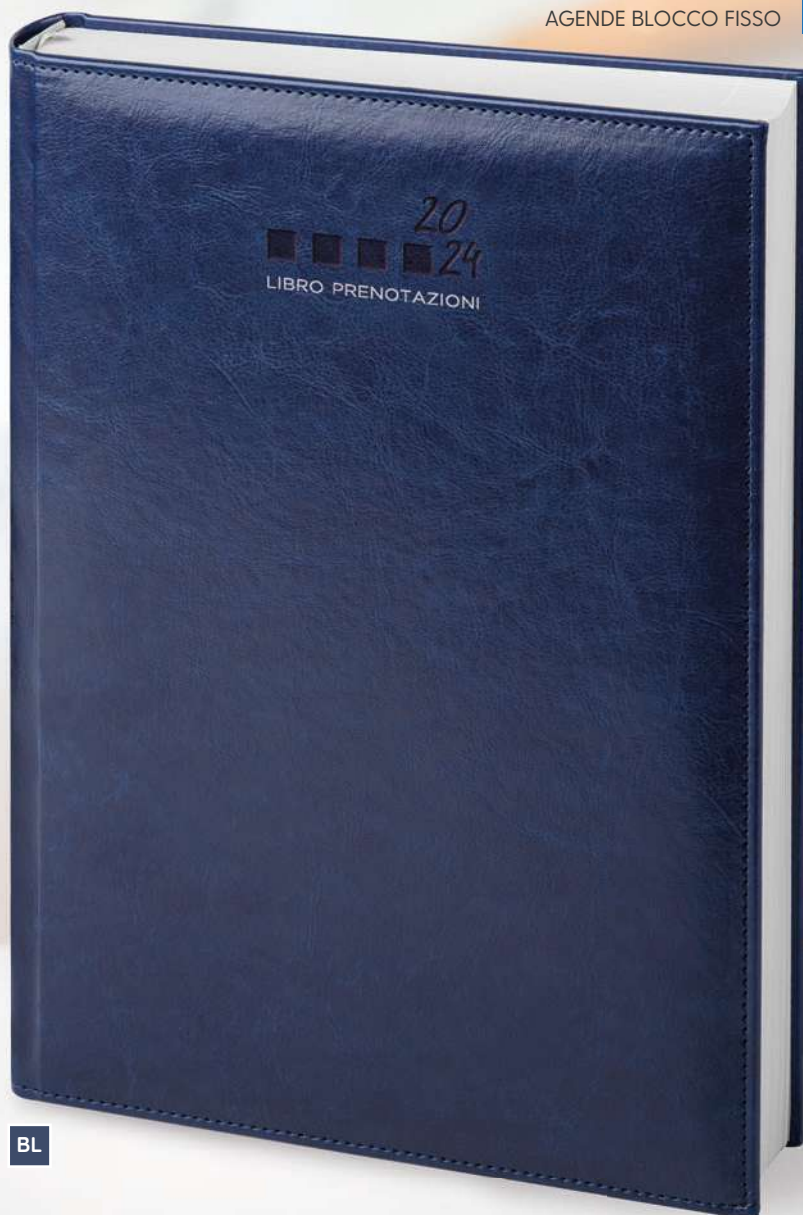
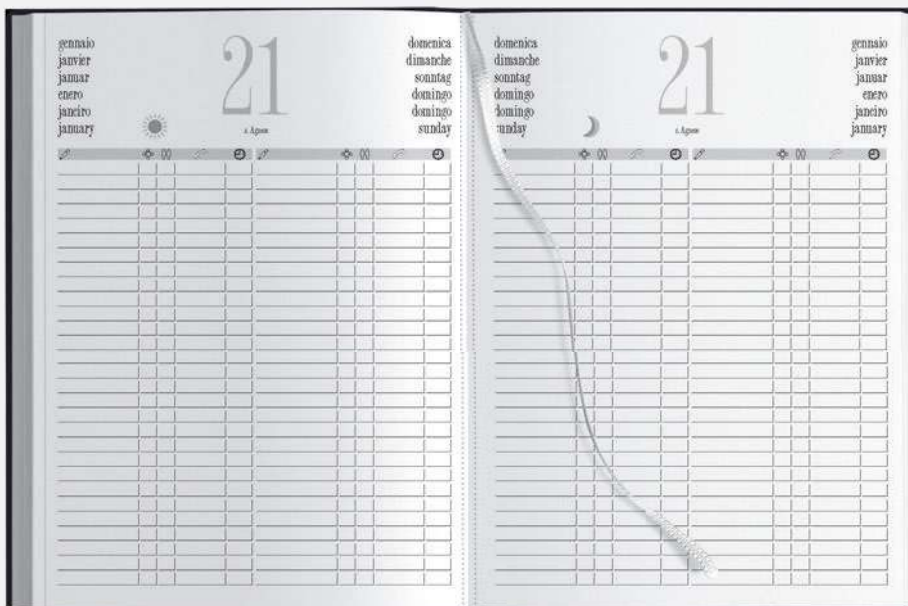
**Interno Giornaliero**  
**Festivi doppia pagina**  
f.to 21x29,7Pagine **Removibili**Foratura **Parallela al dorso**

**PB308** Maxi Agenda

400 pagine sab. e dom. separati  
 anno 2024 + gennaio 2025  
 edizione multilingue:  
 IT - GB - FR - DE  
 inserti informativi, segnapagina  
 rubrica telefonica, quadrante flessibile  
 foratura parallela al dorso  
 materiale: poliuretano termovirante



☑ f.to agenda: 21x29,7 cm ca  
 10

**AS060** Astuccio su richiesta

NEW!

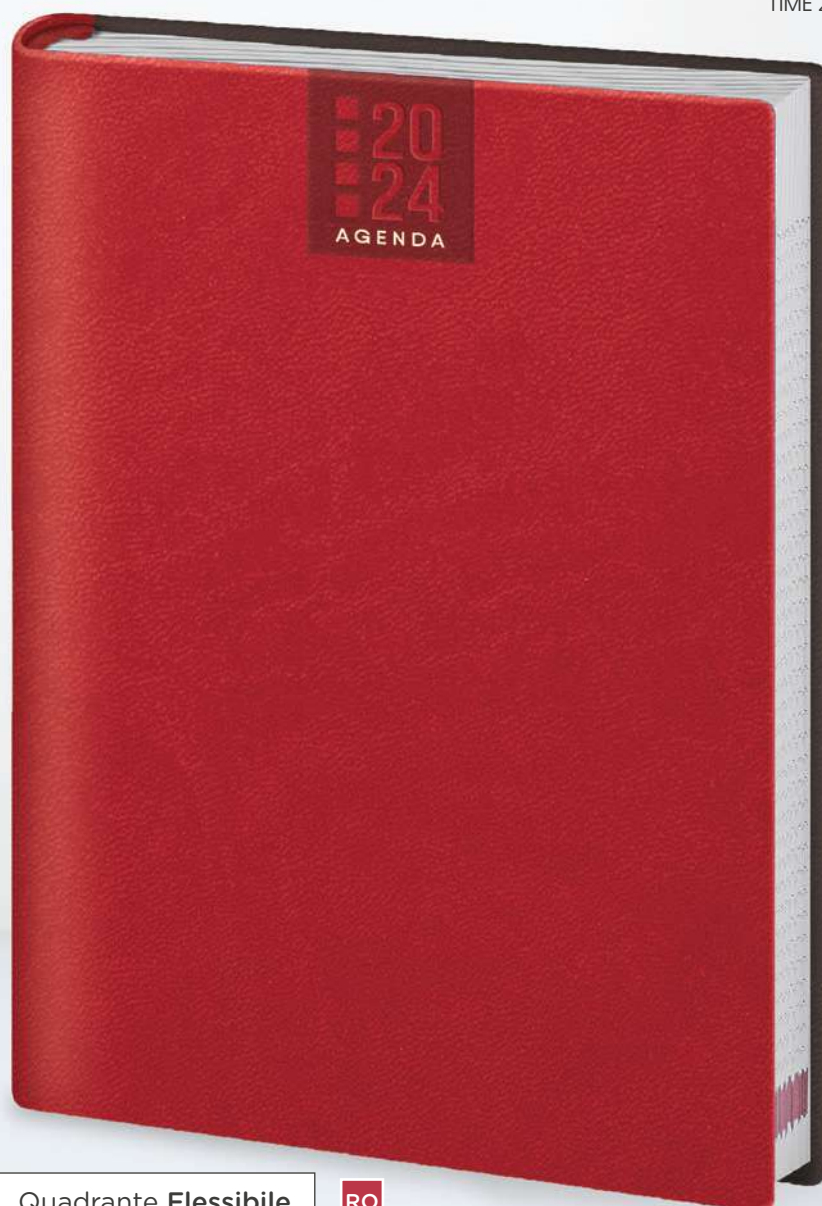

Termovirante



Quadrante Flessibile

RO

**Interno Sabato  
 e domenica separati**  
 f.to 21x29,7



Pagine Removibili



Foratura Parallela al dorso

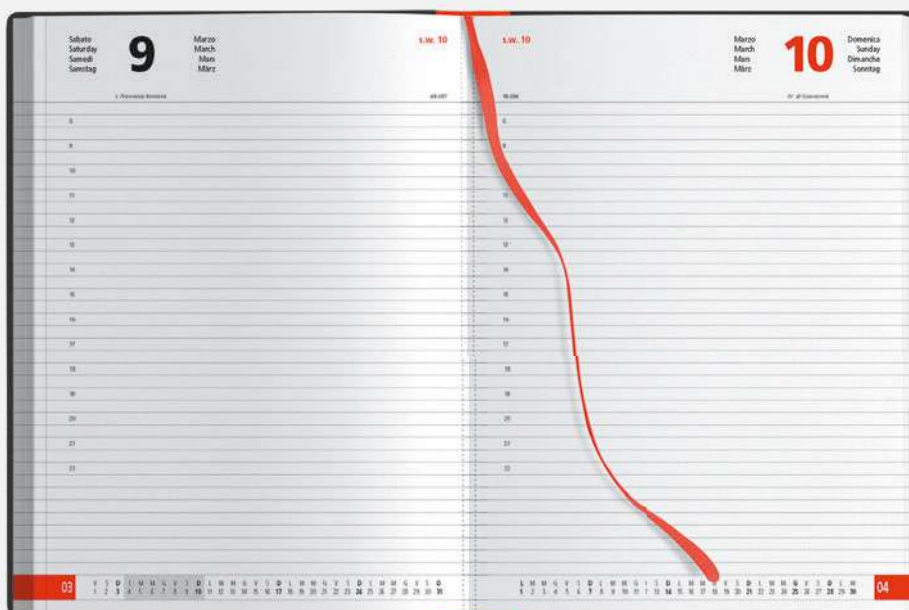

**PB505 Maxi Agenda**

400 pagine sab. e dom. separati  
 anno 2024 + gennaio 2025  
 edizione multilingue:  
 IT - GB - FR - DE  
 inserti informativi, segnapagine  
 rubrica telefonica, quadranti imbottiti  
 foratura parallela al dorso  
 materiale: poliuretano



☑ f.to agenda: 21x29,7 cm ca  
 📦 10

**AS060** Astuccio su richiesta



**BO**



Quadranti Imbottiti

**BL**

**Interno Sabato e domenica separati**  
 f.to 21x29,7



Pagine **Removibili**



Foratura **Parallela** al dorso

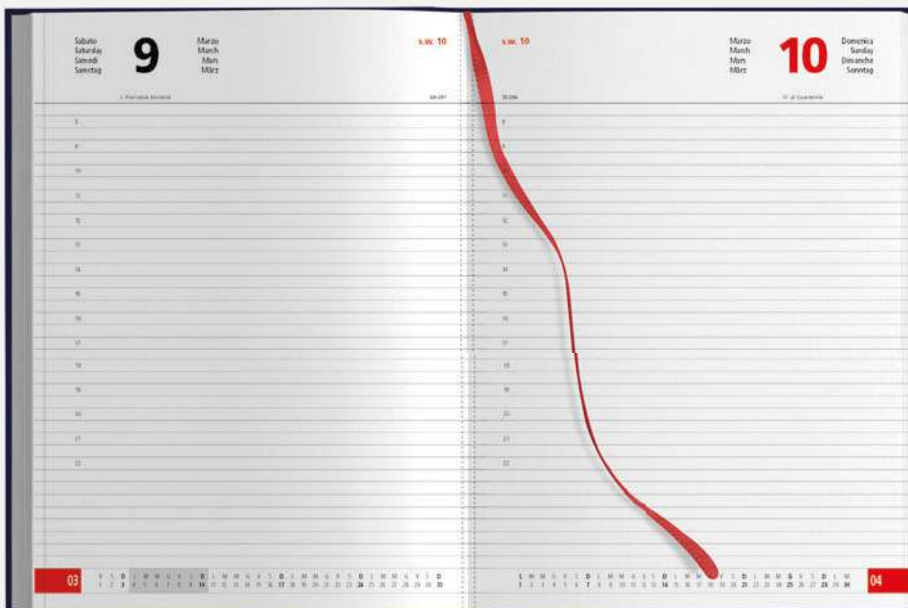

**PB506** Maxi Agenda

132 pagine  
 edizione multilingue:  
 IT - GB - FR - DE - ES - PT  
 inserti informativi, rubrica telefonica  
 quadranti imbottiti, inserto cartografico  
 segnapagina, materiale: gommato



f.to agenda: 20x27 cm ca  
 20

**AS050** Astuccio su richiesta



La carta proviene da  
 materiale certificato  
 FSC®, materiale riciclato  
 e/o legno controllato.



Quadranti Imbottiti



BL

## Interno settimanale

f.to 20x27



Inserto cartografico

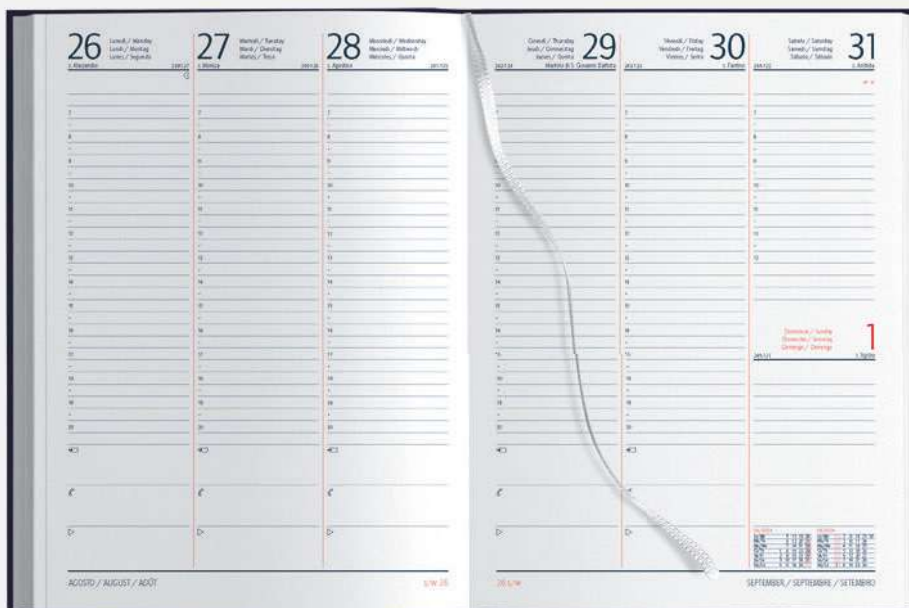



### PB510 Maxi Agenda

404 pag. sab. e dom. separati  
 edizione multilingue:  
 IT - GB - FR - DE - ES - PT  
 inserti informativi, rubrica telefonica  
 segnapagina, inserto cartografico  
 quadranti imbottiti,  
 materiale: gommato



f.to agenda: 17x24 cm ca  
 20

**AS020** Astuccio su richiesta

Quadranti Imbottiti



La carta proviene da  
 materiale certificato  
 FSC®, materiale riciclato  
 e/o legno controllato.

### Interno sabato e domenica separati f.to 17x24



Inserto cartografico



Quadranti Imbottiti



IT



La carta proviene da  
materiale certificato FSC®,  
materiale riciclato e/o  
legno controllato.

AZ

## PB512 Maxi Agenda

324 pag. sab. e dom. abbinati

edizione multilingue:

IT - GB - FR - DE - ES - PT

inserti informativi, rubrica telefonica

segnapagina, inserto cartografico

quadranti imbottiti

materiale: gommato



f.to agenda: 17x24 cm ca

20

**AS020** Astuccio su richiesta

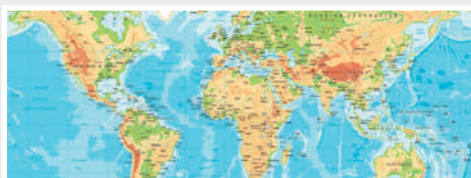

Inserto cartografico

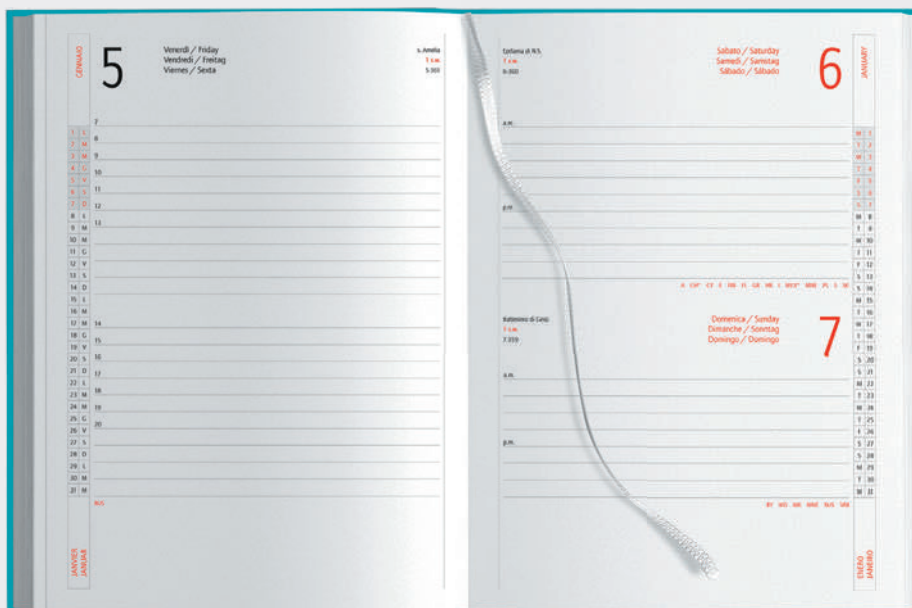

**PB520** Agenda

320 pag. sab. e dom. abbinati  
 edizione multilingue:  
 IT - GB - FR - DE - ES - PT  
 inserti informativi, rubrica telefonica  
 quadranti imbottiti, segnapagina  
 materiale: gommato



f.to agenda: 12x17 cm ca  
 20

**AS090** Astuccio su richiesta



La carta proviene da  
 materiale certificato FSC®,  
 materiale riciclato e/o  
 legno controllato.

Quadranti **Imbottiti**

**Interno sabato  
 e domenica  
 abbinati  
 f.to 12x17**



Agenda con **elastico e portapenna**



**PB528** f.to 15x21

**BL**

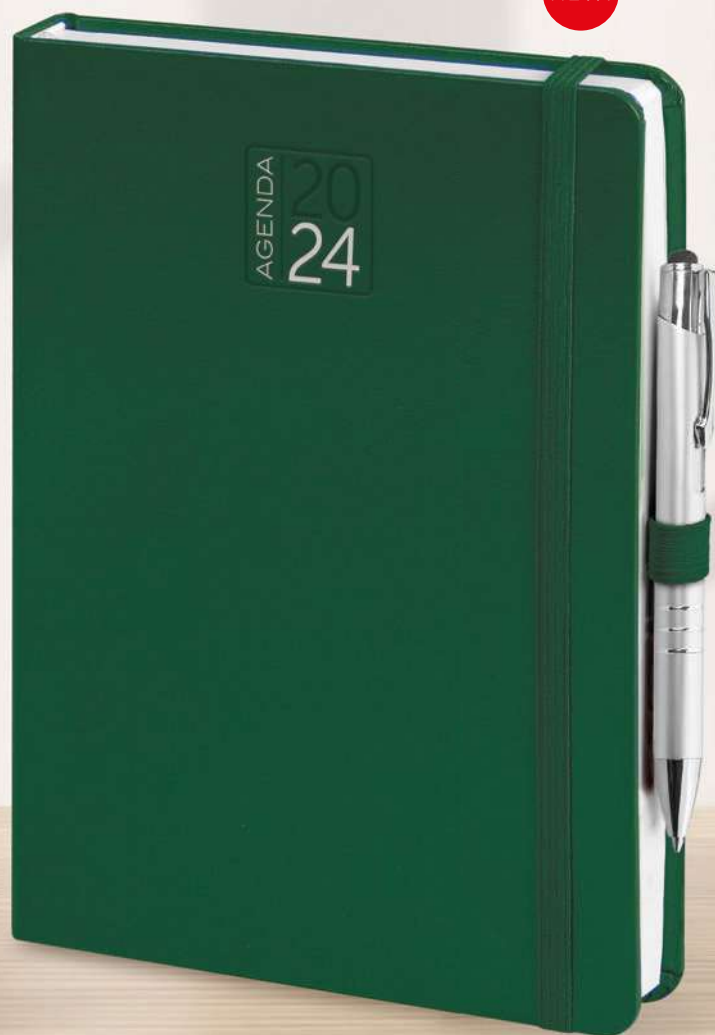

**PB524** f.to 17x24

**VE**

### Agende porta penna

carta bianca con stampa a 2 colori  
edizione multilingue: IT - GB - FR - DE - ES - PT  
inserti informativi e rubrica telefonica  
segnapagine, chiusura con elastico  
porta penna, corredato di astuccio  
materiale: midi cartonato



#### **PB528** Agenda

320 pag. sab. e dom. abbinati

f.to agenda: 15x21 cm ca  20

### Inserto cartografico



#### **PB524** Maxi agenda

320 pag. sab. e dom. abbinati

f.to agenda: 17x24 cm ca  20

**NEW!**



BO



GR



NE



RO



RY

**PB528** f.to 15x21  
sab. e dom. abbinati

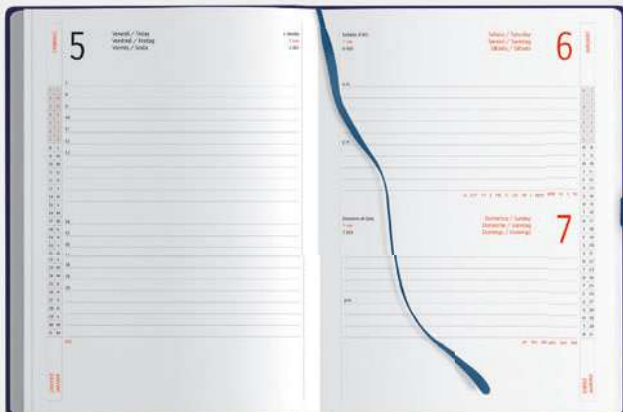

**PB524** f.to 17x24 sab. e dom. abbinati

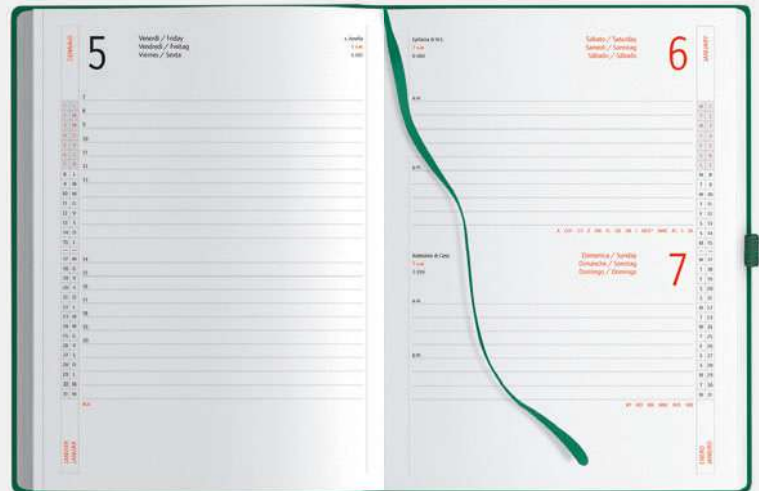

**PB526** Maxi agenda

128 pag. settimanali, edizione multilingue: IT - GB - FR - DE - ES - PT  
chiusura con elastico, segnapagina, inserti informativi e rubrica telefonica  
portapenne, corredato di astuccio, materiale: midi cartonato

☑ f.to agenda: 17x24 cm ca 📦 30



BL

BO

RO

NE

GR

VE

Agenda con elastico e portapenna

RY

## Interno settimanale

f.to 17x24



Inserto cartografico



**PB527 Agenda**



320 pag. sab. e dom. abbinati  
 edizione multilingue: IT - GB - FR - DE - ES - PT  
 chiusura con elastico, segnapagina  
 inserti informativi, rubrica telefonica  
 portapenne, corredato di astuccio  
 materiale: midi cartonato

☑ f.to agenda: 12x17 cm ca  
 📦 20



RO

NEW!

BL



BO



GR



NE



RY



VE



**Interno sabato e domenica abbinati**  
 f.to 12x17



Inserto cartografico

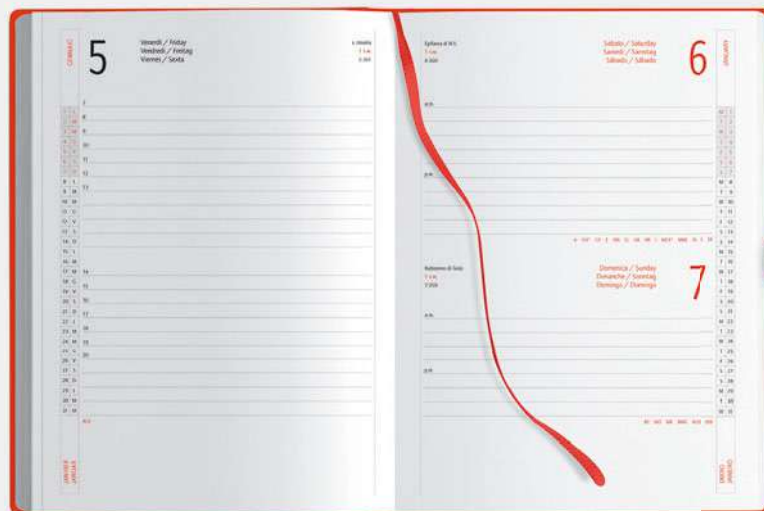

Quadranti Imbottiti



IT



La carta proviene da  
materiale certificato FSC®,  
materiale riciclato e/o  
legno controllato.

RO

### PB530 Agenda

324 pag. sab. e dom. abbinati  
edizione multilingue:  
IT - GB - FR - DE - ES - PT  
inserti informativi e rubrica telefonica  
segnapagine, inserto cartografico  
quadranti imbottiti, materiale: gommato



f.to agenda: 15x21 cm ca  
20

AS010 Astuccio su richiesta



Inserto cartografico

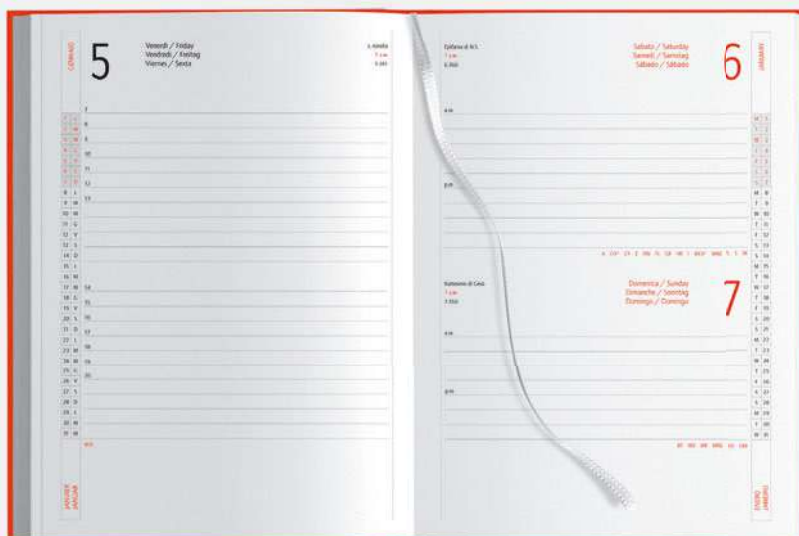





BL

Quadranti Imbottiti

**Interno sabato  
e domenica separati**  
f.to 15x21

### PB532 Agenda

404 pag. sab. e dom. separati  
edizione multilingue: IT - GB- FR- DE - ES - PT  
inserti informativi e rubrica telefonica  
segnapagina, inserto cartografico  
quadranti imbottiti  
materiale: gommato



f.to agenda: 15x21 cm ca  
 20

**AS010** Astuccio su richiesta



La carta proviene da  
materiale certificato  
FSC®, materiale riciclato  
e/o legno controllato.



Inserto cartografico

**PB535** Agenda

324 pag. sab. e dom. abbinati  
 edizione multilingue: IT - GB - FR- DE  
 inserti informativi e rubrica telefonica  
 segnapagina, inserto cartografico  
 quadranti imbottiti  
 materiale: gommato



f.to agenda: 15x21 cm ca  
 20



La carta proviene da  
 materiale certificato FSC®,  
 materiale riciclato e/o legno  
 controllato.

BO

**AS010** Astuccio su richiesta

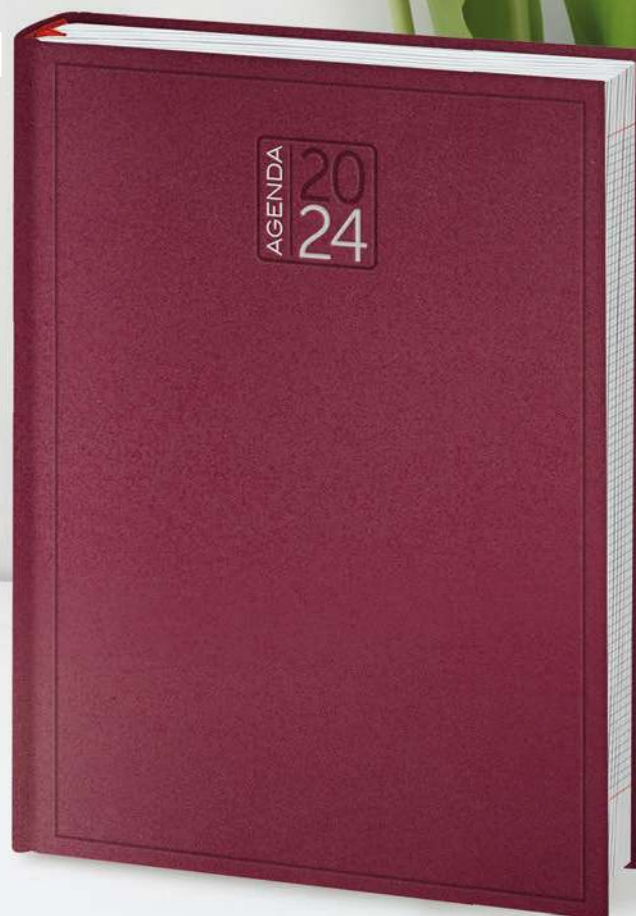

Quadranti Imbottiti

**Interno sabato  
 e domenica abbinati**  
 f.to 15x21



Inserto cartografico

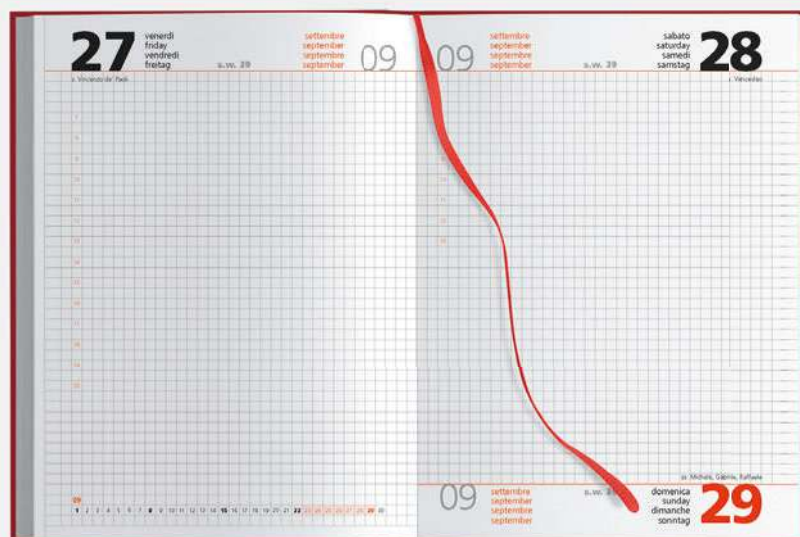

Quadranti Imbottiti



- AR
- VL
- AZ
- RO
- BL
- BI
- VE
- BO
- NE
- GR

IT



La carta proviene da materiale certificato FSC®, materiale riciclato e/o legno controllato.

AZ

**PB540** Maxi Agenda

132 pagine  
 edizione multilingue:  
 IT - GB - FR- DE - ES - PT  
 inserti informativi, rubrica telefonica  
 segnapagina, inserto cartografico  
 quadranti imbottiti, materiale: gommato



f.to agenda: 17x24 cm ca  
 30

**AS033** Astuccio su richiesta



Inserto cartografico



### PB552 Agenda Tascabile

132 pagine, edizione multilingue: IT - GB- FR- DE - ES - PT  
 inserto cartografico, inserti informativi e rubrica telefonica  
 elastico in tinta, materiale: gommato



f.to agenda: 8x15 cm ca  
 100

**AS040** Astuccio su richiesta

**NEW!**



### Interno settimanale f.to 8x15



Inserto **cartografico**

Turnario del lavoratore 2024											
GENNAIO JANUARY	PRESENZE										
	DOMENICA	TURNO	LAVORO MATERIA	INFERMIA	FERIE	PERMESSA MATERIA	PERMESSA MATERIA	PERMESSA MATERIA	PERMESSA MATERIA	PERMESSA MATERIA	PERMESSA MATERIA
1	Lunedì										
2	Marcoledì										
3	Mercoledì										
4	Giovedì										
5	Venerdì										
6	Sabato										
7	Domenica										
8	Lunedì										
9	Marcoledì										
10	Mercoledì										
11	Giovedì										
12	Venerdì										
13	Sabato										
14	Domenica										
15	Lunedì										
16	Marcoledì										
17	Mercoledì										
18	Giovedì										
19	Venerdì										
20	Sabato										
21	Domenica										
22	Lunedì										
23	Marcoledì										
24	Mercoledì										
25	Giovedì										
26	Venerdì										
27	Sabato										
28	Domenica										
29	Lunedì										
30	Marcoledì										
31	Mercoledì										

Turnario del lavoratore 2024											
FEBBRAIO FEBRUARY	PRESENZE										
	DOMENICA	TURNO	LAVORO MATERIA	INFERMIA	FERIE	PERMESSA MATERIA	PERMESSA MATERIA	PERMESSA MATERIA	PERMESSA MATERIA	PERMESSA MATERIA	PERMESSA MATERIA
1	Sabato										
2	Lunedì										
3	Sabato										
4	Domenica										
5	Lunedì										
6	Marcoledì										
7	Mercoledì										
8	Giovedì										
9	Venerdì										
10	Sabato										
11	Domenica										
12	Lunedì										
13	Marcoledì										
14	Mercoledì										
15	Giovedì										
16	Venerdì										
17	Sabato										
18	Domenica										
19	Lunedì										
20	Marcoledì										
21	Mercoledì										
22	Giovedì										
23	Venerdì										
24	Sabato										
25	Domenica										
26	Lunedì										
27	Marcoledì										
28	Mercoledì										
29	Giovedì										

Turnario del lavoratore **2024**

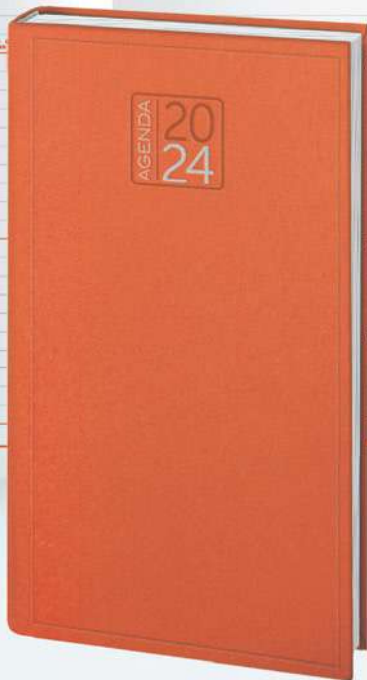

AR

Interno settimanale

Quadranti imbottiti

**PB550** Agenda Tascabile

132 pagine, inserto cartografico  
edizione multilingue: IT - GB - FR- DE - ES - PT  
inserti informativi e rubrica telefonica  
materiale: gommato



f.to agenda: 8x15 cm ca  
100

**AS040** Astuccio su richiesta



Inserto cartografico



**PB590** Blitz

calendario 2024-2025 tascabile  
rubrica telefonica, materiale: pvc



f.to: 7,5x14 cm ca  
50/500



RY



**PB544** Agenda Giornaliera

352 pagine:

333 pag. agenda sab. e dom. abbinati

12 pag. turnario del lavoratore

3 pag. per note

4 pag. con perforatura removibile verticale

carta avorio, stampa 1 colore

inserti informativi, edizione multilingue

quadranti con angoli tondi

segnapagine, chiusura con elastico

tasca posteriore interna per foglietti e card

materiale: midi cartonato



f.to agenda: 9x15 cm ca

20

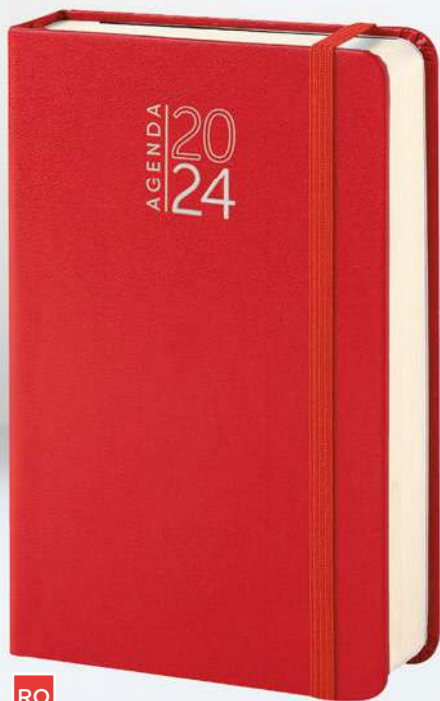
**AS045** Astuccio su richiesta

RO

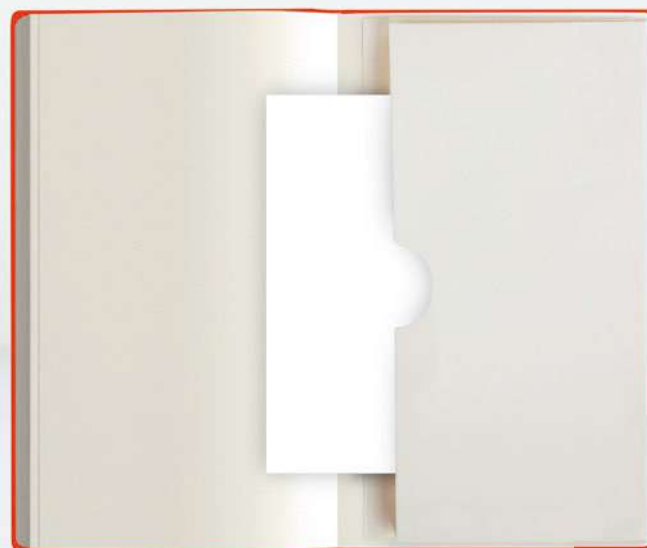
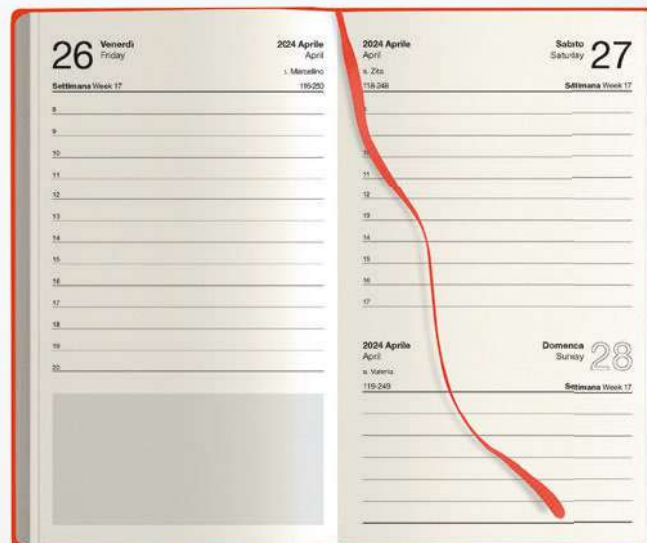

Tasca interna posteriore

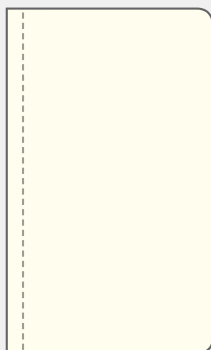
**Interno sabato  
e domenica abbinati f.to 9x15**

4 pag. perforate

180

Turnario del lavoratore 2024												Turnario del lavoratore 2024																		
GENOVA						PRATO						TERRACINA						TERRACINA												
Settimana	1	2	3	4	5	Settimana	1	2	3	4	5	Settimana	1	2	3	4	5	Settimana	1	2	3	4	5							
1	1	2	3	4	5	1	2	3	4	5	1	2	3	4	5	1	2	3	4	5	1	2	3	4	5	1	2	3	4	5

12 pag. Turnario del lavoratore



AZ

BI

BO

BL

NE

### PB546 Agenda Settimanale

- 192 pagine:
- 128 pag. agenda settimanale
- 12 pag. turnario del lavoratore
- 20 pag. per note
- 16 pag. con perforatura removibile verticale
- 16 pag. talloncini removibili con doppia perforatura
- carta avorio, stampa a 1 colore, edizione multilingue
- inserti informativi, tasca posteriore interna p/card
- quadranti con angoli tondi
- segnapagine, chiusura con elastico
- materiale: midi cartonato



f.to agenda: 9x14 cm ca  
20

**AS046** Astuccio su richiesta

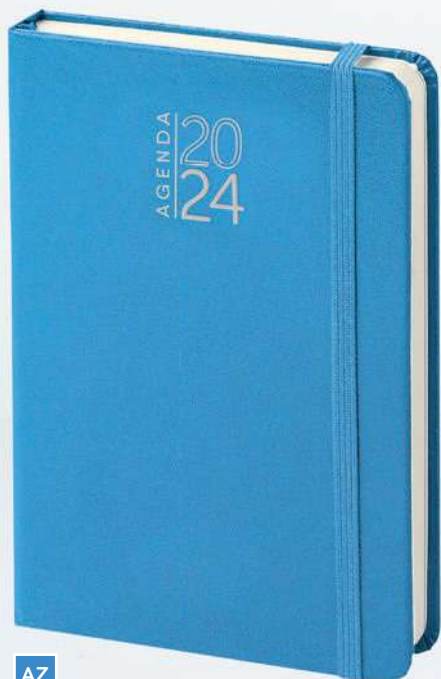
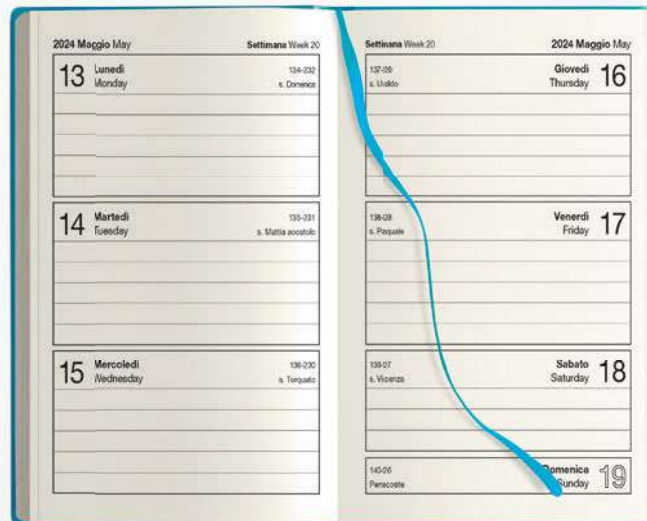

AZ

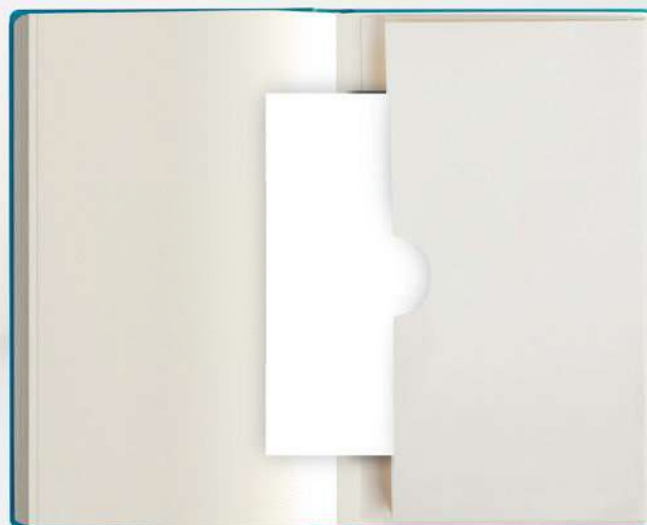

Tasca interna posteriore

### Interno settimanale

f.to 9x14

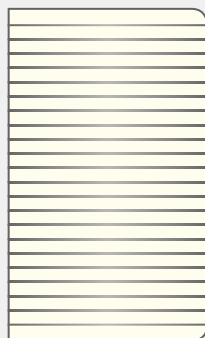

20 pag. note



16 pag. con talloncini removibili

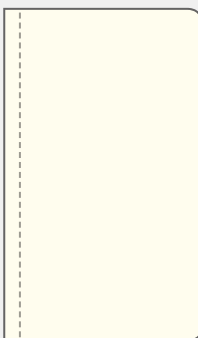

16 pag. perforate

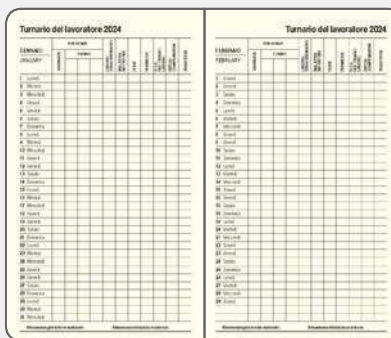

12 pag. Turnario del lavoratore

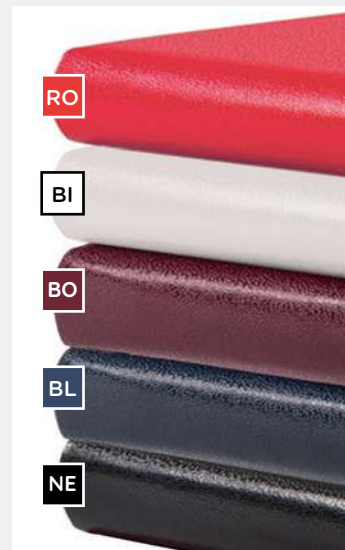

**PB572** Parure agenda e penna

352 pagine: 333 pag. agenda sab. e dom. abbinati  
4 pag. removibili perforate, 12 pag. turnario, 3 pag. per le note  
quadranti con angoli tondi, tasca posteriore interna  
chiusura con elastico, corredata di penna, materiale: midi cartonato

☑ f.to agenda: 9x15 cm ca ☑ f.to astuccio: 17,5x17,5 cm ca 📦 20/80



BL



BO



NE

## Interno sabato e domenica abbinati f.to 9x15

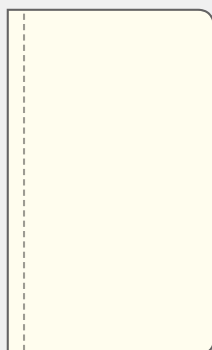

4 pag. perforate

Turnario del lavoratore 2024											
GIUGNO						LUGLIO					
GIORNO	ORA	1	2	3	4	GIORNO	ORA	1	2	3	4
1	08:00					1	08:00				
2	08:00					2	08:00				
3	08:00					3	08:00				
4	08:00					4	08:00				
5	08:00					5	08:00				
6	08:00					6	08:00				
7	08:00					7	08:00				
8	08:00					8	08:00				
9	08:00					9	08:00				
10	08:00					10	08:00				
11	08:00					11	08:00				
12	08:00					12	08:00				
13	08:00					13	08:00				
14	08:00					14	08:00				
15	08:00					15	08:00				
16	08:00					16	08:00				
17	08:00					17	08:00				
18	08:00					18	08:00				
19	08:00					19	08:00				
20	08:00					20	08:00				
21	08:00					21	08:00				
22	08:00					22	08:00				
23	08:00					23	08:00				
24	08:00					24	08:00				
25	08:00					25	08:00				
26	08:00					26	08:00				
27	08:00					27	08:00				
28	08:00					28	08:00				
29	08:00					29	08:00				
30	08:00					30	08:00				
31	08:00					31	08:00				

12 pag. Turnario del lavoratore

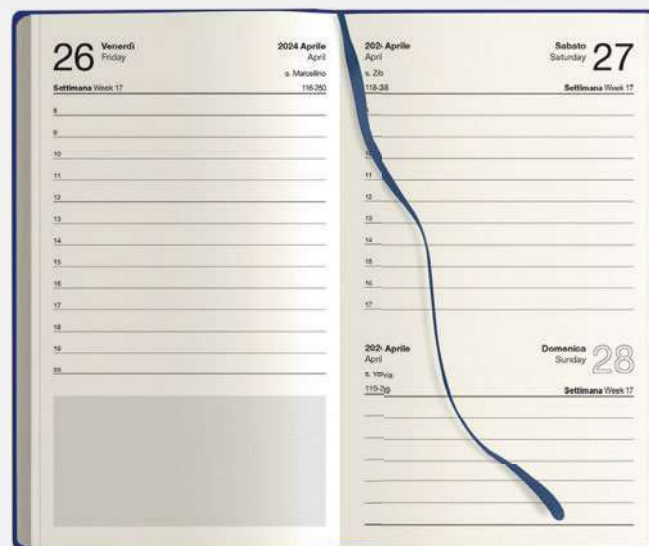

formato 9x15 cm ca



**PB573** Parure agenda e penna



192 pagine: 128 pag. agenda settimanale, 20 pag. per note  
 12 pag. turnario del lavoratore, 16 pag. con perforatura removibile verticale  
 16 pag. talloncini removibili con doppia perforatura  
 tasca posteriore interna, chiusura con elastico, corredata di penna  
 materiale: midi cartonato

☑ f.to agenda: 9x14 cm ca ☑ f.to astuccio: 17,5x17,5 cm ca 📦 20/80



BL



NE

BO

**Interno settimanale**

f.to 9x14



20 pag. note

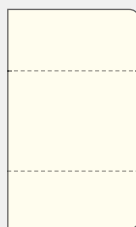

16 pag. talloncini removibili

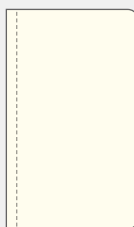

16 pag. perforate



12 pag. Turnario del lavoratore

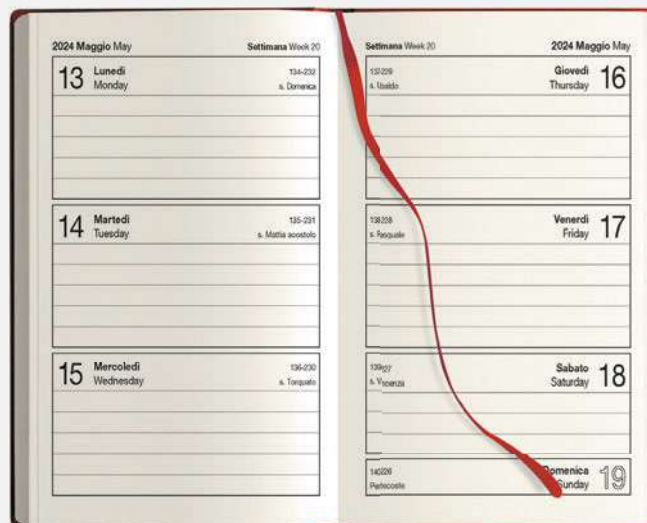

formato 9x14 cm ca

09

# Notes



**PB569** Parure canvas**NEW!**

notes con elastico  
 160 pagine avorio a righe  
 segnapagina e portapenna in tinta  
 quadranti con angoli tondi  
 chiusura con elastico  
 corredata di penna  
 materiale: cotone canvas e sughero



- ☑ f.to notes: 14x21 cm ca
- ☑ f.to astuccio: 17,3x22,3 cm ca
- 📦 30

f.to 14x21 cm ca

MA

**Interno a righe**

EC

PB575 f.to 14x21



PB576 f.to 9x14



### Notes in sughero

160 pagine a righe carta avorio  
segnapagina ed elastico in tinta  
quadranti ad angoli tondi  
chiusura con elastico, portapenne  
materiale: sughero



#### PB575 Notes

☑ f.to agenda: 14x21 cm ca 📦 20/40



#### PB576 Notes tascabile

☑ f.to agenda: 9x14 cm ca 📦 20/80

### Interno avorio pagine a righe

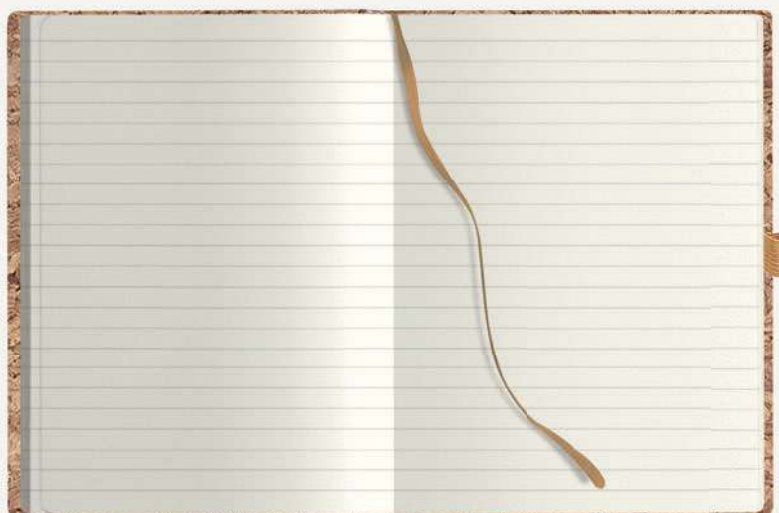

**PB577** Parure bamboo

notes con spirale in bamboo  
160 pagine a righe  
penna in bamboo  
materiale: bamboo e carta



- f.to notes: 14,5x21 cm ca
- f.to astuccio: 22,5x21,5x2 cm ca
- 1/40

f.to 14,5x21 cm ca

**Interno**  
pagine a righe

**Penna**  
in bamboo



NEW!

**PB583** Notes pendant

notes con spirale, interno 160 pagine a righe, elastico in tinta  
materiale: carta riciclata

f.to notes: 14,5x21 cm ca  20/40



Materiale  
riciclato

f.to 14,5x21 cm ca

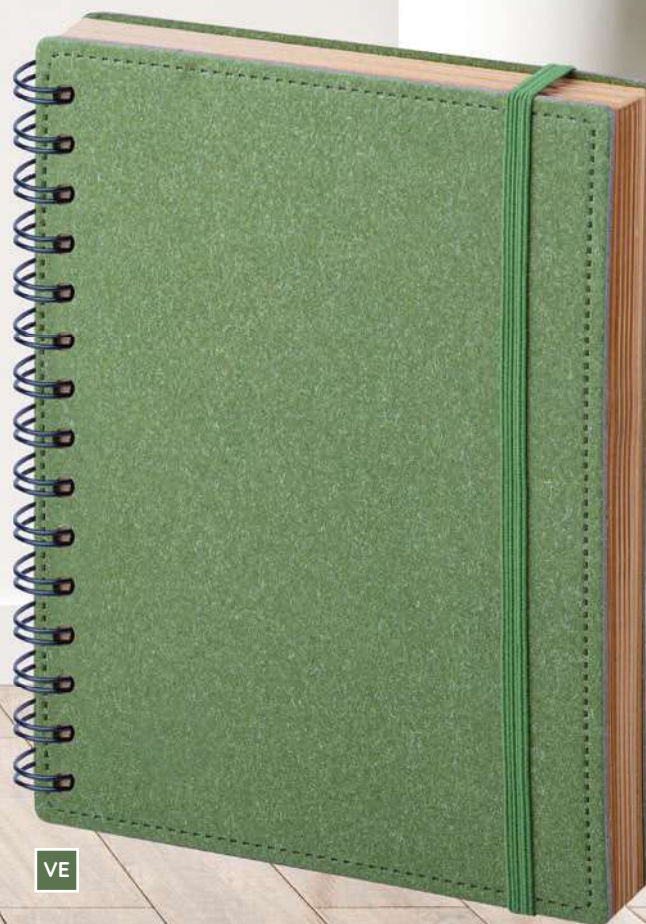
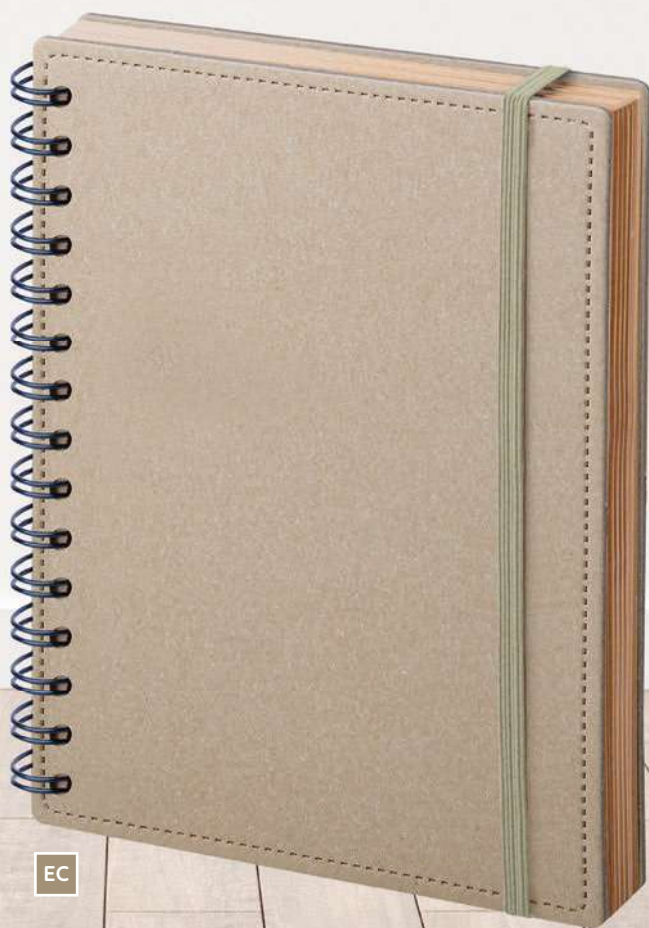

## Interno pagine a righe

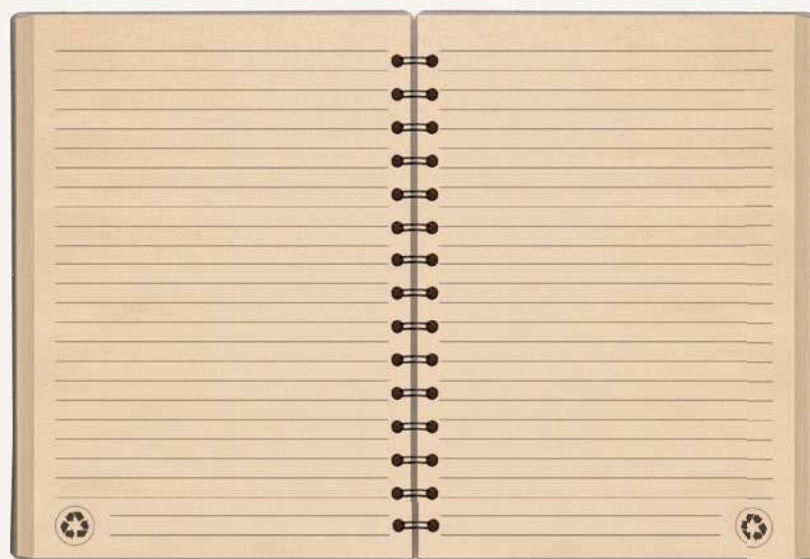

**PB587** Notes thermo paper

160 pagine a righe carta avorio, chiusura con elastico in tinta quadranti ad angoli tondi, materiale: carta termovirante

f.to notes: 14x21 cm ca  1/40

**PB598** Astuccio su richiesta



Termo  
Personalizzabile

f.to 14x21 cm ca

## Interno avorio pagine a righe

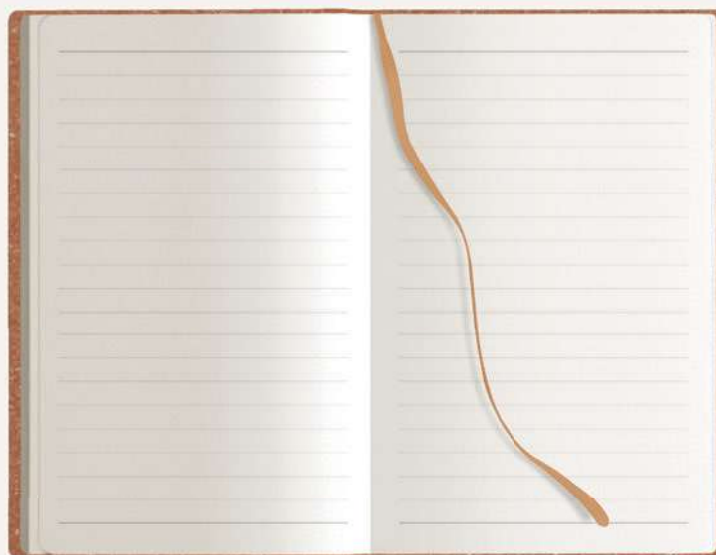

NEW!

PB588 f.to 15x21



VE



Materiale riciclato

NEW!

PB611 f.to 9x14



EC

## Notes in carta riciclata

160 pagine a righe  
elastico colorato  
materiale: carta riciclata



### PB588 Notes

☑ f.to agenda: 15x21 cm ca 📦 20/40

colori disponibili: **VE** **EC**



### PB611 Notes tascabile

☑ f.to agenda: 9x14 cm ca 📦 20/80

colori disponibili: **VE** **EC**

## Interno pagine a righe

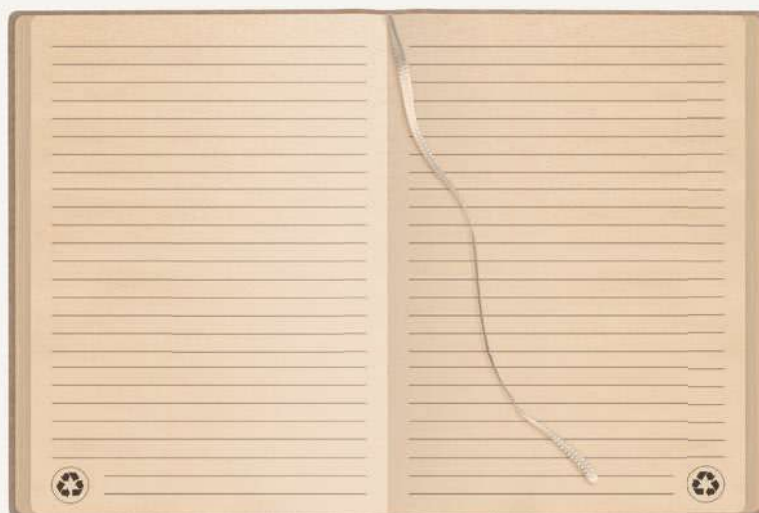



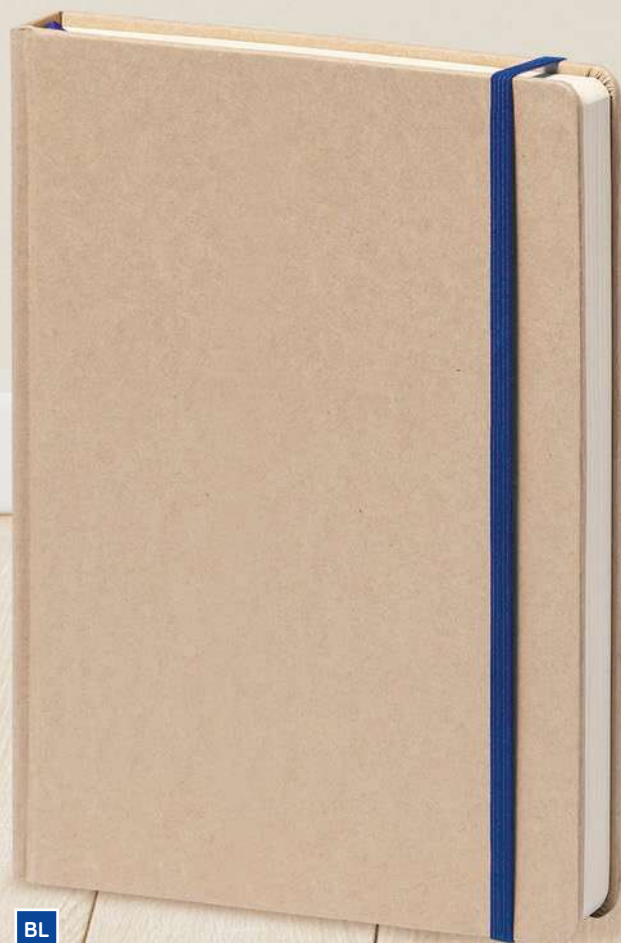

BL

PB589 f.to 14x21



PB603 f.to 9x14

BI



NE



RO



VE

## Notes in carta kraft

160 pagine a righe carta avorio  
segnapagina ed elastico colorato  
quadranti ad angoli tondi  
materiale: carta kraft



### PB589 Notes

☑ f.to agenda: 14x21 cm ca 📦 20/40

colori disponibili: BI BL NE RO VE



### PB603 Notes tascabile

☑ f.to agenda: 9x14 cm ca 📦 20/80

colori disponibili: BI BL NE RO VE

## Interno avorio pagine a righe



f.to 14x21 cm ca

NEW!

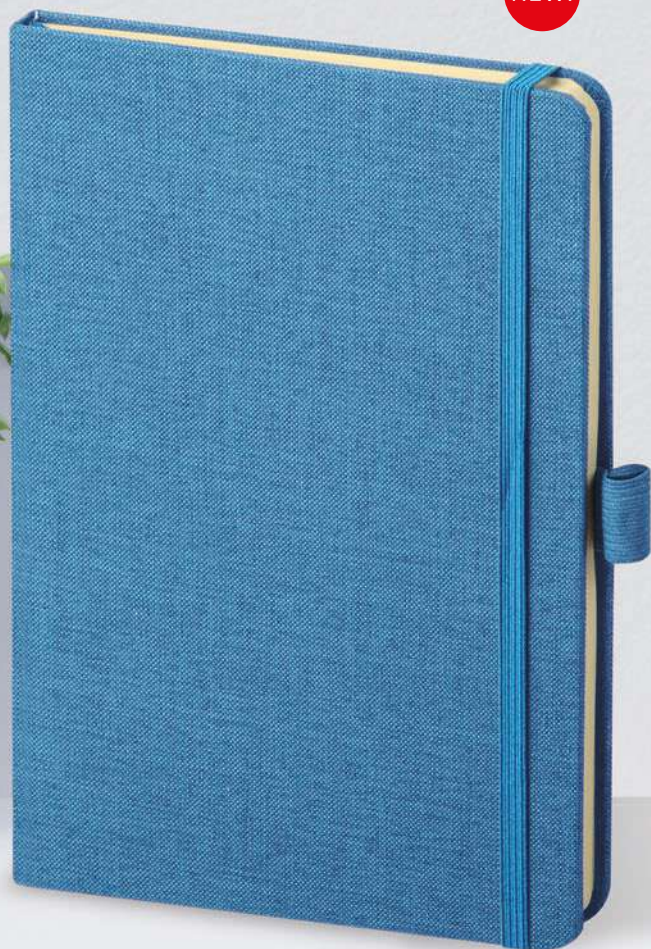

AZ



BL

EC

GR



MA

NE

RO



VE

Notes con elastico  
e portapenne  
in carta e poliestere

Interno avorio pagine a righe

### PB594 Notes wave



160 pagine a righe carta avorio  
segnapagina ed elastico in tinta  
quadranti ad angoli tondi  
portapenne, chiusura con elastico  
materiale: poliestere e carta

☑ f.to notes: 14x21 cm ca

📦 1/30

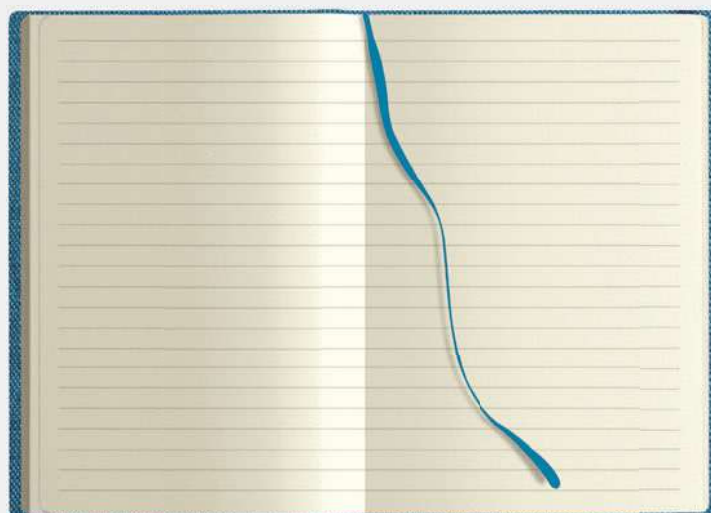

**PB582 Flex Notes**



224 pagine a righe carta bianca elastico in tinta, materiale flessibile materiale: poliuretano termovirante

- ☑ f.to notes:14x21 cm ca
- 📦 10/50

CALAMUS®

f.to 14x21 cm ca



Logo Calamus sul retro

NEW!

Termovirante



Interno pagine a righe

Notes flessibile

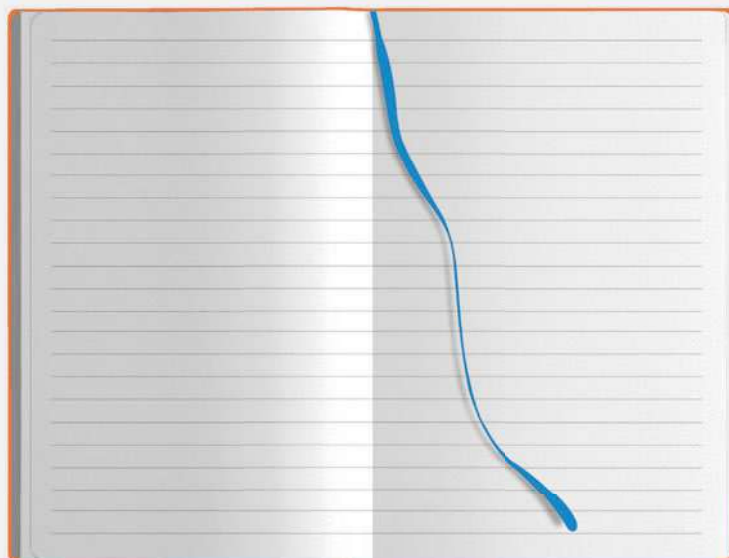

**PB581** Notes thermo

200 pagine a righe carta avorio elastico in tinta, quadranti ad angoli tondi portapenne, chiusura con elastico materiale: poliuretano termovirante

- ☑ f.to notes: 14x21 cm ca
- 📦 20/40

NEW!

Termovirante

CALAMUS®

f.to 14x21 cm ca

Logo Calamus  
sul retro

BL

AZ

VE

NE

SA

GR

RO

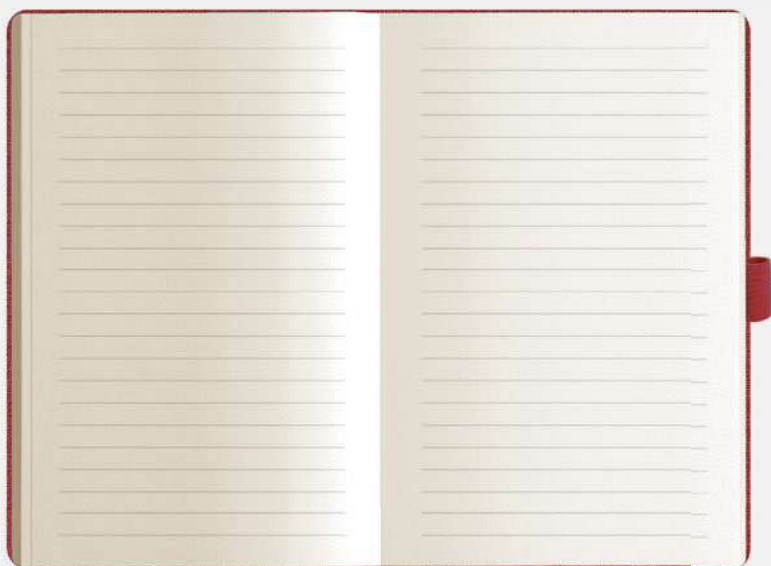
**Interno avorio** pagine a righeNotes  
flessibile

f.to 13x21 cm ca

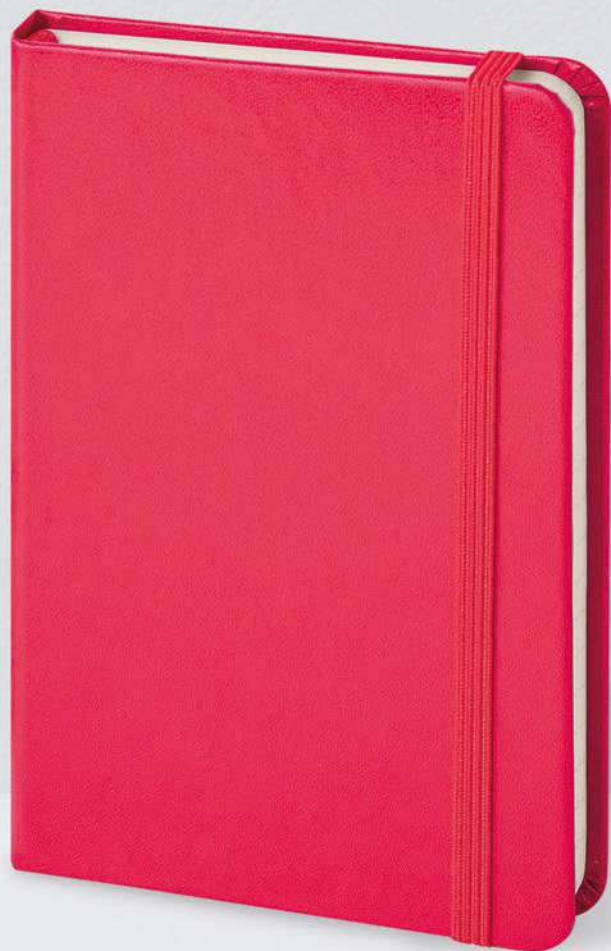

RO



AR

AZ

BI

BL

GR

NE

RY

VE

VL

### Interno avorio pagine neutre

#### PB599 Notes midi

240 pagine neutre carta avorio  
segnapagine ed elastico in tinta  
quadranti ad angoli tondi  
chiusura con elastico  
materiale: midi cartonato



f.to notes: 13x21 cm ca  
20/40

PB598 Astuccio su richiesta

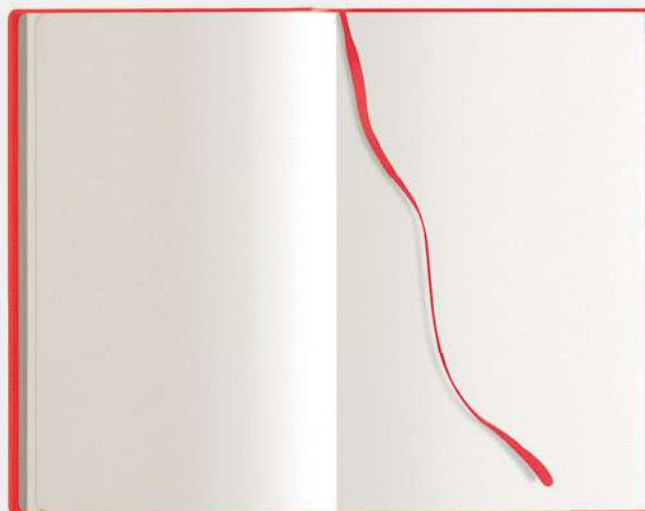

**PB600** Notes pen

240 pagine a righe carta avorio, segnapagina ed elastico in tinta quadranti ad angoli tondi, chiusura con elastico, portapenne materiale: midi cartonato

☑ f.to notes: 13x21 cm ca ☑ 20/40

f.to 13x21 cm ca

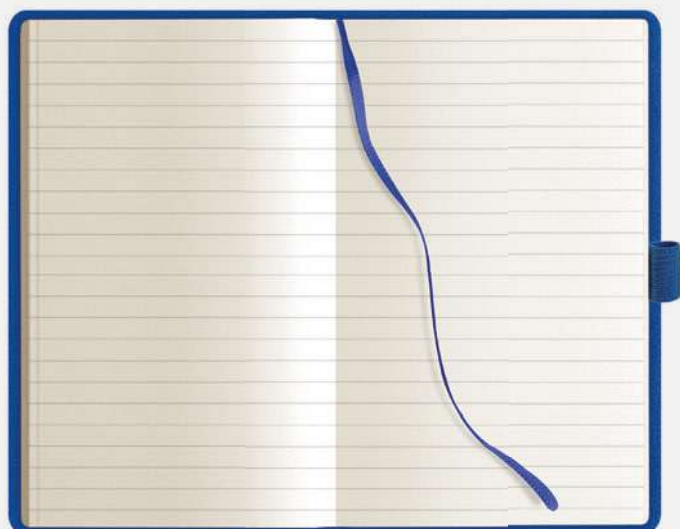
**PB596** Astuccio su richiesta**Interno avorio** pagine a righe

## Tasca interna posteriore

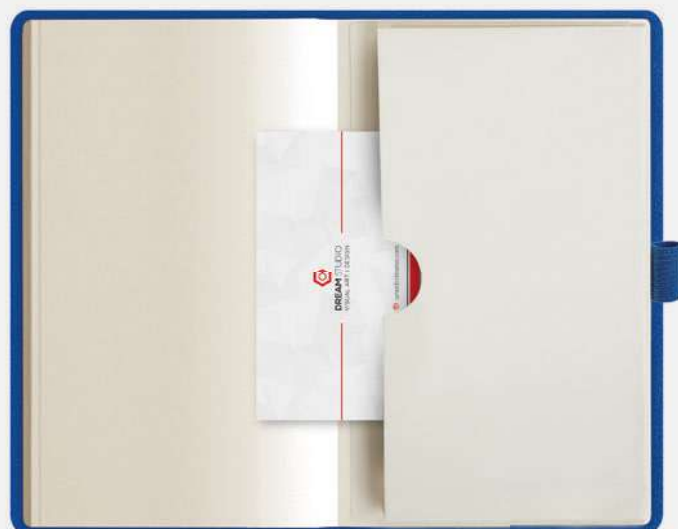

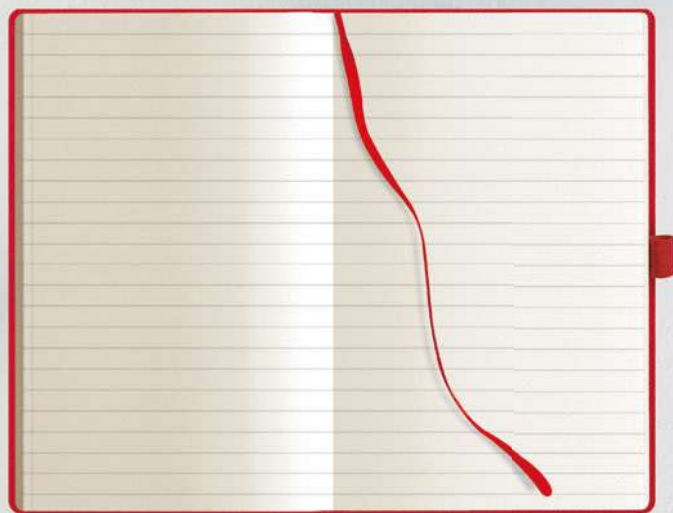

Interno avorio pagine a righe



Tasca interna posteriore

**PB607** Notes pen class

160 pagine a righe carta avorio  
segnapagina, elastico  
portapenne, quadranti angoli tondi  
materiale: midi cartonato

☑ f.to notes: 9x14 cm ca

📦 20/80

f.to 9x14 cm ca



RO



BA



BI



BL



BO



NE

**PB614** Notes color

160 pagine neutre carta bianca  
segnapagine ed elastico in tinta  
quadranti ad angoli tondi  
materiale: midi cartonato

☑ f.to notes: 9x14 cm ca ☑ 20/80

**AS046** Astuccio su richiesta

f.to 9x14 cm ca

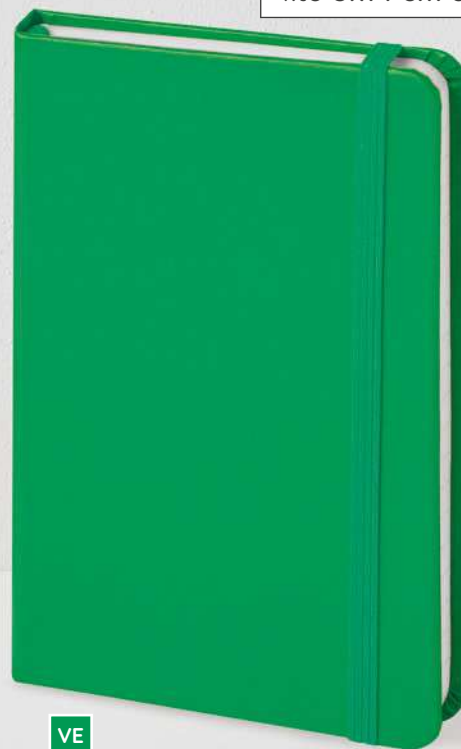

### Interno bianco pagine neutre

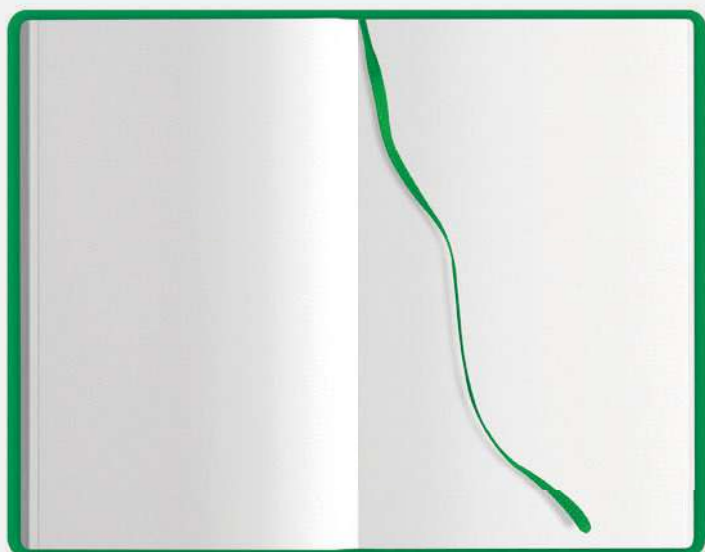



**PB616** Notes line

160 pagine a righe carta bianca  
segnapagina ed elastico in tinta  
quadranti ad angoli tondi  
materiale: midi cartonato

☑ f.to notes: 9x14 cm ca 📦 20/80

**AS046** Astuccio su richiesta



f.to 9x14 cm ca

BL



AR



AZ

NEW!



BI



GR

NEW!



NE



RO



RY



VE



VL

NEW!

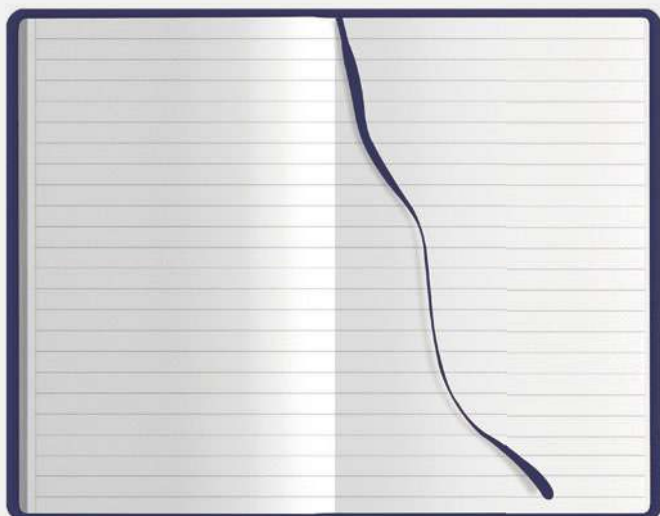
**Interno bianco** pagine a righe

NEW!

f.to 14x21 cm ca



### PB620 PU notes



160 pagine a righe  
carta bianca  
elastico in tinta  
segnapagine in tinta  
materiale: PU

- f.to agenda: 14x21 cm ca
- 20/40

**Interno** pagine a righe

---

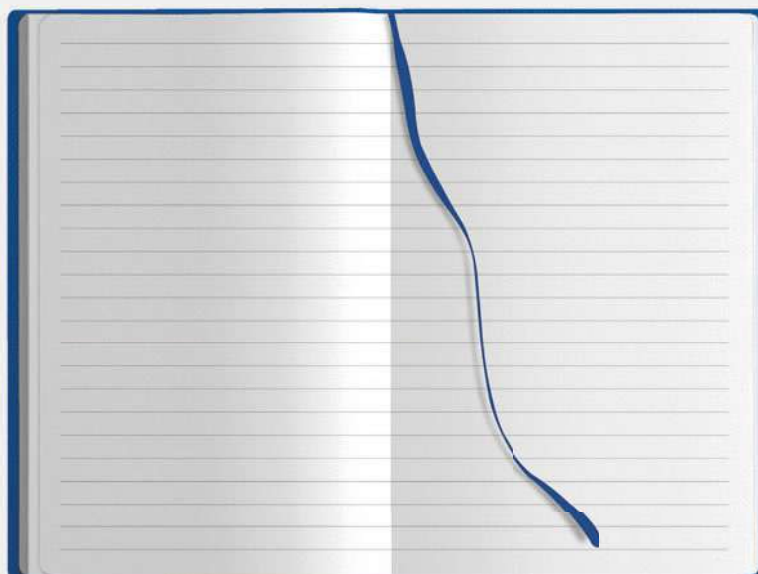

**PB621** Mini PU Notes



160 pagine a righe carta bianca elastico e segnapagina in tinta materiale: PU

☑ f.to agenda: 9x14 cm ca 📦 20/80

**AS046** Astuccio su richiesta

**NEW!**

f.to 9x14 cm ca



VL



AR



BI



BL



GI



GR



NE



RO



RY



VE

**Interno bianco** pagine a righe

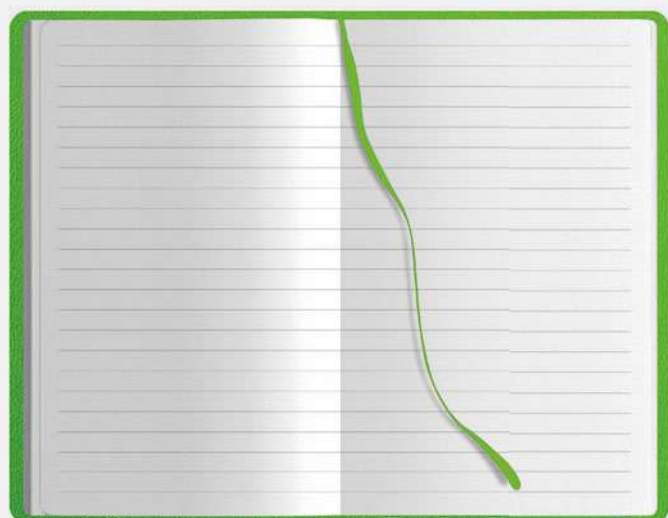

**NEW!**  
Banda  
personalizzabile  
dim. 31x5 cm ca



**ART FOCUS**  
ART SOLUTIONS

via Roma, 01  
Milano  
200019



### PB495 Planning Stickers



planning 52 fogli settimanali  
4 blocchi fogli adesivi colorati  
5 blocchi segnapagine adesivi colorati  
penna in carta inclusa  
banda per la personalizzazione 31x5 cm ca  
materiale: carta

f.to planning: 31x17,5 cm ca  
 25/50



**Carta  
Naturale**



<b>GIFT</b>	
<b>A</b>	
Accendini	329-332
Apribottiglia	161-165, 323, 324
Asciugamani	453-457
Astuccio Portapenne	5
Asuccio per Tazza	141-142
Auricolari	346-349
<b>B</b>	
Basi di ricarica	339-345
Bavaglio Ristorante	152
Beauty case	295-303
Block Notes	71
Borracce in acciaio	116-130
Borracce in alluminio	131-135
Borracce in tritan	136
Borracce/Lattine	125, 128
Borsa P/Pizza	147
Borse P/Pranzo	144, 145
Borse P/Vino	148-151
Borse Mare	232-234
Borse da Viaggio	289
Borse P/computer e P/tablet	59, 62, 252-264, 270
Borse Portadocumenti	59-65
Borse Shopping in Carta	167-176
Borse Shopping in Cotone	221-249
Borse Shopping in Cotone Canvas	229-232
Borse Shopping in Cotone Organico	227-229
Borse Shopping in Cotone Riciclato	224-226
Borse Shopping in Juta	233-235
Borse Shopping in Poliestere	177, 189-191
Borse Shopping in Polietilene	196
Borse Shopping in Polipropilene	178-179
Borse Shopping TNT	192-220
Borse Shopping TNT Glitter	198
Borse Shopping TNT Laminato	197
Borse Shopping TNT RPET	192-195
Borse Termiche	180-188
Borsellino da Collo	81
Borsoni e Zaini Sport	282-287
Box Portabottiglie	148
Buste Portadocumenti	76, 77, 363-369
Buste Portavino	174
<b>C</b>	
Calendario da Scrivania	83, 86
Calendario Mousepad	111
Caricatori da Muro	352
Carrelli Spesa	177
Cartelle Sottobraccio	66-70
Cartelline Portablocco	70
Cavatappi	161-163
Cavi di Ricarica	355-357
Coltellini Multiuso	162, 163
Cuffie	346
<b>D</b>	
Dischi Orari	370, 371
Display in plexiglass	157-159
Doppi Metri	383
<b>E</b>	
Etichette per Valigia	291
<b>F</b>	
Fermacarte/Fermasoldi	75
Flaconi Spray	308
Flessometri	364
<b>G</b>	
Gancio Appendiborse	314
Gancio per Borracce	117, 119, 126, 130, 135, 137

Gilet	376, 450, 451
Grebbiuli	153-156
<b>I</b>	
Impermeabili	400, 401
<b>K</b>	
Kit di ricarica per auto	352
Kit Fermatarga	372
<b>L</b>	
Lampada Caricabatterie	342
Lampada da Campeggio	309
Lampada USB	109, 342
Lanyard	78-81
Lente d'Ingrandimento	112
Lunch Bag	186-188
Lunch box	144, 145
<b>M</b>	
Marsupio	280
Matita in carta di giornale	54
Matita inesauroibile	50
Matite	54-57, 385
Matite Sprout	55
Metri	383, 384
Mousepad	109-111, 343
<b>N</b>	
Necessaire da Viaggio	295-303
<b>O</b>	
Ombrelli	387-400
Ombrelli Antivento	388, 394, 397
Orologi smart	
<b>P</b>	
Panno Auto	376
Pastelli	52-54
Penne in Alluminio	6, 7, 13, 19, 20
Penne in Bamboo	8, 45-50
Penne in Caffè	50
Penne in Carta	43, 44, 50
Penne in Metallo	8-18
Penne in Paglia di Frumento	42-45
Penne in Plastica	21-41
Penne in Plastica Antibatterica	21-40
Penne Spray	21-23
Penne in RPET	51
Penne in Sughero	8, 45, 50, 51
Penne Touch	15-20, 22-28, 42, 44, 47-49
Poncho Antipioggia	401
Portabadge	78
Portabiglietti da Visita	72, 74, 75
Portabottiglia	148-151, 174
Portacalice con Tracolla in Tnt	152
Portacard/Portapatente	72-75, 377-382
Portachiavi Galleggianti	326, 327
Portachiavi in Ecopelle	312
Portachiavi in Legno	319-321
Portachiavi in Metallo	311-314, 324
Portachiavi in Plastica	315, 318, 322, 323, 325
Portachiavi in Poliestere	314, 325
Portachiavi in Poliuretano	311, 315, 316
Portachiavi portamonete	315, 316
Portacontrassegni per Auto	363-369
Portadocumenti da Viaggio	292-294
Portadocumenti per Farmacia	369
Portadocumenti per Auto	363-369
Portamonete	315, 316
Portamenù	157, 158, 160
Portapassaporto	292-294
Portapenne da Scrivania	82-84

Portapillole	308
Portapranzo	144, 145
Portatarga	372-375
Posacenere Tascabile	333
Post-it e Portafoglietti	86-89, 105-108
Powerbank	352-355
P/Carte da Scrivania	86-89, 105-108

<b>R</b>	
Radiosveglia	338
Rendiresto	159
Righelli	112, 113
Rolline Metriche	384

<b>S</b>	
Sacche zaino	222-224, 276-279
Scaldatazza	341
Scatola Portabottiglie	148
Sedia Pieghevole	309
Set da Viaggio	292
Set Matite e Pastelli	52-54, 57
Set Spazzola e Specchio	304
Smartwatch	335, 336
Sinalini	153-156
Speaker	335, 338, 350, 351
Spinner apribottiglia	164
Stilofofo	30
Stopmaster	384
Spazzole	304-307
Specchietti da Borsa	304-306
Stand di Ricarica Qi	339-345
Stazione Metereologica	337
Supporto Smartphone per Auto	361, 362
Svuotatasche	84, 85

<b>T</b>	
Tagliapizza	165
Taglierini	385
Targhette Valigia	291
Tappi per borracce	117, 119-123, 129, 130, 137
Tazze in Ceramica	138-140
Tazze in Vetro	141-143
Teli	453-457
Tracolle	59, 60, 62-65, 281
Trolley da Viaggio	289

<b>U</b>	
Umidificatore	337
USB Pen Drive	358, 359

<b>V</b>	
Ventagli	307

<b>Z</b>	
Zaini	251-279

## ABBIGLIAMENTO E TESSILE

<b>B</b>	
Bandane	425-427
Berretto Ciclista	424

<b>C</b>	
Camice	450
Canotta unisex	432
Cappelli	417-425, 427-429
Casacca	376, 450, 451
Costumi	433

<b>F</b>	
Fasce per Capelli	429, 430
Felpe	411-416, 438, 439

<b>G</b>	
Gilet	441, 444-446, 448, 449, 451
Giubbini	440-447

<b>I</b>	
Impermeabile	447

<b>P</b>	
Pantaloncino	432
Pile	416, 438, 439
Polo Adulto	408-410, 437
Polo Bambino	437

<b>S</b>	
Sciarpa	
Scaldacollo	

<b>T</b>	
T-Shirt Adulto	404-406, 431, 434, 435
T-Shirt Bambino	406, 407, 436
T-Shirt Donna	434

## TIME

<b>AGENDE</b>	
Agende Blocco Fisso	118-182
Agende Borsello	102, 103, 106, 107
Agende Calamus	150, 151
Agende con Molla	114, 115, 130-133, 136-139, 142, 143, 147, 150, 151, 154, 168-171, 176, 178-181
Agende in Ecopelle	112, 113, 116, 117
Agende in Gommato	156-158, 163-167, 172-177
Agende in Midi Cartonato	168-171, 178-181
Agende in Poliuretano	104-107, 114, 115, 122-135, 144-151, 160, 162
Agende Italy	156-158
Agende Flessibili	114-117, 150, 151
Agende Manager	120-123
Agende Natural	152-155
Agende Spiralate	148, 149
Agende Portafoglio	104, 105, 108-113
Blitz	177
Interni	98, 99
Libro Prenotazioni	160, 161
Notes	183-201
Notes Calamus	191, 192
Notes Natural	183-189
Notes Spiralate	185, 186,
Notes Termoviranti	191, 192
Parure	180-181
Planning Settimanali	158, 159

<b>CALENDARI</b>	
Almanacco Italiano	52-61
Block Notes	100
Calendari Fluorescenti	3, 4
Calendari Illustrati 12 Fogli	62-90
Calendari da Tavolo	35 -51, 91-95
Calendario Magnetico	34
Calendario Mousepad	49
Calendario Planning Settimanale	50, 51
Olandesi Illustrati	12-16
Olandesi Tecnici	5-33
Olandese Passafoglio	19
Planning	98, 97
Trittici	4-7
Silhouette	32, 33, 88-90

COD.	PAG.	COD.	PAG.	COD.	PAG.	COD.	PAG.	COD.	PAG.
<b>01. GIFT</b>		PB594	100	PC434	125	PD050	18	PD508	45
CA026	251	PB599	101	PC435	125	PD051	12	PD511	50
CA031	252	PB600	102	PC436	128	PD055	18	PD517	44
CA033	253	PB603	97	PC437	124	PD058	15	PD518	51
CA035	254	PB607	41	PC438	129	PD062	13	PD519	49
CA037	255	PB607	102	PC456	151	PD063	13	PD521	48
CA039	256	PB611	96	PC466	139	PD071	21, 40	PD522	50
CA043	257	PB614	103	PC467	140	PD072	20	PD523	8, 50
CA046	258	PB616	103	PC467NB	140	PD074	17	PD524	49
CA047	61	PB620	104	PC478	143	PD076	19	PD525	45
CA055	259	PB621	104	PC484	133	PD079	22	PD527	49
CA056	260	PC001	120, 121, 122,	PC487	152	PD080	23	PD529	8, 50
CA065	365		123, 137	PC490	134	PD082	23	PD530	52
CA067	61	PC002	120, 121, 122,	PC493	134	PD083	14	PD532	52
CA069	315		123, 137	PC494	135	PD088	20	PD536	54
CA077	84	PC003	117, 119, 130, 137	PC496	136	PD089	24	PD540	53
CA083	84	PC004	117, 119, 126, 129,	PC500	152	PD090	25	PD545	53
CA600	387		130, 135, 137	PC579	153	PD091	25	PD548	54
CA650	397	PC085TR	157	PC602	154	PD092	26	PD562	55
NK100	405	PC086TR	157	PC605	155	PD104	26	PD563	57
NK101	406	PC087TR	157	PC606	154	PD108	27	PD565	55
NK102	406	PC088TR	157	PC607	156	PD128	28	PD566	55
NK103	407	PC089TR	158	PC608	156	PD152	30	PD568	55
NK150	404	PC090TR	158	PC670	160	PD154	30	PD569	55
NK151	404	PC091TR	158	PC675	160	PD173	29	PD570	56
NK200	408	PC092TR	158	PC690	159	PD194	31	PD572	54
NK201	408	PC290	138	PC696TR	159	PD207	29	PD575	56
NK205	409	PC295	138	PC697TR	159	PD209	32, 40	PD582	57
NK210	410	PC365	141	PC715	165	PD218	33	PD583	52
NK211	410	PC370	142	PC760	161	PD335	34, 40	PE001	314
NK300	411	PC375	142	PC765	161	PD343	33	PE010	311
NK305	412	PC392	145	PC775	162	PD346	35	PE012	311
NK310	413	PC393	144	PC780	163	PD348	36	PE029	312
NK315	414	PC394	145	PC783	163	PD353	36, 40	PE031	312
NK320	415	PC408	127	PC786	162	PD384	37	PE032	314
NK325	416	PC411	126	PC801	164	PD388	37, 40	PE033	316
PA782	111	PC413	127	PC812	164	PD418	42	PE060	320
PA840	71	PC414	116-117	PC815	165	PD419	42	PE067	319
PA842	71	PC415	120, 121	PD011	7	PD462	47	PE069	319
PA844	71	PC416	118, 119	PD022	8, 51	PD480	38	PE075	321
PB495	105	PC417	122, 123	PD025	6	PD485	39	PE076	321
PB569	92	PC418	120, 121	PD026	6	PD488	41	PE077	321
PB575	93	PC419	122, 123	PD030	7	PD491	43	PE078	320
PB576	93	PC421	126	PD031	10	PD494	43	PE079	321
PB577	90	PC426	132	PD032	9	PD495	44	PE080	320
PB581	98	PC427	132	PD041	15	PD497	46	PE095	313
PB582	99	PC428	129	PD043	16	PD499	46	PE096	313
PB583	94	PC430	131	PD044	16	PD501	47	PE100	313
PB587	95	PC431	124	PD045	11	PD503	47	PE113	317
PB588	96	PC432	130	PD046	11	PD504	47	PE118	315
PB589	97	PC433	128	PD048	12	PD505	48	PE123	322

COD.	PAG.	COD.	PAG.	COD.	PAG.	COD.	PAG.	COD.	PAG.
PE124	318	PF225	352	PG036	169	PG140	199	PG202	245
PE126	318	PF256	349	PG037	169	PG143	196	PG203	246
PE133	325	PF258	339	PG038	169	PG145	200	PG206	241
PE134	323	PF259	339	PG039	169	PG146	201	PG207	242
PE136	322	PF266	339	PG040	169	PG147	202	PG210	240
PE137	322	PF267	344	PG041	169	PG148	201	PG211	247
PE138	324	PF269	344	PG051	170	PG150	202	PG213	241
PE143	323	PF277	349	PG052	170	PG151	203	PG214	249
PE144	324	PF279	337	PG053	170	PG152	204	PG216	238
PE235	325	PF286	351	PG054	170	PG153	205	PG218	289
PE358	326	PF288	351	PG055	170	PG154	206	PG235	270
PE359	326	PF289	338	PG061	171	PG156	207	PG240	271
PE360	326	PF301	353	PG062	171	PG157	208	PG241	234
PE392	327	PF304	353	PG063	171	PG158	209	PG242	233
PE398	327	PF306	354	PG064	171	PG159	210	PG244	235
PE401	327	PF307	354	PG065	171	PG160	211	PG245	233
PE402	327	PF314	345	PG066	172	PG161	210	PG246	234
PE405	327	PF316	342	PG067	172	PG162	212	PG248	235
PE846	329	PF323	340	PG068	172	PG163	216	PG251	270
PE848	329	PF325	340	PG069	172	PG165	219	PG261	276
PE852	329	PF330	343	PG070	172	PG166	213	PG265	282
PE858	330	PF331	342	PG071	173	PG167	214	PG267	283
PE859	330	PF333	341	PG073	173	PG168	213	PG271	284
PE863	331	PF334	341	PG075	173	PG170	219	PG273	285
PE864	331	PF336	347	PG077	173	PG171	214	PG274	286
PE865	332	PF337	348	PG079	173	PG173	217	PG278	277
PE867	332	PF338	352	PG080	148	PG174	215	PG279	276
PE868	332	PF345	82	PG081	148	PG175	218	PG280	278
PE915	333	PF387	361	PG088	177	PG176	215	PG281	287
PF012	346	PF389	362	PG091	178	PG177	225	PG293	272
PF014-08	358	PF411	75	PG093	178	PG179	224	PG300	273
PF016	347	PF515	357	PG094	179	PG181	236	PG310	274
PF024	355	PF525	356	PG095	179	PG182	240	PG316	275
PF026	355	PF602	357	PG102	148	PG183	221	PG361	280
PF029	356	PG011	167	PG104	148	PG184	248	PG364	281
PF030	346	PG012	167	PG106	189	PG185	239	PG367	281
PF060	109	PG013	167	PG108	190	PG186	240	PG368	281
PF104-04	358	PG014	167	PG110	191	PG187	242	PG401	220
PF106-04	358	PG015	167	PG111	149	PG188	248	PG402	220
PF108-04	358	PG016	174	PG112	149	PG189	222	PG406	244
PF170	343	PG018	174	PG115	150	PG191	221	PG407	227
PF183	345	PG019	175	PG116	150	PG192	221	PG420	240
PF187	337	PG020	174	PG128	147	PG193	221	PG421	247
PF188	338	PG021	174	PG129	196	PG194	245	PG422	229
PF190	335	PG022	176	PG131	193	PG195	239	PG423	229
PF191	335	PG023	175	PG132	193	PG196	227	PG424	229
PF203	355	PG025	176	PG133	192	PG197	223	PG426	228
PF210	336	PG032	168	PG134	197	PG198	227	PG433	227
PF216	336	PG033	168	PG135	197	PG199	240	PG436	228
PF217	350	PG034	168	PG138	198	PG200	241	PG437	225
PF218	350	PG035	168	PG139	198	PG201	243	PG440	236



COD.	PAG.	COD.	PAG.	COD.	PAG.	COD.	PAG.	COD.	PAG.
PG441	237	PH510	77	PI340	303	PL134	399	PM780	447
PG446	151	PH523	78	PI351	304	PL135	399	PM809	448
PG447	225	PH530	78	PI360	308	PL136	400	PM811	449
PG448	151	PH544	78	PI395	304	PL260	400	PM815	450
PG450	230	PH545	78	PI415	305	PL270	401	PM819	451
PG451	230	PH547	82	PI490	305	PL280	401	PM824	376, 451
PG452	238	PH550	82	PI521	306	PM090	417	PM900	454
PG453	237	PH551	83	PI522	306	PM092	418	PM905	453
PG455	232	PH553	83	PI525	307	PM093	419	PM906	453
PG456	232	PH555	83	PJ100	180	PM101	421	PM911	454
PG462	194	PH585	86	PJ102	181	PM102	420	PM915	454
PG463	194	PH590	86	PJ103	182	PM103	420	PM921	455
PG465	195	PH593	87	PJ104	183	PM105	422	PM925	456
PG466	195	PH598	87	PJ105	182	PM108	423	PM930	457
PG468	192	PH606	88	PJ106	183	PM150	424	PM938	457
PG477	226	PH615	88	PJ107	184	PM155	424	PM940	458
PG480	279	PH616	89	PJ108	185	PM175	425	PM942	458
PG487	231	PH617	91	PJ109	186	PM185	425	PM944	458
PG499	231	PH618	91	PJ112	187	PM188	426	PM946	458
PG500	261	PH619	106	PJ113	188	PM189	426	PN045	362
PG501	262	PH625	106	PJ200	309	PM190	427	PN053	362
PG502	263	PH630	107	PJ300	307	PM192	427	PN057	361
PG503	264	PH633	89	PJ504	79	PM194	429	PN060	363
PG513	265	PH635	107	PJ505	81	PM197	428	PN065	364
PG514	266	PH636	69	PJ506	80	PM199	428	PN083	366
PG516	267	PH640	108	PJ510	80	PM202	429	PN085	364
PG517	268	PH669	109	PJ560	81	PM203	430	PN086	366
PG521	269	PH670	110	PJ580	292	PM210	431	PN098	367
PH106	60	PH679	111	PJ582	293	PM215	431	PN101	367
PH204	59	PH701	85	PJ583	293	PM220	432	PN102	368
PH205	62	PH805	112	PJ585	294	PM225	432	PN150	369
PH222	59	PH810	112	PJ602	294	PM252	433	PN151	369
PH224	64	PH820	113	PJ650	291	PM254	433	PN153	371
PH225	64	PH823	113	PJ700	291	PM301	434	PN154	371
PH234	63	PI210	308	PJ701	290	PM315	435	PN156	371
PH240	65	PI225	308	PJ705	292	PM320	435	PN158	370
PH252	65	PI310	295	PL085	388	PM325	434	PN200	372
PH265	203	PI311	296	PL087	389	PM328	436	PN201	374
PH292	66	PI312	297	PL089	389	PM333	436	PN203	374
PH300	67	PI313	298	PL091	387	PM359	437	PN204	372
PH311	68	PI314	298	PL102	390	PM360	437	PN208	375
PH315	68	PI315	296	PL105	390	PM511	438	PN210	373
PH450	70	PI318	299	PL107	391	PM540	439	PN212	372
PH455	70	PI320	299	PL109	392	PM600	450	PN215	373
PH480	72	PI321	300	PL112	393	PM695	440	PN220	373
PH482	73, 378	PI322	300	PL113	394	PM701	441	PN226	374
PH485	73	PI330	301	PL119	395	PM703	442	PN227	374
PH491	75	PI333	301	PL124	392	PM704	443	PN228	375
PH502	76	PI334	302	PL127	396	PM706	444	PN230	375
PH504	76	PI335	302	PL129	398	PM714	445	PN264	75, 378
PH507	77	PI337	303	PL131	398	PM716	446	PN265	376

COD.	PAG.	COD.	PAG.	COD.	PAG.	COD.	PAG.	COD.	PAG.
PN268	74, 377	PA014	53	PA520	17	PB201	114, 115	PB361	157
PN269	74, 377	PA018	54	PA523	18	PB203	114, 115	PB375	150, 151
PN270	379	PA022	55	PA550	19	PB204	114, 115	PB380	150, 151
PN272	379	PA024	56	PA600	20	PB205	114, 115	PB473	162
PN273	380	PA032	57	PA610	21	PB206	116, 117	PB474	163
PN274	380	PA062	58	PA611	22	PB207	116, 117	PB489	160
PN279	381	PA064	59	PA614	23	PB208	116, 117	PB495	202
PN280	381	PA065	60	PA615	24	PB209	116, 117	PB499	161
PN281	382	PA066	61	PA620	25	PB214	108, 109	PB505	165
PN282	382	PA091	65	PA636	26	PB216	108, 109	PB506	166
PN284	381	PA100	63	PA640	27	PB217	110, 111	PB510	167
PN300	384	PA101	64	PA646	28	PB219	110, 111	PB512	158, 168
PN330	383	PA103	66	PA650	29	PB226	112, 113	PB520	158, 169
PN351	383	PA105	67	PA654	30	PB227	112, 113	PB524	170, 171
PN353	383	PA108	68	PA658	31	PB238	124, 125	PB526	172
PN354	383	PA114	69	PA670	32	PB239	124, 125	PB527	173
PN362	384	PA115	70	PA673	33	PB256	120	PB528	170, 171
PN364	384	PA116	71	PA675	33	PB258	121	PB530	158, 174
PN387	385	PA117	72	PA677	32	PB257	126, 127	PB532	175
PN388	385	PA132	73	PA700	38, 39	PB260	126, 127	PB535	176
PN391	309	PA136	74	PA703	36	PB261	128, 129	PB540	159, 177
PN450	385	PA138	75	PA705	37	PB263	128, 129	PB544	180
US001	359	PA140	76	PA706	3	PB265	130, 131	PB546	181
US002	359	PA142	77	PA710	40, 41	PB266	122	PB550	179
US003	359	PA144	78	PA715	42, 43	PB268	123	PB552	178
US004	359	PA146	79	PA720	44	PB270	130, 131	PB569	185
US005	359	PA148	80	PA725	45	PB275	132, 133	PB572	182
US006	359	PA152	81	PA730	46	PB278	132, 133	PB573	183
US007	359	PA154	82, 83	PA740	47	PB280	134, 135	PB575	186
US008	359	PA160	84, 85	PA745	48	PB281	140	PB576	186
US009	359	PA162	86, 87	PA750	50, 51	PB282	134, 135	PB577	187
US010	359	PA187	88	PA782	48	PB283	136, 137	PB581	194
US011	359	PA189	89	PA785	34	PB284	138, 139	PB582	193
US012	359	PA191	90	PA802	96	PB285	138, 139	PB583	188
US013	359	PA401	92	PA806	97	PB286	136, 137	PB587	189
ZD253	5	PA402	93	PA807	97	PB287	141	PB588	190
ZD260	5	PA403	94	PA840	100	PB288	142, 143	PB589	191
<b>02. TIME</b>		PA406	95	PA842	100	PB289	144	PB590	179
AS010	119	PA420	8	PA844	100	PB290	142, 143	PB594	192
AS020	119	PA422	9	PB001TN	98	PB292	145	PB599	195
AS030	119	PA430	10	PB002TN	99	PB296	154	PB600	196
AS033	119	PA432	11	PB003TN	98	PB298	154	PB603	191
AS040	119	PA450	12	PB004TN	99	PB308	164	PB607	197
AS043	119	PA455	13	PB005TN	99	PB320	148	PB611	190
AS045	119	PA460	14	PB025	102, 103	PB330	147	PB614	198
AS046	119	PA465	15	PB026	102, 103	PB340	148	PB616	199
AS050	119	PA468	16	PB028	104, 105	PB351	149	PB620	200
AS060	119	PA500	4	PB029	104, 105	PB355	152, 153	PB621	201
AS080	119	PA508	5	PB049	106, 107	PB356	152, 153		
AS090	119	PA510	6	PB052	106, 107	PB357	155		
PA012	52	PA516	7	PB200	114, 115	PB358	156		





**promotional concept®**

